



# Manual for On-Site Sewage Management Systems

June 2026

Environmental Health Section

**TABLE OF CONTENTS**

..... 1

**TABLE OF CONTENTS ..... 1**

**INDEX OF TABLES ..... 5**

**INDEX OF FIGURES ..... 5**

**INDEX OF FORMS..... 6**

**INTRODUCTION..... 7**

Format of the Manual .....7

Content of the Manual .....8

Acknowledgements .....8

**ON-SITE SEWAGE MANAGEMENT SYSTEMS RULES ..... 11**

511-3-1-.01 Applicability.....11

511-3-1-.02 Definitions.....11

511-3-1-.03 General Requirements for On-Site Sewage Management Systems.....15

511-3-1-.04 Sewers.....18

511-3-1-.05 Septic Tanks.....18

511-3-1-.06 Distribution Devices and Dosing Tanks.....19

511-3-1-.07 Absorption Fields.....19

511-3-1-.08 Privies.....20

511-3-1-.09 Alternative On-Site Sewage Management Systems.....20

511-3-1-.10 Experimental On-Site Sewage Management Systems.....20

511-3-1-.11 Septage Removal and Disposal.....21

511-3-1-.12 Grease Traps.....22

511-3-1-.13 Sewage Flow.....22

511-3-1-.14 Subdivision and Mobile Home Parks.....22

511-3-1-.15 Technical Review Committee.....23

511-3-1-.16 Certification of Soil Classifiers, Septic Tank Contractors, On-Site Sewage Management System Inspectors, Maintenance Personnel, and Sewage Pumps.....24

511-3-1-.17 Maintenance and Operation.....25

511-3-1-.18 Standards for Non-Conventional On-Site Sewage Management Systems.....25

511-3-1-.19 Decertification and Denial of Renewal.....26

**SECTION B - GENERAL SITE PROVISIONS..... 29**

1) Soil Characteristics .....29

2) Ground Water .....29

3) Bedrock and Impervious Strata.....29

4) Topographical and Other Site Conditions.....29

5) Tables, Figures and Forms.....31

**SECTION C - SOIL INFORMATION..... 33**

1) Preface .....33

2) Introduction.....33

3) Soil Evaluations .....44

4) Soil Investigations.....52

5) Glossary of Soil Terms .....57

6)	Saturated Hydraulic Conductivity Guidance .....	62
7)	Tables, Figures and Forms .....	67
<b>SECTION D - PRETREATMENT .....</b>		<b>94</b>
1)	Preface .....	94
2)	Septic Tank Pretreatment Units .....	94
3)	Precast Concrete Septic Tanks .....	94
4)	Precast Concrete Pump/Dosing Tanks .....	97
5)	Septic Tanks Constructed on Site .....	98
6)	Fiberglass Reinforced Plastic Septic Tanks .....	98
7)	Polyethylene Septic Tanks .....	101
8)	Filtration Devices for Residential Gravity Flow Septic Tank Systems .....	103
9)	Aerobic Treatment Units .....	104
10)	Class I Effluent Systems .....	110
11)	Nitrogen Reduction .....	112
12)	Portable Toilets .....	112
13)	Incinerator Toilets .....	112
14)	Composting Toilets .....	113
15)	Water Saving Devices and Fixtures .....	113
16)	Separate Black Water - Gray Water Systems .....	113
17)	Privies .....	114
18)	Grease Traps .....	114
19)	Septic Tank Riser and Lid Systems .....	116
20)	Tables, Figures, Forms .....	119
<b>SECTION E - EFFLUENT DISTRIBUTION AND DOSING DEVICES .....</b>		<b>127</b>
1)	Preface .....	127
2)	Distribution Devices .....	127
3)	Dosing Devices .....	129
4)	Pumps and Ancillary Equipment .....	131
5)	Tables, Figures and Forms .....	133
<b>SECTION F – DISPERSAL SYSTEMS .....</b>		<b>137</b>
1)	Preface .....	137
2)	Aggregate Absorption Field Systems .....	137
3)	Absorption Field Methods for Conventional Septic Tank Systems .....	139
4)	Chamber Systems .....	142
5)	Wisconsin Mound Soil Absorption System .....	142
6)	Minimum Criteria for Pressurized Subsurface Absorption Fields Utilizing Emitters .....	151
7)	Guidelines for domestic wastewater application for absorption fields designed for Class I effluent .....	155
8)	Tables, Figures, and Forms .....	156
<b>SECTION G - EXPERIMENTAL ON-SITE SEWAGE MANAGEMENT SYSTEMS ...</b>		<b>175</b>
1)	Definition .....	175
2)	Request for Approval .....	175
3)	Technical Review .....	175
4)	Permitting .....	176
5)	Installation .....	176
6)	Record Keeping .....	177
7)	Monitoring and Testing .....	177
8)	Final Disposition .....	177

---

9) Table, Figures and Forms .....	178
<b>SECTION H – SITE MODIFICATIONS.....</b>	<b>181</b>
1) General Guidelines for Filling of Land.....	181
2) General Guidelines for Drainage of Land.....	182
3) Artificially Drained Systems.....	183
4) Subsurface Drainage Problems .....	183
5) Selection of Drainage Method .....	184
6) Mound System Modification .....	185
7) Alternative Distribution System Specifications .....	185
8) Simplified Falling-Head Permeameter Test for Fill Material for Disposal Fields .....	185
9) Tables, Figures and Forms .....	187
<b>SECTION I – SEPTAGE REMOVAL AND DISPOSAL.....</b>	<b>194</b>
1) Septage Removal Permits .....	194
2) Standards for Septage Removal .....	194
3) Septage Disposal.....	194
4) Temporary Storage of Septage.....	194
5) Tables, Figures and Forms .....	196
<b>SECTION J – SEWAGE FLOW SCHEDULE.....</b>	<b>199</b>
<b>SECTION K – FIELD INSPECTIONS .....</b>	<b>203</b>
1) Preface .....	203
2) Request for Inspection .....	203
3) Inspection of Septic Tanks.....	203
4) Inspection of Conveyance Piping .....	204
5) Inspection of Distribution Devices .....	204
6) Inspection of Trenches.....	205
7) Inspection of a Subsurface Emitter System .....	206
8) Inspection of Wisconsin Mound Systems .....	208
<b>SECTION L – OPERATION AND MAINTENANCE .....</b>	<b>210</b>
1) Operation .....	210
2) Maintenance.....	210
3) Performance Evaluation of Existing On-site Sewage Management Systems .....	211
4) Tables, Figures and Forms .....	212
<b>SECTION M – RECOMMENDED LOT SIZING CRITERIA .....</b>	<b>217</b>
1) Lot size requirements.....	217
2) Lot Sizing Non-Single Family Dwellings.....	218
3) Criteria for Protection of Groundwater Recharge Areas.....	219
4) Tables, Figures and Forms .....	219
<b>SECTION N - CERTIFICATION.....</b>	<b>223</b>
1) Preface .....	223
2) Definitions .....	223
3) Basic Requirements for Initial Certification .....	223
4) Additional Certification Requirements .....	224
5) Requirements for Renewal Certification.....	227
6) Certification Exams .....	227

---

7) Certification Fees .....	228
8) Establishment of the Certification Review Committee .....	228
9) Establishment of the Soil Classifiers' Certification Advisory Committee .....	228
<b>SECTION O – APPENDIX.....</b>	<b>231</b>
1) Appendix 1 - Pressure Distribution Network Design.....	231
2) Appendix 2 - Wisconsin Mound Design Example.....	256
3) Appendix 3 - Inspecting Wisconsin Mound.....	260
4) Appendix 4 - Troubleshooting Wisconsin Mound Systems.....	262
5) Appendix 5 - Pathogenic Microorganisms in Domestic Wastewater and the Diseases They Cause .....	269
6) Appendix 6 - Septic Tank System Failure .....	270
7) Appendix 7 - Pipe Fittings .....	282

---

**INDEX OF TABLES**

Table 1.C	Soil Series Suitability Codes.....	67
Table 2.C	Soil Series Suitability.....	68
Table 3.C	Soil Texture.....	82
Table 4.D	Performance Standards/Testing Protocol for Aerobic Treatment Units.....	119
Table 5.F	Recommended Soil and Site Criteria for Wisconsin Mound System.....	156
Table 6.F	Estimated Design Basal Loading Rates.....	157
Table 7.F	Hydraulic Loading Rates for Fields Utilizing Emitters, Class I Effluent.....	157
Table 8.F	Absorption Field Sizing Coefficients for Class I Effluent Systems.....	158
Table 9.F	Percolation Coefficient Calculations for Non-Residential Facilities.....	160
Table 10.F	Residential Trench Absorption Field Sizing.....	160
Table 11.H	Drainage Methods for Various Site Characteristics.....	187
Table 12.H	Use of Subsurface Drains to Control Ground Water Table.....	188
Table 13.J	Sewage Flow Schedule.....	199
Table 14.J	Design Basis for Central Septic Tank Systems.....	201
Table 15.L	Est. Septic Tank Pumping Frequencies (in Yrs) for Year-Round Residences.....	212
Table 16.M	MT-1 Minimum Lot Sizes – Single Family Dwellings.....	217
Table 17.M	MT-2 Minimum Lot Sizes – Non-Single Family Dwellings.....	219

**INDEX OF FIGURES**

Figure 1.B	Slope - Minimum Soil Depth.....	31
Figure 2.C	Georgia Major Land Resource Areas (MLRA's).....	83
Figure 3.C	Example Soil Report: Page 1 of 2.....	83
Figure 4.C	Example Soil Report: Page 2 of 2.....	85
Figure 5.D	Septic Tank Specifications.....	120
Figure 6.D	Aerobic Treatment Unit.....	121
Figure 7.D	Typical Composting Toilets.....	121
Figure 8.D	Standard Grease Trap Detail.....	123
Figure 9.D	Septic Tank to Grease Trap Conversion.....	124
Figure 10.D	Pit Privy Design Detail.....	125
Figure 11.E	Typical Dosing Tank with Pump.....	133
Figure 12.E	Sewage Siphon.....	134
Figure 13.E	Criteria for Drainfields 500 to 1000 Feet.....	135
Figure 14.E	Criteria for Drainfields >1000.....	135
Figure 15.F	Distribution Box System Installation Example.....	161
Figure 16.F	Level Field Installation Example.....	161
Figure 17.F	Serial System Installation.....	161
Figure 18.F	Alternating Drainfields with Diversion Valve.....	161
Figure 19.F	Trench Installation Examples.....	162
Figure 20.F	Central Manifold Distribution Network.....	164
Figure 21.F	End of Manifold Distribution Network.....	164
Figure 22.F	Wisconsin Mound General Diagrams.....	165
Figure 23.F	Wisconsin Mound vs. Area Fill Mound Detail.....	165
Figure 24.F	Effluent Movement – Wisconsin Mound.....	166

---

Figure 25.F	Observation Tube Detail .....	167
Figure 26.F	Sieve Analysis for Acceptable Fill Material .....	168
Figure 27.F	Wisconsin Mound Sloping Site Detail .....	169
Figure 28.F	Wisconsin Mound Level Site Detail .....	170
Figure 29.F	Drip Emitter System Detail .....	171
Figure 30.H	Curtain Drain Detail .....	189
Figure 31.H	Vertical Drain Detail .....	189
Figure 32.H	Underdrain Detail .....	189
Figure 33.H	Side View of Piping Distribution System in a Wisconsin Mound .....	190
Figure 34.H	Falling Head Permeameter Apparatus.....	190
Figure 35.H	Falling Head Permeameter Permeability Chart.....	192

**INDEX OF FORMS**

Form 1.C	Soil Data Record - Percolation, Water Table, and Soil Data .....	86
Form 2.C	Soil Survey Report Check List .....	87
Form 3.C	OSSMS Construction Permit (page 1).....	89
Form 4.C	OSSMS Construction Permit (page 2).....	90
Form 5.C	OSSMS Site Evaluation Request Form.....	91
Form 6.C	Lot Evaluation Record.....	92
Form 7.F	Wisconsin Mound System Worksheet .....	172
Form 8.F	Engineered Site Plan Checksheet.....	173
Form 9.G	Administrative and Monitoring Criteria for an Experimental Sewage System .....	178
Form 10.G	DPH Experimental Sewage System Monitoring Record .....	179
Form 11.H	OSSMS Filled Site Certification Form .....	191
Form 12.I	Waste Removal and Disposal Application and Permit .....	196
Form 13.I	Waste Removal and Disposal Inspection Form .....	197
Form 14.L	Existing On-site Sewage Management System Performance Evaluation Report..	213
Form 15.M	Subdivision Analysis Record.....	220

## INTRODUCTION

A major factor influencing the health of individuals where public or community sewerage is not available is the proper treatment and disposal of human wastes and other sewage, including industrial and processing waste. Many diseases, such as dysentery, infectious hepatitis, typhoid and paratyphoid, and various types of gastrointestinal problems are transmitted from one person to another through the fecal contamination of food and water, largely due to the improper disposal of human wastes. Chemical contaminants affecting individuals through individual drinking water supplies have been attributed to groundwater pollution caused by improper subsurface disposal of on-site sewage. Because of such problems, every effort shall be made to prevent the existence of these and other potential health hazards.

Safe disposal of all wastes, human, domestic and industrial, is necessary to protect the health of the individual family and the community and to prevent the occurrence of nuisances. To accomplish satisfactory results, all such wastes must be disposed of in such a manner that:

1. They will not contaminate any approved drinking water supply;
2. They will not give rise to a public health hazard by being accessible to insects, rodents, or other possible carriers of disease that may come into contact with food or drinking water;
3. They will not give rise to a public health hazard by being accessible to children;
4. They will not violate laws or regulations governing water pollution or sewage disposal;
5. They will not pollute or contaminate the waters of any bathing beach, shellfish breeding ground, stream or lake used for public or domestic water supply, or for recreational purposes; and
6. They will not give rise to a nuisance due to odors or unsightly appearance.

Where public or community sewage disposal systems are not accessible, these criteria can be met by the discharge of sewage to an adequate on-site sewage management system. Such a system can be expected to function satisfactorily if properly designed and installed where soil and site conditions are favorable and properly maintained. Experience through the years has shown that adequate supervision, inspection, and maintenance are required to insure compliance in this respect.

It is the intention of this Manual to serve as:

1. A technical reference to enhance public health protection;
2. A good source of information for professionals and individuals interested in the on-site sewage management program including public health professionals, engineers, scientists, environmentalists, septic system installers, septic tank pumpers, soil consultants, home builders, land developers, and the general public.

### **Format of the Manual**

This Manual is designed to be kept in a loose-leaf three hole binder so that updates, revisions and technical information can be added easily.

## **Content of the Manual**

This Manual is divided into 16 sections: Section A provides the Rules of the Department of Public Health for On-site Sewage Management Systems, Chapter 511-3-1." Section B covers the general soil provisions for on-site sewage management systems. Chapter C discusses the role of soil information and use of soils in sewage treatment and disposal. Sections D through F cover the technical design standards for on-site sewage management systems. Section G describes the concept and process for obtaining permits for experimental systems. Section H discusses site modifications. Section I describes procedures for septage removal and disposal. Section J provides the sewage flow schedule. Section K details field inspections needed before on-site sewage management systems are put into operation. Section L covers operation and maintenance for the systems. Section M discusses lot sizing for development of individual properties, subdivisions, and mobile home parks. Section N provides procedures for certification and de-certification of septic tank contractors, inspection personnel, pumpers, soil classifiers, and maintenance personnel. Section O provides the appendices while Section P provides a list of references.

## **Acknowledgements**

This Manual was prepared with the help of a Task Force created by the Public Health Division of Georgia Department of Human Resources (DHR). We wish to acknowledge the contributions of the Task Force members and particular thanks are due to William E. McGiboney (Environmental Consultant), George McClure of The McClure Company, Inc, Dr. Stephen King (DHR), Ade O. Oke (DHR), James Matheson of Matheson, Ball and Associates, Inc., Susan Reyher of Dougherty County Health Department, Carl W. Johnson (DHR), Bill Fortune of Fortune Concrete Structures, Bob DeHart (DHR), Pat Kurek of Hedgewood Properties, Inc., Ernest Earn of Georgia Environmental Protection Division (EPD), Bruce O'Connor (EPD), Michael R. Smith (DHR), Larry Martin of Newton County Health Department, Thomas Mitchell of Mitchell and Associates Consulting Engineers, Thomas Macfie of Soil Science Inc., David Oberhausen (DHR), Scott Uhlich (DHR), John Tebeau of Columbia County Health Department, Bill McDaniel of Heritage Homes, Inc., Wilder G. Lucas of Georgia On-site Wastewater Association, Inc., Randall S. McCall (DHR), Stan Coppage (DHR), DeWayne Tanner of Chatham County Health Department, Dr. Larry West of the University of Georgia, Tim Kring of Georgia Land Evaluation, Inc., Don Crouch (DHR), Jeff Gary (DHR), Mark Harden (DHR), David Blankenship (DHR), Jim Free of Infiltrator Systems, Inc., Mike Fugate of Sewage Equipment Sales and Services, Inc., Theo Terry of Zabel Environmental Technology, Inc., Tom McCoy (DHR), Larry Walker (DHR), Stanley Mobley of Grady County Health Department, Lewis Tumlin of Bartow County Health Department, Bill Durham of Durham and Taylor Supply Company, Inc., Bill Cole of Cole Concrete Products, Inc. and Alan Rigdon.

We gratefully acknowledge the encouragement and help received from a number of very important individuals, in particularly, Commissioner Tommy C. Olmstead (DHR), Dr. Kathleen E. Toomey, Public Health Division Director, Kenneth Dickson, Interim Director of Environmental Health and Injury Control Branch, James R. Drinnon, Director of Environmental Health Section, Ms. Taryn Trent, former Public Health Division Attorney, Professor Bob Rubin of North Carolina State University, Dr. Jerry Tyler of Tyler and Associates, Inc., Steve Dix and David Click of Infiltrator Systems, Inc., and Ted Miltiades of Georgia Home Builders Association.

We are very appreciative of the valuable assistance provided by Warren Abrahams, Rita Mitchell, Maxine Simpson, Mary Jordan, Eunice R. Campbell, and the staff of Environmental Health Section of Georgia Division of Public Health.

Finally, the authors express their gratitude to numerous reviewers of this Manual, specifically the environmental health professionals from district and county health departments throughout the state of Georgia, and the private sector including members of Georgia On-site Wastewater Association whose generous help improved the content of this Manual.

### **June 2019 Acknowledgements**

The June 2019 updates to the Manual were made based on actions taken by the DPH Technical Review Committee, Certification Review Committee, and the Department's General Counsel.

The updates included reviewing the Manual for consistency of font and formatting, corrections to typos and grammar, and a complete revision of all Tables, Figures, and Forms. The update also included newly adopted language for performing measured saturated hydraulic conductivity tests and a revised plastic riser standard.

The Department and Technical Review Committee greatly appreciate the contributions of the Land Use Standards Committee, as well as the many industry and technical reviewers. Specific acknowledgement, expressed appreciation, and gratitude goes to Chris Kumnick, Thomas Vanderboom, Leslie Freymann, and Emily McGahee for their considerable contributions throughout the process of updating the Manual.



GEORGIA DEPARTMENT OF PUBLIC HEALTH

# Manual for On-Site Sewage Management Systems

RULES OF THE DEPARTMENT OF PUBLIC HEALTH

CHAPTER 511-3-1

ON-SITE SEWAGE MANAGEMENT SYSTEMS

RULES ADOPTED JANUARY 2016

Environmental Health Section

## ON-SITE SEWAGE MANAGEMENT SYSTEMS RULES

### TABLE OF CONTENTS

511-3-1-.01	Applicability
511-3-1-.02	Definitions
511-3-1-.03	General Requirements for On-Site Sewage Management Systems
511-3-1-.04	Sewers
511-3-1-.05	Septic Tanks
511-3-1-.06	Distribution Devices & Dosing Tanks
511-3-1-.07	Absorption Fields
511-3-1-.08	Privies
511-3-1-.09	Alternative On-Site Sewage Management Systems
511-3-1-.10	Experimental On-Site Sewage Management Systems
511-3-1-.11	Septage Removal & Disposal
511-3-1-.12	Grease Traps
511-3-1-.13	Sewage Flow
511-3-1-.14	Subdivision & Mobile Home Parks
511-3-1-.15	Technical Review Committee
511-3-1-.16	Certification of Soil Classifiers, Septic Tank Contractors, On-Site Sewage Management System Inspectors, Maintenance Personnel, and Sewage Pumpers.
511-3-1-.17	Maintenance and Operation
511-3-1-.18	Standards for Non-Conventional On-Site Sewage Management Systems

#### **511-3-1-.01 Applicability.**

This Chapter shall apply to all on-site sewage management systems except those under the jurisdiction of and regulated by the Department of Natural Resources; any public or community sewage treatment system; and other systems subject to shared jurisdiction by Memoranda of Agreement or other agreements.

Authority: O.C.G.A. Secs. 12-8-1, 31-2A-6, 31-2A-11.

#### **511-3-1-.02 Definitions.**

- (a) **“Absorption Field”** means a configuration of absorption trenches installed in a portion of land and used for the absorption and final treatment of sewage.
- (b) **“Absorption Line”** means a pipe line of perforated pipe laid in an absorption trench to serve as a conduit for sewage effluent.
- (c) **“Absorption Trench”** means an excavation in which an absorption line is laid.
- (d) **“Absorption Trench Bottom and Side Wall Area”** means the total interface of bottom and side soil area with undisturbed soils of all absorption trenches in an absorption field and occurring horizontally and downward from the point of distribution into the soil, expressed in square feet.

- (e) **“Aggregate”** means washed gravel or washed stone meeting the Georgia Department of Transportation standards for hardness or other materials approved by the Department that shall be one half inch (1/2”) to two inches (2”) in diameter.
- (f) **“Alternative On-Site Sewage Management System”** means an approved on-site sewage management system which differs in design or operation from the conventional or chamber septic tank system or privy.
- (g) **“Approved” or “Approval”** means compliance with applicable specifications or criteria developed or accepted by the Department.
- (h) **“Auxiliary System”** means a system to serve a portion of a residence, a pool house, or other adjunct facility.
- (i) **“Bedroom”** means any room that is intended primarily for sleeping purposes, as shown on the building plan.
- (j) **“Black Water”** means wastewater generated by fixtures or appliances that come into direct contact with human excreta or solid organic matter, such as toilets, urinals, bidets, kitchen sinks and garbage disposals.
- (k) **“Building Drain”** means that part of the lowest piping of a building drainage system inside the walls of a building, which receives the discharge from soil, waste or other drainage systems and conveys the discharge to the building sewer.
- (l) **“Building Sewer”** means that part of the horizontal piping of a building drainage system beyond the building drain which receives the discharge from the building drain and conveys it to a public sewer, private sewer, on-site sewage management system or other disposal.
- (m) **“Central On-Site Sewage Management System”** means an on-site sewage management system serving more than one building, business, residence or other facility designed or used for human occupancy or congregation on an individual lot or single parcel of land.
- (n) **“Chamber Septic Tank System”** means a septic tank with a chamber system as defined in definition (o) below.
- (o) **“Chamber System”** means a system of chambers with each chamber being a molded polyolefin plastic, arch shaped, hollow structure with an exposed bottom area and solid top and louvered sidewall for infiltration of effluent into adjoining bottom and sidewall soil areas. Chambers may be of different sizes and configurations to obtain desired surface areas.
- (p) **“Conventional System”** means a traditionally used system that is composed of perforated pipe surrounded by gravel or stone masking for the infiltration of effluent into adjoining bottom and side wall areas.
- (q) **“Conventional Septic Tank System”** means any septic tank and conventional system as defined in (p), but does not include alternative or experimental systems.
- (r) **“County Board of Health”** means a County Board of Health organized pursuant to O.C.G.A. § 31-3-1 *et seq.*
- (s) **“Department” or “DPH”** means the Georgia Department of Public Health.

- (t) **“Distribution Device”** means a watertight structure which receives sewage effluent from a septic tank, dosing tank, or other sewage retention device and distributes it in equal portions to two or more absorption lines.
- (u) **“Dosing Tank”** means an approved watertight tank, located after a septic tank or other sewage retention device, to receive and retain sewage effluent, and so equipped as to discharge sewage effluent intermittently to a distribution device, either by pump or by siphon.
- (v) **“Experimental On-Site Sewage Management System”** means any on-site sewage management system proposed for testing and observation, and provisionally approved for such purposes by the Department, but which has not been fully proven under field use.
- (w) **“Failure” or “failed”** means the on-site sewage system constitutes a health hazard by reason of inadequate treatment or disposal of sewage.
- (x) **“Filter”** means an approved device that removes solids or other materials from the effluent that could cause failure of an on-site sewage management system.
- (y) **“Flood Plain”** means a generally flat plain or depression susceptible to being flooded from any source, including small and intermittent water courses and coastal areas subject to intermittent tidal action.
- (z) **“Gray Water”** means wastewater generated by water-using fixtures and appliances that does not come into direct contact with human excreta or solid organic matter.
- (aa) **“Grease Trap”** means a device in which the grease content of sewage is intercepted and congealed, and from which grease may be skimmed or otherwise removed for proper disposal.
- (bb) **“Hardscape”** means any area devoted to a landscape made up of hard wearing materials such as stone, concrete, decking and other similar construction materials.
- (cc) **“Individual Water Supply System”** means a non-public system of piping, pumps, tanks or other facilities, utilizing groundwater to supply a single-family dwelling.
- (dd) **“Lot”** means a portion of a subdivision, or any other parcel of land, intended as a unit for transfer of ownership, or for development, or both. It does not include any part of the right-of-way of a street or road.
- (ee) **“Manual for On-Site Sewage Management Systems”** means the most current version of the technical handbook adopted and periodically updated by the Department in the implementation of this Chapter.
- (ff) **“Mobile Home Park”** means a parcel of land developed for subsequent rental, lease, or placement of two or more mobile homes.
- (gg) **“On-Site Sewage Management System”** means a sewage management system other than a public or community sewage treatment system serving one or more buildings, mobile homes, recreational vehicles, residences, or other facilities designed or used for human occupancy or congregation. Such term shall include, without limitation, conventional and chamber septic tank systems, privies, and experimental and alternative on-site management systems which are designed to be physically incapable of a surface discharge of effluent.
- (hh) **“Percolation Coefficient”** means the ratio of trench bottom area to percolation time, expressed as the allowable rate of sewage application in gallons per square foot per day.

- (ii) **“Percolation Rate”** means the time, expressed in minutes per inch, required for water to seep into saturated soil at a constant rate.
- (jj) **“Percolation Test”** means the method used to measure the percolation rate of water into soil as described in the *Manual for On-Site Sewage Management Systems*.
- (kk) **“Person”** means any individual, partnership, corporation, association, and bodies both political and corporate.
- (ll) **“Physical Development”** means the alteration or improvement of real property, including site preparation, erection of any structure or road, well construction, or installation of on-site sewage management systems.
- (mm) **“Privy”** means a structure and necessary appurtenances used for the sanitary disposal or storage of human wastes without the aid of water carriage. It does not include chemical, composting, portable or incinerator toilets.
- (nn) **“Public Water Supply System”** means a system for the provision of piped water to the public for human consumption, if such system has at least fifteen service connections, or regularly serves an average of at least twenty-five individuals daily, at least sixty days out of the year.
- (oo) **“Septage”** means a waste that is a fluid mixture of partially treated or untreated sewage solids, liquids, and sludge of human or domestic waste, present in or pumped from septic tanks, malfunctioning on-site sewage management systems, grease traps, or privies.
- (pp) **“Sewage Treatment System”** is a system that provides primary treatment and disposal, including absorption field components, devices, and appurtenances intended to be used for disposal of sewage by soil absorption. It does not include a conventional or chamber septic tank system. The system shall be designed to be physically incapable of a surface discharge of effluent.
- (qq) **“Septic Tank”** means an approved watertight tank designed or used to receive sewage from a building sewer and to affect separation and organic decomposition of sewage solids, and discharging sewage effluent to an absorption field or other management system.
- (rr) **“Sewage”** means and includes human excreta, black water, water-carried wastes, and liquid household waste from residences or commercial and industrial establishments.
- (ss) **“Sinkhole”** means a depression in the land surface, generally in a limestone region, which communicates or has the potential to communicate with a subterranean passage developed by solution.
- (tt) **“Site”** means the location where the absorption field will be installed, to include replacement area.
- (uu) **“Soil Classifier”** means a person who has been approved by the Department to conduct soil evaluations to determine suitability of a site for an on-site sewage management system.
- (vv) **“Subdivision”** means any division of a tract or parcel of land into five or more lots, building sites, mobile home sites, or other divisions, resulting in at least one single lot of less than three acres, for the purpose, whether immediate or future, of sale or legacy, and includes resubdivision. It does not include:

1. The combination or recombination of previously platted lots or portions thereof where the total number of lots is not increased and the resultant lots conform to the standards of these rules; or
2. The division of land into parcels, all of which are three acres or more in size with minimum width of one hundred and fifty feet (150') for a distance sufficient to provide an adequate area for the placement of structures and improvements including wells and approved installation of approved on-site sewage management systems.

(ww) “**Well**” means an excavation or opening into the ground by which groundwater is sought or obtained.

Authority: O.C.G.A. Secs. 12-8-1, 31-2A-6, 31-2A-11.

### **511-3-1-.03 General Requirements for On-Site Sewage Management Systems.**

- (1) If public or community sewage treatment systems are not available, the owner of a building, residence, or property that is designed or intended for human occupancy or congregation shall provide an approved on-site sewage management system sufficient for the number of persons normally expected to use or frequent the building, residence or other property for two hours or more.
  - (a) Connection shall be made to a public or community sewage treatment system if such system is available within two hundred feet (200') of the property line, or available in a public right-of-way abutting the property. If a public or community sewage treatment system is to be constructed, or an existing public or community sewer is to be extended to serve a lot, or an approved on-site sewage management system is to be used, then the building sewer shall be installed so that it will insure gravity flow at a self-cleaning velocity throughout. If an existing on-site sewage system fails, immediate connection shall be made to a public or community sewerage system if such a system is available.
  - (b) A residential on-site sewage system of less than two thousand gallons per day that is failing may be exempted from connecting to sewer if the repair or replacement of the system will meet the criteria set forth in the *Manual for Onsite Sewage Management Systems* and has sufficient area and usable soils as determined by the County Board of Health.
  - (c) Any facility that produces a waste stream with BOD<sub>5</sub> (biochemical oxygen demand) and TSS (total suspended solids) higher than 200 mg/L shall be required to pretreat the waste to reduce the BOD<sub>5</sub> and TSS to 200 mg/L or below before disposal through a conventional or chamber septic tank system.
- (2) No person may begin the physical development of a lot or structure where an on-site sewage management system will be utilized, nor install an on-site sewage management system or component thereof, without having first obtained from the County Health Department a construction permit for the installation of an onsite sewage management system.
  - (a) Application for such a construction permit shall be made in writing on forms provided by the County Board of Health. The County Board of Health shall approve or disapprove such application within twenty days after the receipt of a completed application. The application shall include:
    1. Name and address of the owner and the applicant, if other than the owner;

2. Location of property;
  3. Plans and specifications showing the location and design of the proposed on-site sewage management system, including surface and subsurface drainage and piping;
  4. Nature of the facility to be served;
  5. Location of all water supplies, geothermal borehole, or other utilities and trash pits on or off the lot, which will bear upon the location of the on-site sewage management system;
  6. Number of bedrooms in the dwelling, or the number of persons to be served in other types of establishments, or other sewage flow or water usage data;
  7. Soil characteristics, including soil types and capabilities, frequency and evaluations of seasonal high groundwater tables, occurrence of rock and other impervious strata;
  8. Signature of the owner or agent applying for permit; and
  9. Any additional information deemed necessary to determine the suitability of the site.
- (b) The County Board of Health may waive submission of part of the information required for the application if it determines that sufficient information already is available from previously submitted subdivision or mobile home park data, or from other sources, to determine the acceptability of the proposed lot for the installation of an on-site sewage management system.
- (c) Repairs, replacement, or additions to existing systems must be permitted and inspected.
- (d) Any person preparing to modify a lot or structure for the purpose of obtaining a construction permit for the installation of an on-site sewage management system shall submit plans showing the type and extent of modifications. No modifications shall be carried out prior to the approval of the plans by the County Board of Health. Such approval shall be in accordance with the provisions of the Department's *Manual for On-Site Sewage Management Systems*.
- (3) On-site sewage management system construction permits shall be issued only after a site inspection by the County Board of Health shows favorable findings relative to absorption rates, soil characteristics, groundwater, rock, and any other factors which would affect the acceptability of the lot. If a public water supply system is to be used, then no construction permit for an on-site sewage management system shall be issued until the public water supply system is approved.
- (a) Lot suitability and approval will be determined by the criteria set forth in the *Manual for On-Site Sewage Management Systems*. Lots shall be sized according to the regulations of the County Board of Health. The County Board of Health may deny or revoke an on-site sewage management system construction permit upon finding the lot unsuitable or for failure of the applicant to comply with the provisions of these rules. On-site sewage management construction permits shall remain valid for not more than twelve months from the date of issue.
- (b) Issuance of a construction permit for an on-site sewage management system, and subsequent approval of same by representatives of the County Board of Health shall not be construed as a guarantee that such systems will function satisfactorily for a given period of

time; furthermore, said representatives do not, by any action taken in affecting compliance with these rules, assume any liability for damages which are caused, or which may be caused, by the malfunction of such system.

- (c) On tracts or parcels of land of three acres or more, a conventional or chamber septic tank system may be utilized if the percolation rate does not exceed 120 minutes per inch. Percolation rates greater than 120 minutes per inch shall be considered unsuitable for these systems unless the application for the construction permit includes the results of a special study by the Soil Classifier and a site plan from an engineer licensed in the state which demonstrates the adsorption limitations can be overcome by design. All other conditions must comply with the requirements of the regulations for on-site sewage management systems.
- (4) No person may backfill or use an on-site sewage management system until a final inspection has been made by the County Board of Health, and written approval has been issued by the County Board of Health.
    - (a) A copy of the final inspection report of an on-site sewage management system shall be provided to the owner, builder, developer or agent, whichever is appropriate.
    - (b) Grading, filling, digging trash pits or other landscaping or construction activities on the lot subsequent to final inspection by the County Board of Health which may adversely affect the on-site sewage management system shall render the approval void. Removal or alteration of system components after final inspection by the County Board of Health shall render the approval void.
- (5) A conventional or chamber septic tank system must have a septic tank design capacity of not less than one thousand gallons and no greater than ten thousand gallons.
  - (6) If a proposed on-site sewage management system will produce a sewage flow in excess of two thousand gallons per day, then plans, specifications, soil data, and absorption test data shall be submitted to the County Board of Health for the purpose of obtaining a construction permit. This information shall bear the registration number and signature of an engineer licensed in this State. If a proposed on-site sewage management system will produce a sewage flow of two thousand gallons per day or less, then the County Board of Health may accept plans, specifications, soil data, and absorption test data from any person whom it determines to have sufficient knowledge of on-site sewage management system design.
  - (7) Soil evaluations shall be conducted by individuals certified by the Department as meeting the requirements set forth in the *Manual for On-Site Sewage Management Systems*. In addition, the soil classifier, engineer, geologist or other professional approved by the Department shall be required to attach to any soil evaluation submitted to the County Board of Health a copy of a current liability insurance certificate with limits of liability of not less than one million dollars.
  - (8) Soil evaluation reports shall be prepared in compliance with the requirements established by the Soil Survey Report Checklist in Section C of the Department's *Manual for On-Site Sewage Management System*. The County Board of Health shall issue on-site sewage management system permits on sites deemed suitable by soil evaluations conducted in accordance with requirements established by the checklist in Section C of the Department's *Manual for On-Site Sewage Management Systems*. If the County Board of Health finds the soil evaluation is

deficient, then it shall notify the person or entity that submitted the evaluation in writing by mail within 3 business days stating all deficiencies and measures needed to correct deficiencies.

- (9) Engineer designs shall be prepared in accordance with the Engineered Site Plan Checklist in Section F of the Department's *Manual for On-Site Sewage Management Systems* and shall include a copy of the engineer's current professional liability insurance certificate with limits of liability of not less than one million dollars. Engineer designs shall be evaluated within 20 days of submission and a written determination mailed to the applicant within 3 business days of the findings by the County Board of Health. If the permit application is denied due to rejection of the engineer design, then the County Board of Health shall so notify the submitter listing the deficiencies found, the measures needed to correct the deficiencies, and the applicant's right to appeal the decision.
- (10) If an on-site sewage management system, alternative system, or soil fill installation is installed, the installer shall deliver a notice to the owner of such property stating the type of installation, design, and maintenance needs. In the case of newly constructed homes or commercial buildings, such notice must be delivered to new owner by the homebuilder or contractor at the time of conveyance of such property.

Authority: O.C.G.A. Secs. 12-8-1, 31-2A-6, 31-2A-11.

#### **511-3-1-.04 Sewers.**

- (1) Sewers connecting component parts of on-site sewage management systems shall be of sufficient size to serve anticipated flow conditions.
- (2) All solid pipes and fittings used in an on-site sewage management system, beginning at the house, shall be NSF International schedule 40 PVC or equivalent and shall be a minimum of four inches in diameter. Sewers under driveways or similar areas of load or impact shall be of material capable of withstanding anticipated loads or installed so as to provide protection from crushing.
- (3) Sewers, other than perforated pipe or drain tiles used in absorption fields, shall be laid with sealed, watertight, root-resistant joints. Such sewers shall be laid on a firm foundation, shall not be subject to settling, and shall be installed on a grade that will insure a self-cleaning velocity. Where on-site sewage management systems are used, and where installation of building drains and building sewers is not covered by duly adopted local plumbing codes, or in the absence of a local plumbing code or plumbing inspection, the County Board of Health may verify the adequacy and acceptability of all or any portion of the building sewer or the building drain.

Authority: O.C.G.A. Secs. 12-8-1, 31-2A-6, 31-2A-11.

#### **511-3-1-.05 Septic Tanks.**

- (1) Design and Construction. Septic tanks shall provide a minimum of 24 hours of retention and shall be designed and constructed to equal or exceed minimum design and construction criteria set forth in the *Manual for On-Site Sewage Management Systems*. Any person seeking approval of septic tanks to be used in on-site sewage management systems shall submit detailed plans and specifications for tank manufacture and other information as may be required by the

Department. Manufacturers and suppliers are subject to inspection and approval by the County Board of Health or the Department. Both the inlet and outlet tees shall be ASTM 3034 rated or equivalent. In addition, an approved filter shall be installed on the outlet end of the septic tank in compliance with the *Manual for On-Site Sewage Management Systems*.

- (2) Location. No septic tank shall be installed less than fifty feet (50') from existing or proposed wells, springs, sink holes, or suction water lines, and tanks shall be located downgrade from wells or springs if physically possible; less than twenty-five feet (25') from geothermal boreholes, lakes, ponds, streams, water courses, and other impoundments; less than ten feet (10') from pressure water supply lines, or less than ten feet (10') from a property line. No septic tank shall be installed less than fifteen feet (15') from a drainage ditch or embankment. Septic tanks shall be installed so as to provide ready access for necessary maintenance, and should be at least ten feet (10') from hardscape, drives, swimming pools and building foundations. The County Board of Health, after site inspection, may allow lesser separation distances or require greater distances than cited herein due to unusual conditions of topography, site configuration, subsurface soil characteristics, or groundwater interference.
- (3) Capacity. The liquid capacity of septic tanks for single family dwellings shall be one thousand gallons for one, two, three or four bedrooms and 250 additional gallons for each bedroom over four. Septic tank capacity shall be increased by (50%) if a garbage grinder is to be used. Auxiliary systems serving single family residences or other facilities shall be based on the maximum daily flow.
- (4) Compartmented Tanks. Two compartment tanks shall be required. The first compartment shall be at least 2/3 the liquid capacity of the tank.
- (5) Tanks in Series. The County Board of Health may approve the installation of tanks placed in series as equivalent to a single compartmented septic tank. Tanks in series should be single compartment tanks, with the first tank being at least 1000 gallons and equal to 2/3 of the required liquid capacity. When tanks in series are used, they shall be connected with a sealed sewer line, and all sewage shall initially enter the first tank.
- (6) Foundation and Backfill. Septic tanks shall be installed level on a foundation that will prevent settling. Backfill shall be placed so that a stable fill results and undue strain on the tank is avoided. Earth backfill shall be free of voids, large stones, stumps, broken masonry, or other such materials. A minimum earth cover of six inches (6") over the tank is recommended. With proper documentation the County Board of Health may approve less cover. All openings, risers, and manholes shall be constructed so as to prevent the entrance of surface water.

Authority: O.C.G.A. Secs. 12-8-1, 31-2A-6, 31-2A-11.

#### **511-3-1-.06 Distribution Devices and Dosing Tanks.**

- (1) Distribution devices shall be designed and constructed in accordance with minimum design and construction criteria set forth in the *Manual for On-Site Sewage Management Systems*.
- (2) Where required, dosing tanks shall be designed, constructed, and installed in accordance with the *Manual for On-Site Sewage Management Systems*.

Authority: O.C.G.A. Secs. 12-8-1, 31-2A-6, 31-2A-11.

#### **511-3-1-.07 Absorption Fields.**

- (1) Absorption Area. The absorption area shall be based upon the anticipated volume of treated sewage and upon the characteristics of the soil in which absorption fields are to be located as specified in the *Manual for On-Site Sewage Management Systems*. Soil characteristics and other related data, including percolation tests, may be required by the County Board of Health. Absorption areas shall be classified as follows: aggregate, non-aggregate and other.
- (2) Prior Approved Systems. Any “prior approved system” as defined in the Official Code of Georgia Annotated Section 31-2A-11 (a) (4) is approved for installation according to the manufacturer’s recommendation.
- (3) Location. No absorption field will be constructed less than one hundred feet (100') from existing or proposed wells, springs, or sinkholes; less than ten feet (10') from water supply lines and buildings with basements and less than five feet (5') from buildings without basements, other structures, drives, hardscape, and property lines; less than fifteen feet (15') from an embankment, swimming pool foundation, drainage ditch or trash pits; not less than fifty feet (50') from geothermal boreholes and the normal water level of any impoundment, tributary, stream, or other body of water, including ponded areas of wetlands. If the water supply line crosses or comes within ten feet (10') of the absorption field, the water supply line shall be installed at least twelve inches (12") above the top of the aggregate layer of the absorption line, non-aggregate absorption line or other absorption line, and shall be encased in a single length of larger diameter water pipe. No absorption field shall be installed in areas where groundwater, soil characteristics, or adverse geological formation may interfere with the absorption or effective treatment of sewage effluent.
- (4) Minimum Design and Construction for Absorption Fields. Absorption lines and absorption trenches shall be designed and installed in accordance with the minimum design and installation criteria set forth in the *Manual for On-Site Sewage Management Systems*.

Authority: O.C.G.A. Secs. 12-8-1, 31-2A-6, 31-2A-11.

#### **511-3-1-.08 Privies.**

Privies shall be designed and constructed in accordance with minimum design and construction criteria set forth in the *Manual for On-Site Sewage Management Systems*.

Authority: O.C.G.A. Secs. 12-8-1, 31-2A-6, 31-2A-11. .

#### **511-3-1-.09 Alternative On-Site Sewage Management Systems.**

An alternative on-site sewage management system is an on-site sewage management system which differs in design or operation from the conventional or chamber septic tank or privy, and which has been approved by the Department. Alternative on-site sewage management systems shall be designed and constructed in accordance with the minimum design and construction criteria set forth in the *Manual for On-Site Sewage Management Systems*. The Department shall maintain a list of approved alternative on-site sewage management systems.

Authority: O.C.G.A. Secs. 12-8-1, 31-2A-6, 31-2A-11.

#### **511-3-1-.10 Experimental On-Site Sewage Management Systems.**

Experimental on-site sewage management systems proposed for testing and observation may be provisionally accepted for such purposes by the Department's technical review committee, and shall be subject to limitations imposed by the Department's technical review committee.

Authority: O.C.G.A. Secs. 12-8-1, 31-2A-6, 31-2A-11.

### **511-3-1-.11 Septage Removal and Disposal.**

- (1) **Permits.** No person shall engage in the removal or disposal of the contents of septic tanks, pit privies, or other on-site sewage management or experimental systems without having first obtained a septage removal permit issued by the County Board of Health for such activities. The application for such septage removal permit shall be filed in the county where the business's base of operations is located, on forms provided by the Department or the County Board of Health, at least ten days prior to engaging in such activities. The application shall include the business name and address, name and address of the applicant, the manner by which such contents are to be removed, transported and given final disposal, and such other documentation as may be required by the County Board of Health, and including evidence that septage removed and transported will be accepted at approved disposal sites.
- (2) **Suspension, Revocation, or Denial of Renewal.** The permit shall be valid for one year and must be renewed annually. The following are grounds for suspension, revocation, or denial of renewal:
  - (a) A material misrepresentation or omission on an application or manifest;
  - (b) A pending judicial disciplinary action (s) related to the on-site sewage services;
  - (c) A civil judgment against the individual or company related to on-site sewage services;
  - (d) An unfair or deceptive trade practice as defined by Code Section 10-1-393; and
  - (e) A violation of the Department's Rules and Regulations for On-site Sewage Management Systems or the *Manual for On-Site Sewage Management Systems*.A lesser sanction, including probation on specified terms, may be imposed where the circumstances of the violation do not merit suspension or revocation of the permit.
- (3) **Pumping and Disposal Methods.** Approved methods of pumping and disposal of septage from on-site sewage management systems shall be by direct discharge to a system approved by the Environmental Protection Division; these systems include public or community sewage treatment plants, septage handling facilities, or direct land disposal sites. Pumping and disposal shall be in accordance with the requirements of the *Manual for On-Site Sewage Management Systems*.
- (4) **Vehicle Identification.** The name of the person or firm engaging in the removal of septage from on-site sewage management systems and the permit number shall be lettered on both sides of each vehicle used for septage removal purposes. Letters and numerals shall not be less than two inches (2") in height and shall be readily visible.
- (5) **Vehicle Maintenance.** Every vehicle used for removal of septage from on-site sewage management systems shall be equipped with a watertight tank or body and properly maintained. Liquid wastes shall not be transported in open bodied vehicles. All pumps, hose lines, valves, and fittings shall be maintained to prevent leakage.

Authority: O.C.G.A. Secs. 12-8-1, 31-2A-6, 31-2A-11.

### **511-3-1-.12 Grease Traps.**

- (1) Grease traps shall be required for commercial or industrial establishments with on-site sewage management systems if the County Board of Health determines that the amount of grease introduced into the system may exceed 50 mg/l.
- (2) Plans and specifications for grease traps shall be prepared in accordance with minimum design and construction criteria set forth in the *Manual for On-Site Sewage Management Systems* and submitted to the County Board of Health for approval. Effluent from grease traps shall be disposed of in a septic tank and not directly discharged to the absorption field. Grease traps shall be located, installed and constructed so that the temperature of the sewage will be reduced to permit congealing or separation of grease and easy access for cleaning is provided.

Authority: O.C.G.A. Secs. 12-8-1, 31-2A-6, 31-2A-11.

### **511-3-1-.13 Sewage Flow.**

The design sewage flow of an on-site sewage management system shall be determined in accordance with the *Manual for On-Site Sewage Management Systems*. The daily sewage flow may be determined by the Department after due consideration of data submitted by the owner or his agent on design criteria. Calculations will be made on the basis of peak flow and not on long term averages.

Authority: O.C.G.A. Secs. 12-8-1, 31-2A-6, 31-2A-11.

### **511-3-1-.14 Subdivision and Mobile Home Parks.**

- (1) Approval. No person may sell, offer for sale, lease, rent, or begin construction or otherwise begin the physical development of a lot in a subdivision or mobile home park until written approval of plans for water supply and sewage disposal in the subdivision or park has been issued from the County Board of Health. This approval constitutes general acceptance of all lots for development with on-site sewage management systems.
- (2) Pre-development Review. It is recommended that developers considering subdivision or mobile home park development where public or community sewage treatment systems will not be available seek a predevelopment review by the County Board of Health. A predevelopment report which indicates disapproval or tentative approval may be obtained by submitting a boundary plat including a vicinity map, a topographic map, and a soil map and soil descriptions based on a high intensity soil study conducted in compliance with the Department's *Manual for On-Site Sewage Management Systems*.
- (3) Proposals and Plans Required. The following information is required for subdivision and mobile home park proposals:
  - (a) A boundary plat drawn to a reasonable scale which includes:
    1. A vicinity map;
    2. Proposed lots and streets including lot identification, dimensions, building lines and square footage of lots;

3. A topographic map depicted in two foot (2') contour intervals. Additional contour intervals may be required by the County Board of Health.
  4. A soil map and soil descriptions based on a high intensity soil study, Level 3, conducted in compliance with the *Manual for On-Site Sewage Management Systems*;
  5. The location of all present and proposed wells, water systems, water courses, flood plains, sewage systems, structures, right-of-ways, utilities, storm water drainage systems, proposed road and street construction, grading or disturbance plans, setbacks, and easements on the property and within one hundred feet (100') outside the perimeter of the property; and
  6. The name, registration number and seal of the professional surveyor or engineer that prepared the development plan.
- (b) A completed Subdivision Analysis Record on forms provided by the Department.
- (c) A copy of the following documents issued by the Environmental Protection Division of the Department of Natural Resources:
1. The land disturbance activity permit issued by either the Environmental Protection Division, or by a governing authority of the applicable county or municipality certified by the director of the Environmental Protection Division pursuant to the Official Code of Georgia Annotated Section 12-7-8 (a); and
  2. A letter of approval to begin construction of a public water supply system and approving the source of the water supply where a public water supply system is to be utilized.
- (4) Water Supply. Connection to a public water supply system shall be required if available within one thousand (1,000) feet of the proposed subdivision or mobile home park.
- (5) Limits on Use of On-Site Sewage Management Systems for Subdivision and Mobile Home Parks. Approval of subdivisions and mobile home parks utilizing on-site sewage management systems is subject to the following conditions:
- (a) No public or community sewage system is available within five hundred feet (500') of the subdivision or mobile home park;
  - (b) Soil maps, descriptions, and reports compiled by a registered Soil Classifier indicate no soil conditions that would prohibit safe development of on-site sewage management systems; (c) If a public water supply system is to be built and utilized, receipt of a letter (s) from the Environmental Protection Division approving the plans to construct the public water supply system, and approving the source of the water supply.

Authority: O.C.G.A. Secs. 12-8-1, 31-2A-6, 31-2A-11.

### **511-3-1-.15 Technical Review Committee.**

- (1) The Department shall appoint and maintain a Technical Review Committee consisting of no more than fifteen individuals with technical or scientific knowledge relating to on-site sewage management systems. The committee shall approve new systems, periodically review systems performance, assist the Department with the development of standards and guidelines for new technology, assist with the periodic updating of the *Manual for On-Site Sewage Management*

*Systems*, revise the standards and serve as the authority for product approval, evaluation, and the development of installation standards. The Committee shall also maintain a list of approved systems.

- (2) The Committee shall include at least one individual from the following disciplines:
  - (a) A DPH Environmental Health Section staff person who shall serve as the secretary;
  - (b) Local County Environmentalist;
  - (c) Health District Environmentalist;
  - (d) Engineering;
  - (e) Manufacturing;
  - (f) Home Builders Association;
  - (g) Soil Classifier;
  - (h) University/academia;
  - (i) District Health Director;
  - (j) Environmental Protection Division;
  - (k) Well Driller;
  - (l) Georgia On-Site Wastewater Association;
  - (m) Land Developer;
  - (n) Septic Tank Contractor.
- (3) The Committee shall meet as deemed appropriate by the Department.
- (4) The Department shall adopt a fee schedule for the technical review of new products and technology.

Authority: O.C.G.A. Secs. 12-8-1, 31-2A-6, 31-2A-11.

### **511-3-1-.16 Certification of Soil Classifiers, Septic Tank Contractors, On-Site Sewage Management System Inspectors, Maintenance Personnel, and Sewage Pumps.**

- (1) No person shall perform services as a soil classifier, septic tank contractor, inspection personnel, maintenance personnel, or sewage pumper unless that person is currently certified by the Department in that capacity, or is performing services under the personal on-site supervision of someone who is currently certified by the Department to act in that capacity.
  - (a) The qualifications for certification of soil classifiers, septic tank contractors, inspection personnel, maintenance personnel, and sewage pumpers shall be set forth by the Department and published in the *Manual for On-Site Sewage Management Systems*. The qualifications shall be based on education, experience, testing and performance.
  - (b) The Department may suspend or revoke a certification as provided in DPH Rule 511-3-1-.19.
  - (c) Certification shall be renewed every two years and shall be conditioned on meeting continuing education requirements.

(2) The Department shall adopt a fee schedule for certifications and renewals under this Rule.

Authority: O.C.G.A. Secs. 12-8-1, 31-2A-6, 31-2A-11.

### **511-3-1-.17 Maintenance and Operation.**

- (1) Prohibited Discharge. No person shall allow the unapproved discharge or spillage of sewage, nor shall an on-site sewage management system be used or maintained in such a manner as to allow the seepage or discharge of effluent from such system to the ground surface, to a water course, drainage ditch, open trench, canal, storm drain or storm sewer, water well, abandoned well, lake, stream, river, estuary, groundwater, or other body of water.
- (2) Maintenance. The property owner shall be responsible for properly operating and maintaining the on-site sewage management system to increase its life expectancy and prevent failure. Maintenance of the system shall be in accordance with the criteria set forth in the *Manual for On-Site Sewage Management Systems*.
- (3) Additives. No strong bases, acids, or organic solvents shall be used in the operation of an onsite sewage management system.
- (4) Existing System Evaluations. If a performance evaluation of an existing system is conducted, the evaluation shall be performed in accordance with the procedure set forth in the *Manual for On-Site Sewage Management Systems*.
- (5) Abandonment of a Septic Tank. If the use of a septic tank is discontinued, or if the tank cannot be made to comply with the Rules and its further use is prohibited, then the property owner shall either have the abandoned tank pumped out by a certified pumper and fill the empty tank with sand, soil, or rock to prevent entrapment, or have the empty tank removed to make room for a new system component.
- (6) Variances. The County Board of Health may grant variances in the cases of hardship where existing systems are malfunctioning.

Authority: O.C.G.A. Secs. 12-8-1, 31-2A-6, 31-2A-11.

### **511-3-1-.18 Standards for Non-Conventional On-Site Sewage Management Systems.**

- (1) The Department shall review absorption field products that differ in design from the conventional on-site sewage management system. The following standards will be used to determine equivalency to the conventional on-site sewage management system:
  - (a) The design infiltrative surface is the wetted trench bottom area.
  - (b) Due to the combined effects of compaction, contact area and fines associated with gravel aggregate, the effective infiltrative surface area shall be reduced by an estimated 50%.
  - (c) The minimum amount of effective trench bottom infiltrative surface area per linear foot shall be equivalent to the conventional 36-inch wide gravel system.
  - (d) Sidewall area shall not be considered for design reduction. The minimum amount of effective sidewall infiltrative surface area per linear foot shall be equivalent to a conventional 36-inch wide gravel system.

- (e) The minimum storage volume required for a system shall be equivalent to a conventional 36-inch wide gravel system.
  - (f) The design absorption area required is based on the most hydraulically limiting soil horizon that comes into contact with the infiltrative surface of the sidewall, trench bottom, and for a distance 1 foot below the absorption trench bottom.
- (2) The infiltration area for conventional 36-inch wide gravel trench absorption shall be considered to be as follows:
- (a) Sidewall Infiltration Area:  $2 \text{ sq. ft./ft} \times .50 = 1 \text{ sq.ft. / linear foot}$
  - (b) Trench Bottom Infiltration Area:  $3 \text{ sq. ft./ft} \times .50 = 1.5 \text{ sq.ft. / linear foot}$
  - (c) Storage Volume:  $3 \text{ cubic feet / linear foot} \times 7.48 \text{ gallons / cubic foot} \times .35 = 7.85 \text{ gallons / linear foot}$
- (3) Lots approved for development based on a reduction in absorption trench length up to 50% shall continue to be approved and permitted for up to a 50% reduction in absorption trench length provided the lot is part of a recorded plat or part of a preliminary development plan submitted to the County Board of Health within one year of the April 1, 2007 rule adoption. Preliminary plans must include proposed lots and streets with lot identifications, lot dimensions, and square footage; a topographic map with water courses and flood plain identified; a Level 3 soil report; the location of the water supply system, right-of-ways, easements and utilities; and the name, registration number and seal of the professional surveyor or engineer.

Authority: O.C.G.A. Secs. 12-8-1, 31-2A-6, 31-2A-11.

### **511-3-1-.19 Decertification and Denial of Renewal.**

- (1) The Department may revoke the certification of any person or entity under the Chapter, or may deny certification, for any of the following reasons:
- (a) A violation of Title 31 of the Official Code of Georgia or the Rules of the Departments;
  - (b) An unfair or deceptive trade practice as defined by Code Section 10-1-393;
  - (c) Performing services which a certification is required if, at the time of the service, the person or entity lack a current certification;
  - (d) A material misrepresentation or omission on any application for certification or renewal;
  - (e) A criminal conviction, including a plea of nolo contendere, for any felony, crime of moral turpitude, or offense related to on-site sewage services;
  - (f) Failure to pay certification or renewal fees;
  - (g) Failure to maintain continuing education credits required by the Department;
  - (h) A civil judgment based on conduct related to on-site sewage services; or
  - (i) Such other conduct as, in the opinion of the Department, would render continued certification of the person or entity a threat to the health or safety of the public.

- 
- (2) The Department may, in its discretion, impose a lesser sanction where the circumstances of the violation do not merit revocation of the certification, including suspension or probation on specified terms.
- (3) Procedure.
- (a) The Department may, but is not required to, refer information concerning a certified person or entity to the Certification Review Committee. The Committee shall review the evidence and make a recommendation to the Department.
  - (b) The Department shall give written notice of any disciplinary action taken pursuant to this regulation by certified mail or statutory overnight delivery to the last known address of the person or entity. The notice shall set forth the facts which support disciplinary action.
  - (c) Upon request made in writing and received by the DPH Office of General Counsel no later than twenty days after the written notice of disciplinary action is mailed, the Department shall refer the matter to the Georgia Office of Administrative Hearings for hearing in accordance with its rules. The burden of proof shall be on the person or entity seeking the hearing.
- (4) Effective date of disciplinary action.
- (a) All disciplinary actions by the department are effective twenty days after the certified person's receipt of the notice, unless otherwise specified in the notice, or unless the certified person makes a timely request for a hearing.
  - (b) Upon a written finding set forth in the notice of disciplinary action that the public safety, health, and welfare imperatively require emergency action, the suspension of the certification shall be effective immediately upon issuance of the notice.
- (5) Upon request for exculpatory, favorable, or arguably favorable information relative to pending allegations involving disciplinary action, the Department shall either furnish such information, indicate that no such information exists, or provide such information to the hearing officer for *in camera* inspection pursuant to O.C.G.A. § 50-13-18 (d) (2).

Authority: O.C.G.A. Secs. 12-8-1, 31-2A-6, 31-2A-11.



# Manual for On-Site Sewage Management Systems

## SECTION B | GENERAL SITE PROVISIONS

Environmental Health Section

---

## SECTION B - GENERAL SITE PROVISIONS

### 1) Soil Characteristics

On-site sewage management system construction permits shall be denied where soil studies, soil types, on-site investigations or other geological data indicate soil conditions which preclude safe and proper operation of an on-site sewage management system or when the installation of a system would create an actual or potential health hazard. Soil survey maps and reports prepared on the usual broad scales of 1:15840 feet or 1:20000 feet are not sufficient to approve property for development with on-site sewage management systems. On-site analysis of soils is required to validate the soil data before construction permits can be approved or denied.

### 2) Ground Water

On-site sewage management system construction permits for conventional or chamber septic tank systems shall be denied where the seasonal high ground water elevation is less than two feet below the bottom of the proposed absorption field, or pit for a privy, or less than one foot where aerobic pretreatment of the effluent to Class I quality is used. Water table elevations will be determined by criteria established in Section C of this Manual.

### 3) Bedrock and Impervious Strata

On-site sewage management system construction permits for conventional or chamber septic tank systems shall be denied where bedrock or other impervious strata are less than two feet below the bottom of the proposed absorption field, or pit for a privy, or less than one foot where aerobic pretreatment of the effluent, to Class I quality, is used.

### 4) Topographical and Other Site Conditions

- A. *Fill* - Areas consisting of fill shall be excluded from consideration for use of conventional or chamber septic tank systems unless the County Board of Health, after consideration of special studies, allows the use of a controlled, uniform fill of permeable soil, interfaced with the original permeable soil, and provided that the infiltrative surface of the absorption trench is located in the original soil or in a fill that meets the above requirements. A Soil Classifier, Registered Engineer or Registered Geologist shall certify that the in-place fill meets the requirements in Section H of this Manual or with County Board of Health approval, a Level II Certified Environmental Health Specialist trained in fill evaluation may approve in-place fill meeting the requirements in Section H of this Manual.
- B. *Cuts and Grading* - If grading, cuts, ditching, trenching or other modifications planned for the site will ultimately affect the vertical location of the proposed absorption field in the soil, soil evaluation and percolation tests are to be made after alterations have been completed. This is done so that tests will be conducted in soil of the same characteristics and at the same depth at which the absorption field will be installed.

- C. *Slope* - The suitability of the area to be used for the proposed absorption field with regard to slope shall be determined by consideration of lateral flow of effluent to the surface of the slope. Slopes of more than 25 percent shall be considered unsuitable unless the application for the construction permit includes the results of a special investigation by a soil classifier, which demonstrates that the slope limitation can be overcome by design or by site modifications. See Figure 1.B.
- D. *Drainage* - Areas with gullies, ravines, dry stream beds, natural and man-made drainage ways, sink holes and/or other similar conditions shall be excluded from consideration for any on-site sewage management system utilizing soil absorption as a method for final disposal. Areas subject to frequent flooding should not be considered for installation of on-site sewage management systems.
- E. *Replacement area requirements for lots approved for single family home development with an onsite sewage management system prior to April 1, 2008* – As determined by the local board of health, where special soil studies and engineered site plans indicate suitability, replacement area shall at least be equivalent in size to the primary onsite sewage management system absorption field. Site specific soil permeability tests and data may be required to determine site suitability. This provision does not waive lot sizing requirements as adopted by local county boards of health.

5) Tables, Figures and Forms

Figure 1.B Slope - Minimum Soil Depth

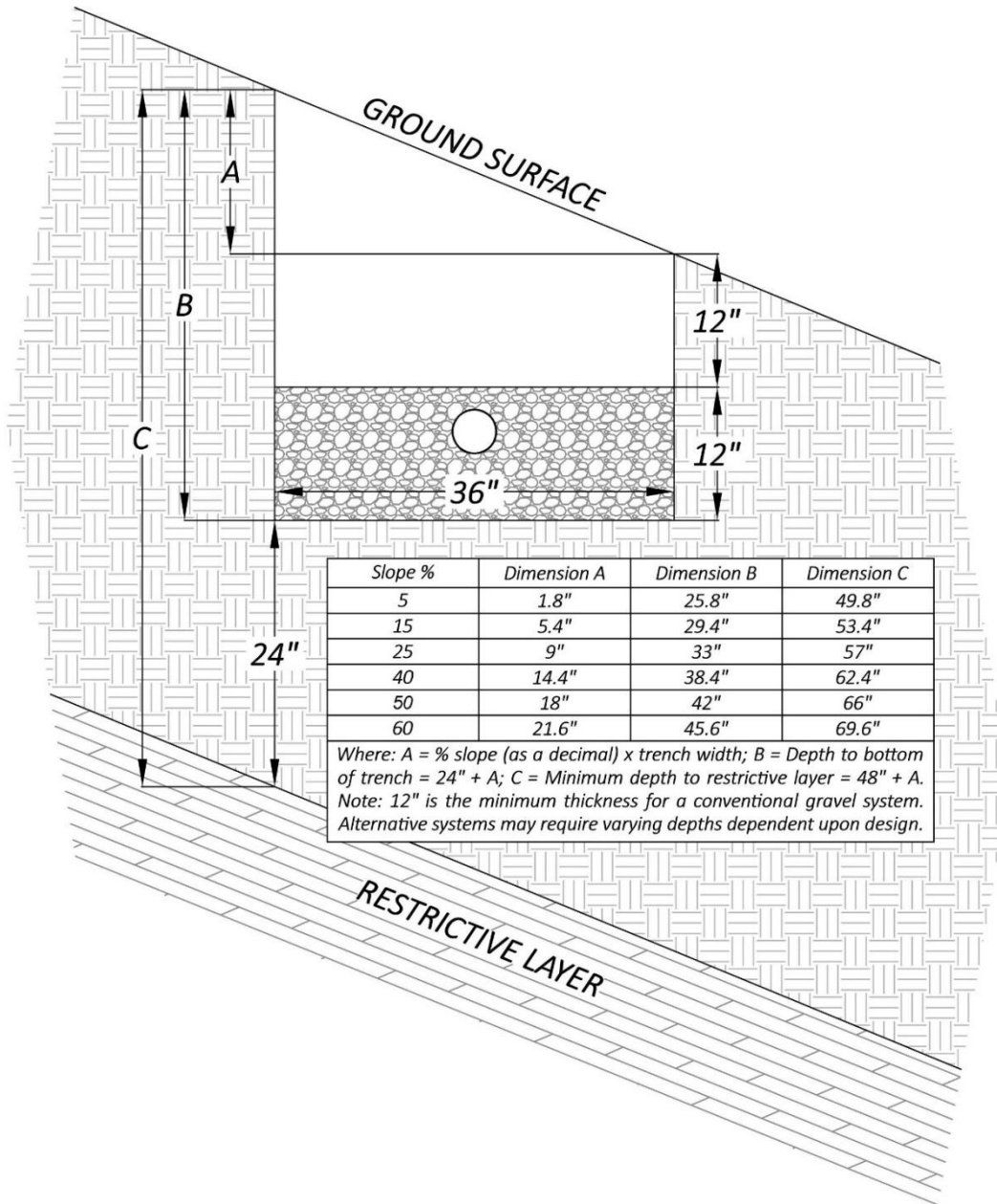



# Manual for On-Site Sewage Management Systems

## SECTION C | SOIL INFORMATION

Environmental Health Section

---

## SECTION C - SOIL INFORMATION

### 1) Preface

Soil information and its proper application can contribute to the solution of many waste disposal problems in Georgia. It can effectively be combined with geology, engineering and ecology to yield an integrated approach to environmental improvement. This Manual concentrates primarily on evaluating the suitability of soils for disposal of liquid waste from individual homes through septic tanks and subsurface soil absorption systems.

It is hoped that the following information will help to point out how to avoid the mistakes frequently made in choosing suitable development sites where the soil is to be used for treatment and disposal of liquid waste. Such mistakes can result in increased land use conflict, environmental degradation and a waste of time and money.

Although these sections of the Manual were developed to provide information to all people interested in solving relevant waste disposal problems where soil characteristics are contributing factors, the majority of the material will probably be most useful to environmental health specialists and other environmental health workers, surveyors, engineers, developers and other persons and groups frequently confronted with making significant land use decisions.

### 2) Introduction

A. *Soil and Environmental Health* - Soil is a term that means different things to different people. To some it is a material in which plants grow in a yard or a field. To some, the color of the soil is important and they speak of red soil, yellow soil or blue clay. To others, the soil texture is important and they speak of sandy soil, clay soil, light soil or heavy soil. To some the soil is everything above hard rock and to others it is the plow layer. Thus, a part of soil evaluation deals with communicating exactly what is meant by the terms “soil”, “soil types” and “soil characteristics.”

The soil scientist, who deals with the genesis and morphology of soils, thinks of soil as that part of the unconsolidated mantle (parent material), covering the surface of the earth, that has been acted on by the forces of climate and vegetation, on a given relief, over a period of time, to form a separate and distinct body (soil profile). Thus, the soil reflects the natural environment of a unit of landscape. By observing the soil characteristics of a given unit of landscape and knowing the environmental conditions that produce such characteristics, a prediction of the problems of the natural environment can be made.

The rapid expansion of the population and its migration into urban and suburban areas has created the need for environmental predictions for planning purposes. A house and lot constitute the environment within which a family makes their home. Such conditions as extremes of wetness or soil permeability on a home site exert a strong influence on the environmental health of the family living on that site. Dampness, ponded water, flooding around or under a house, use and failure of conventional septic tank systems, cracked foundations and the inconveniences that go with these problems, are a direct outgrowth of the soil-water relationship on a lot or within a subdivision.

Problems with environmental health associated with soils result from errors in man's attempt to modify his environment. These errors are generally made by failing to predict soil suitability and in making allowances for modifications or corrective measures. For example, the natural environment of a lot changes in terms of wetness throughout the year and from year to year with changes in the weather. Thus, an evaluation of the wetness of a lot based on the presence of free water in the soil can be expected to vary throughout the year.

Prevention of environmental health problems associated with soils and waste disposal requires prediction of the problems before development begins. Prediction of the problems allows for modifications to be considered prior to development. Corrective measures made after development are more costly, as well as inconvenient to the homeowner or developer. The use of modifications or corrective measures raises the cost of development of a site in terms of initial investment, in terms of maintenance required and in terms of the end result obtained.

Evaluation of land from an environmental health viewpoint requires an understanding of the problems associated with a given unit of landscape (soil study) and an understanding of the processes of conventional septic tank systems.

- B. *On-Site Disposal of Liquid Wastes* - Wastewater (sewage) contains many substances that are undesirable and potentially harmful. Present are pathogenic bacteria, infectious viruses, putrescible organic matter, toxic chemicals and excesses of the nutrients nitrogen and phosphorus. Any of these could create public health hazards and nuisances if the wastes were discharged into the environment without proper treatment. To protect the public and the environment, wastes must be treated and disposed of in a safe and effective manner.

*Characteristics of Household Wastes:* Normal household sewage consists of all the liquid household waste, including waste from the toilet, bath, kitchen and laundry. This is composed of about 99.9 percent liquids and about 0.1 percent solids. The small percentage of solids is responsible for nuisances and, along with the microorganisms in sewage, is the cause of health hazards. Approximately two-thirds of the solids are of organic composition. The remainder is inorganic.

The organic compounds are the primary cause of odors and the nuisance problems attributed to sewage. These are the compounds that require large volumes of oxygen to make them stable, inoffensive, and non-hazardous. Organic compounds in sewage are divided into three groups: nitrogen compounds, carbohydrates, and fats. Nitrogen compounds include proteins, amino acids, amines, peptone, urea, etc. The carbohydrates include sugars, starches, cellulose, etc. The fats include fats, oils, grease, soaps, detergents, etc.

The total solids in sewage consist of dissolved (or soluble) solids, suspended (or colloidal) solids, and the heavier settleable solids. The dissolved and suspended solids remain in the sewage and do not settle out, while the settleable solids are removed from the sewage by gravity. In raw sewage, about 20 percent of the total organic solids are dissolved (soluble) solids. In aged sewage (after 24 hours in a septic tank), the dissolved solids increase to about one-half or slightly more of the total solids initially in the sewage. This is a result of the bacterial action on the suspended and settleable solids.

*Treating the Wastes:* A successful on-site sewage management system is one which will render the wastes harmless while not allowing harmful pollutants to accumulate to dangerous levels in the environment. It is important to point out that the environment is the part of the system providing the final treatment necessary before the water is of a suitable quality for reuse. It is a stream in the case of a municipal treatment plant and the soil in the case of a conventional septic tank system. If the pollutant load received by the environment is too great, pollutants will not be broken down and they will accumulate, leading to failure of the system.

The environment will perform three functions in the treatment of wastes. It will, (1) tie up inorganic compounds by chemical adsorption in the soil and sediments or by plant or animal uptake, (2) dilute the waste concentrations by the addition of purer surface water or groundwater and (3) break down the wastes and recycle the constituents. The ultimate goal of any wastewater treatment and disposal system is to perform the latter function.

To design a safe and effective wastewater treatment and disposal system, it is necessary to evaluate the physical characteristics of the local environment where discharge of the partially treated wastewater is to be made. Each site has its own characteristics that limit its potential as a treatment medium. This is particularly critical where on-site sewage management systems are necessary. On-site systems lack the advantage of public or community sewage systems, where wastes can be collected and conveyed to a treatment plant located at a site, which is selected for its suitability to receive the wastes. Thus, there are fewer restrictions for sites serviced by a public or community sewage system. On-site systems, on the other hand, must be located near the point of waste generation and local environmental conditions are often less than optimal. The result is that development must often be prohibited or other means of disposal found.

*Conventional Septic Tank Systems:* Traditionally, the septic tank-soil absorption system has been used to provide on-site treatment and disposal of liquid wastes. It is an ideal system for disposal of liquid wastes since it is simple, relatively maintenance free and inexpensive when compared to public systems. When properly designed, installed and maintained, it is a very satisfactory system.

In general, the septic tank is used to provide partial treatment of the raw wastewater. Its primary purpose is to protect the soil absorption system from becoming clogged by solids suspended in the raw wastewater. The wastewater is discharged from the home directly into the tank where it is retained for a day or more. During this time, the larger solids settle to the bottom, where a sludge blanket develops. The greases, oils and other floating particles rise to the top to form a scum layer.

In addition to acting as a settling chamber and providing storage for the sludge and scum, the septic tank also digests or breaks down the solids that have been removed. Anaerobic bacteria, organisms that live without oxygen, feed on the sludge and reduce its volume. In the process, soluble organic matter is released from the sludge into the effluent. Methane and carbon dioxide gases are also produced which are vented from the tank through the house plumbing vent. Only about 40 percent of the sludge volume can be reduced in this manner, however and about once every three to five years it is advisable to pump the tank to remove the accumulated solids. If this is not done, the tank will fill with sludge to the

point where the settled solids will be suspended and washed out into absorption fields, where they can quickly clog the soil pores.

The clarified liquid flows from the septic tank to the soil absorption field for secondary treatment and final disposal. It is an odorous liquid, high in partially degraded waste constituents, suspended solids, organic matter, ammonia and nitrogen. Pathogenic (disease-causing) bacteria and viruses may also be present in high numbers, as indicated by the incidence of fecal coliforms.

However, the conventional septic tank system has no process designed specifically to destroy pathogenic organisms. Should any pathogenic organisms be present in the sewage, they may be removed by the sedimentation process or be killed by the septic conditions existing in the septic tank. However, a large number of any pathogenic organisms present initially in the sewage are carried out of the tank in the effluent. Since the system has no chlorination process, the destruction of these remaining pathogens, as well as the oxidation of the effluent, must be accomplished in the soil. These pathogenic organisms gradually die off or desiccate as the effluent filters through the soil, but during this time they are carried for varying distances. The smaller organisms, especially the viruses, may be carried for great (although unknown) distances. The movement of viruses seems to depend on soil moisture and with high water tables and saturated soil conditions; viruses may move a considerable distance. In one New York state study, it was found that viruses are able to travel more than 200 feet in sandy soils.

Primary and secondary treatment of sewage has the same goal, whether the treatment occurs in a sewage treatment plant, an oxidation pond or an on-site sewage management system. That goal is the destruction of all or most of the pathogenic organisms and the removal by oxidation of the organic matter and other detrimental chemical compounds in the sewage. The main difference is that in a sewage treatment plant, the treatment is controlled and regulated by man through the use of various pieces of equipment. In the on-site sewage management system, the treatment is dependent entirely upon natural processes. Once the system has been installed, man has virtually no control over the functioning of the system and can do little to regulate the treatment processes that are occurring naturally. A certain amount of preventive maintenance can be provided, but, except for removal of accumulated solids from the tank, this is only to avoid external interference.

For this reason, the conditions under which a system is installed must be the most favorable to the functioning of the system. This includes not only the construction of the system, which is controlled by man, but also the natural factors, such as soil conditions, slope of the land, drainage, water table, etc., that are not controlled by man but can be selected by man. The selection of these natural factors is as important to the proper functioning of the absorption field as is the selection of the proper equipment in a sewage treatment plant.

The conventional septic tank system uses sedimentation and anaerobic decomposition in the tank and oxidation in the absorption field to treat the sewage. The two types of treatment occurring in the tank take place at the same time and are counter to each other. The settleable solids in the sewage settle to the bottom of the tank, removing about 35 percent of the solids through putrefaction and fermentation. This decomposition produces large amounts of gases, which tend to stir up the contents of the tank as the gases rise to the top.

Because of the rising gases, many of the fine particles which would otherwise settle out, remain suspended in the liquid sewage and are carried out to the absorption field in the effluent.

To a large degree, the amount of solids being carried out to the absorption field in the effluent is determined by the accumulated solids in the tank. The tank will never clog completely as long as effluent is carried out to the absorption field. As the accumulated solids gradually build up in the tank, they increase in the effluent. To some extent, the amount of solids in the tank and in turn in the effluent being carried out to the absorption field can be reduced by increasing the retention time in the tank. This can be done by using a larger tank. When the tank has reached its capacity and can accumulate no more solids, the amount of solids in the effluent will equal the amount of solids in the raw sewage coming into the tank minus those solids that are lost by decomposition. The solids leaving the tank in the effluent are in direct proportion to the accumulated solids in the tank and to the solids in the raw sewage coming into the tank.

The solids being carried out in the effluent can be held to a minimum by having the tank frequently cleaned, i.e., by having the tank pumped to remove the accumulated solids. Except for cleaning the tank, other maintenance is not required. While several septic tank cleaners and other chemicals are on the market to assist the decomposition process occurring in the tank or in the absorption field, these serve no useful purpose. The decomposition process that occurs in the tank is a natural process carried out by anaerobic bacteria and requires no outside chemical assistance. The aerobic process occurring in the absorption field requires only oxygen, in addition to the bacteria present, for the decomposition process to take place. Chemicals currently on the market do not significantly aid the process and also may have some adverse effects on the system. In fact, some products break down or loosen the sludge layer in the septic tank, which is then flushed into the absorption field and causes premature clogging.

Chemicals such as magnesium and calcium tend to keep the soil open so that the effluent can be absorbed more readily by the soil. However, magnesium compounds are poorly soluble. When combined with the sewage or the effluent, these form compounds that are not readily soluble so that their ions are not readily liberated. This reduces their effectiveness in opening the soil. Sodium and potassium compounds are very soluble so that their ions are readily available. However, these have an opposite effect from magnesium and calcium ions, causing a breakdown in the soil, which increases the chances of clogging. In either case, a relatively large amount of the chemical is needed to cause an effect. If any benefits are derived by the use of the chemicals, it is only on a temporary basis and will not be a solution to any problem.

“Seeding the tank” with anaerobic bacteria is another aid that has been advocated in starting the bacterial process of a new tank. This is done by placing old sewage or sludge or manure in the new tank so that the anaerobic process will begin immediately. However, raw sewage coming into the tank from the building initially contains sufficient anaerobic and facultative bacteria so that the seeding is not necessary, although it has no adverse effects.

Raw sewage initially contains three to five parts per million (ppm) of free oxygen and is acted upon by aerobic and facultative bacteria. This oxygen in the sewage is derived from the liquid waste (wash water, kitchen sink waste, bath waste, etc.) rather than from the

human waste. However, the oxygen is soon used up by the aerobic bacteria and the less efficient facultative and anaerobic bacteria become more active. At this point, the sewage becomes septic.

Sewage contains an abundance of nutrients and water, providing an excellent microbiological medium for the growth of bacteria. Raw sewage contains from 100,000 to 1,000,000 bacteria per milliliter. This increases to 10,000,000 to 10,000,000,000 per milliliter in aged sewage. The strictly aerobic bacteria cannot grow in stale or septic sewage and tend to die off. However, many of the strict aerobes are spore formers and exist in the stale or septic sewage in their dormant stage. The majority of the bacteria are facultative and grow in septic as well as raw sewage. These bacteria also grow in the sewage effluent that passes through the tank into the soil. Other microorganisms in sewage include protozoa, fungi, nematodes and viruses. The amoebae are the major intestinal protozoa and exist in the sewage in the cyst stage. Although the yeasts are facultative or anaerobic, most of the other fungi, including the molds and the non-intestinal protozoa, are aerobic. The aerobic organisms tend to die off in the septic sewage or occur in the cyst stage. In this stage they are largely unaffected by the septic conditions. Since the viruses grow only in living cells they do not increase in the septic tank or in the effluent in the soil. Instead, they tend to die off over a varying but usually long period of time.

Many genera of bacteria are present in septic sewage. Among the acid producers, *Alcaligenes*, *Aerobacter*, *Escherichia*, *Flavobacterium* and *Pseudomonas* are the most numerous. These are facultative and are also active when the effluent is oxidized. A few of the anaerobes are also acid producers. The methane formers are less numerous and are strict anaerobes. These include species of the genera *Methanobacterium*, *Methanococcus* and *Methanosarcina*, although other species produce methane as one of their end products. The *Desulfovibrio* species are strict anaerobes and are important in the reduction of sulfur compounds. Their end product is hydrogen sulfide, which may react with existing metallic ions to form other sulfides, most of which are insoluble.

Since anaerobic bacteria must derive their oxygen from organic matter, they must utilize a larger amount of organic matter than do aerobic bacteria, but their decomposition processes are not as complete as those of aerobic bacteria. The anaerobic decomposition processes, because of the limited source of oxygen, are much slower than are the aerobic decomposition processes. Because of this and the short time that sewage remains in the septic tank, the decomposition of organic matter is incomplete and must be completed through the oxidation processes in the soil.

In the putrefactive and fermentative processes that occur in the tank, the solids are broken down into inorganic compounds, liquids and gases. In addition to these, many of the solids initially in the sewage remain in the effluent since these processes are not carried to completion due to the slow action of the anaerobic bacteria.

The solids that do remain tend to be converted to suspended and dissolved solids. While many settleable solids still remain in the effluent, they are of a smaller size than are the settleable solids in the raw sewage. These factors make the septic tank an inefficient means of sewage treatment.

The 40-50 percent of nitro-organic compounds (mainly proteins, amino acids and amines) is reduced primarily to simpler compounds (methane gas, ammonia and ammonium

compounds) through the process of ammonification. Fermentation of the 40-50 percent carbohydrates (starches, sugars, cellulose, etc.) is partially carried out with the liberation of large quantities of methane, hydrogen sulfide and carbon dioxide gases. The sugars and starches are quickly acted upon by the bacteria. The cellulose, however, is fermented much more slowly and receives only minimal bacterial decomposition while in the tank.

The sulfur compounds are acted upon by sulfur bacteria (species of *Clostridium*, *Proteus*, *Senatia*, etc.), which produce hydrogen sulfide or other sulfides from organic sulfur compounds. These sulfides, including dissolved hydrogen sulfide gas, are carried out to the absorption field along with the compounds not acted upon. Detergents, soaps, fats, greases and small amounts of other chemicals that are present in the sewage are acted upon very little by the bacteria in the tank. Those that do not rise to the top of the tank as scum are carried to the absorption field in the effluent.

The nitrogen cycle, the carbon cycle, the phosphorus cycle and the sulfur cycle are all essential in nature for the decomposition and the reuse of essential materials. They are also essential in the treatment of sewage, whether this treatment is in a treatment plant or in an on-site sewage management system. In the conventional septic tank system, these cycles have their beginnings in the septic tank under anaerobic conditions. The cycles are completed only under aerobic conditions in the absorption field. Aerobic conditions must be found in the soil in the absorption field or these cycles are incomplete and the organic and inorganic matter remains in the unstable and offensive state.

In the nitrogen cycle, the nitrogen compounds (proteins, amino acids, amides, urea, etc.) are partially decomposed into ammonia, methane gases and into ammonium compounds in the septic tank under anaerobic conditions. This cycle is continued in the absorption field where the compounds are oxidized first into nitrites and then into nitrates. The cycle is completed when plants absorb the nitrates out of the soil and convert them into plant protein. A continuation of the cycle is the conversion of the plant protein into animal protein. However, in the area of the absorption field only part of the nitrates is taken up by the plants. The remainder stays in the soil. Nitrates are generally considered quite mobile in soils and can be leached out in the groundwater as well as taken up by plants. Private water supplies in the vicinity of absorption fields will sometimes contain nitrates. The concentration of the nitrates in well water is variable and is dependent upon the porosity of the soil, the concentration of the nitrogen compounds in the sewage, the amount of nitrates absorbed by the plants and the distance of the water supply from the absorption field. A high concentration of nitrates in drinking water should be avoided. A maximum contaminant level of 10 milligrams nitrates per liter of water has been set by the Environmental Protection Division, Georgia Department of Natural Resources.

The oxidation of ammonium compounds to nitrites and nitrates is the nitrification process. In the absence of oxygen, the reverse process is brought about by anaerobic bacteria and the nitrates and nitrites are reduced to ammonium compounds.

The sulfur cycle is also reversible. The sulfur compounds in the sewage are decomposed to hydrogen sulfide and to other sulfide compounds under anaerobic conditions in the tank. In the absorption field, in the presence of oxygen, the sulfur bacteria oxidize these compounds first to sulfites and then to sulfates. Under anaerobic conditions in the absorption field the sulfites and sulfates are reduced to sulfides. Hydrogen sulfide or other

sulfides present in the effluent remain unchanged if anaerobic conditions exist in the absorption field. The black odorous substance associated with malfunctioning or poorly functioning absorption fields is ferrous sulfide. The presence of this product in an absorption field indicates the lack of sufficient oxygen and therefore anaerobic conditions. Ferrous sulfide is an insoluble compound and increases the clogging of the soil.

A properly designed and constructed absorption field is a very effective biological and physical filter, which is able to break down the organics and other chemical substances and remove pathogenic organisms, including viruses. This is true, however, only where the soils meet rather specific criteria. Quite often these criteria are not met and failing systems result, causing public health hazards and nuisances.

Unfortunately, many soils in the state do not meet the necessary criteria and thus are unsuitable for on-site liquid waste disposal, while many others are only marginally suitable and may require extensive modification to make them suitable. We are interested in identifying those with minimal or no restrictions and also those soils with marginal suitability that may be successfully modified and safely used for wastewater disposal.

- C. *Problems and Causative Factors in Failure of Subsurface Waste Disposal Systems* - Regardless of the initial permeability of the soil, many absorption fields fail after a number of years of use due to soil clogging. This first type of failure discussed below might be characterized as creeping failure, or death by old age and/or lack of proper maintenance. Failure may be evidenced by the surfacing of untreated effluent causing nuisance odors and public health hazards. Alternatively, subsurface ponding of water in the absorption field may cause the tank to overflow, resulting in sluggishness or stoppage of the drains in the buildings being serviced by the conventional septic tank system. Water then backs up in toilets and other fixtures in the buildings.

The reason for creeping failure is the gradual formation underground of an impermeable clogged or crusted layer in the soil below and around the absorption field. Flow of water through this clogged or crusted zone is severely restricted or even eliminated, although the permeability of the surrounding soil remains essentially unchanged. Consequently, large volumes of septic tank effluent accumulate in the absorption field.

Several physical, chemical and biological phenomena occur, progressively or jointly, to produce zones of gradually decreasing permeability in soils inundated by septic tank effluent. These processes are largely independent of the composition, constitution or texture of the soil at the system site, the design or layout of the absorption field or the nature of the materials and techniques used in its construction. As a result, even the most carefully constructed systems installed in soils of optimum permeability are subject to failure through clogging or crusting. Some of the mechanisms involved in soil clogging by septic tank effluent are described in the following paragraphs.

Every soil is composed of myriads of particles of varying shapes and sizes. Since these particles cannot fit together perfectly to form a solid mass, each soil is replete with a labyrinthic series of interjoining pores of capillaries, which are normally filled to varying proportions with air or water depending upon the moisture content of the soil. Because these capillaries or pores are interconnected, moisture such as that from rainfall can slowly pass from higher to lower layers (horizons) in the soil and eventually into the groundwater. Soils composed mainly of large particles (sands) have larger capillaries and conduct water

faster (i.e., water soaks or percolates through sandy soils at higher rates). As soil particle size decreases, the size of the capillaries also decreases and although the number of capillaries increases, water soaks or percolates much slower through finer grained soils (Rates decrease in the series: coarse sand > fine sand > sandy loam > silt > silt clay > clay).

When large amounts of pure water are allowed to pass through soils composed of particles of different sizes, the rate of percolation is found to gradually decrease. The reason for this is that the flow of water causes smaller particles to become dislodged and to be swept into some of the larger capillaries where they become lodged in constricted areas, effectively blocking the capillaries.

This phenomenon causes deterioration of the physical structure of the soil and when referred to surface soil it is given the name “puddling.” Compression of puddled soils can cause “smearing,” i.e., more effective blockage of the soil capillaries under compression forces. Smearing can occur during construction of on-site sewage management systems if heavy machinery is run over or used to excavate wet soils. This compression effect can cause reduction in flow through the walls of absorption trenches as it effectively seals off soil capillaries.

Puddling and smearing are not the only phenomena that initiate blockage of the soil capillaries. Although most of the solids present in household waste waters (usually about 400 ppm) settle out as sludge at the bottom of the septic tank and the bulk of fats and grease separates as a floating scum at the top of the tank, the effluent discharged at an intermediate height from the tank into the distribution system leading to the absorption field is not completely free of suspended insoluble solids. Residues of vegetable matter and fibers from toilet tissue and similar items form swollen gel-like particles not very different in density from water. Such particles do not settle out rapidly and some are carried in the effluent into the absorption field. Normal septic tank effluent usually contains about 140-150 ppm of suspended solids. The capillaries in the soil of the absorption field filter out these suspended particles very effectively, but the pores of the soil filter become stopped up by them, reducing the rate of percolation.

Effluent from the tank also contains large numbers of bacteria. The bacterial cells also behave like small particles. They are filtered out of the percolating effluent by the soil capillaries, causing further blockage of the soil pores.

Both these bacteria and the natural soil bacteria present in the absorption field are provided with a constant supply of dissolved inorganic and organic nutrients that contained in the effluent flowing into the field. Consequently, all of these bacteria multiply very rapidly in the soil and the resulting microbial biomass creates further barriers to the seepage of water through the soil capillaries.

Although these phenomena cause a detrimental reduction in the rate of flow of water through the soil, they also produce a beneficial increase in the wastewater treatment capability of the soil. A tighter filter is more efficient at removing suspended solids while the larger bacterial biomass is more efficient at degrading organic wastes in the septic tank effluent.

Septic tank effluent enters the absorption field intermittently in direct relation to amount and frequency of water usage. Effluent entering the septic tank displaces a finite volume

of clear liquid into the absorption field. To avoid surfacing of effluent or saturation of the absorption field, soil percolation rate must balance the volume of the effluent to be filtered through the soil layers. As a sequel, air enters the absorption field through soil pores to further dry the absorption field.

As long as air continues to be drawn into the absorption field as the water soaks away, a mixed population of aerobic microorganisms will remain in the absorption field to affect biodegradation of the soluble and insoluble organics transported into the absorption field with the septic tank effluent.

However, as more and more soil capillaries become plugged, the rate at which the water seeps away becomes slower and slower so that less and less air is drawn into the absorption field. Under these conditions, aerobic fermentation in the absorption field is gradually replaced by anaerobic fermentation.

During microbial fermentations, microorganisms digest organic materials using part of them for energy maintenance and part for forming their cellular mass. In order to break down and utilize organic compounds, microorganisms must have other compounds available to be used as electron acceptors. The oxygen present in the air is the normal terminal electron acceptor used by all aerobic organisms in this process. The oxygen is reduced to water and used to produce carbon dioxide (CO<sub>2</sub>) from some organic compounds. If no air is available, microorganisms that can live in the absence of air (anaerobic bacteria) will use other inorganic (e.g., nitrate or sulfate) or organic compounds as electron acceptors. Reduction products associated with organic matter conversion under anaerobic conditions include nitrogen (from nitrate), sulfide (from sulfate) and methane (from organic), each again being accompanied by carbon dioxide (CO<sub>2</sub>) produced from organic matter decomposition.

In absorption fields, when air is no longer drawn into the soil the range of electron acceptors available to microorganisms in the absorption field becomes very restricted. There is no dissolved oxygen in the septic tank effluent because any air in the water has already been used up in fermentations in the tank. Most of the simple, readily biodegradable organic compounds have also been converted in the tank, so that these, too, are no longer available as electron acceptors. Only minor amounts of methane are produced in ponded effluents. The only significant electron acceptor available in ponded fields is sulfate (4-10 ppm). This is rapidly reduced to sulfide. Even though septic tank effluent is alkaline (pH=7.5-8.0), owing to free ammonia in the water, free hydrogen sulfide (odor) becomes detectable in fields that have been constantly ponded for a few months.

Sulfides are toxic to most microorganisms. Only surface bacteria, which can reduce sulfides further to elemental sulfur, can survive in the presence of high sulfide concentrations. The presence of free sulfide in stagnant absorption fields may therefore kill off many of the bacteria, which would otherwise be degrading organics. Some of the free sulfide may be converted to insoluble sulfur, causing further blockage of soil pores. However, very little of the sulfide produced in the absorption field remains in the free state. The bulk of it combines with ions of heavy or transition metals (e.g., iron, manganese, nickel, copper, magnesium, zinc, etc.) present in the soil or in the wastewater (5 ppm total metal cations in septic tank effluent). This causes the deposit of black, insoluble, inorganic sulfides in the beds. Failed absorption fields invariably have intensely black impervious

layers underneath and around the gravel. The gravel itself is generally coated with black slime. This is not surprising since incoming tank effluent already contains 2-5 ppm of sulfide.

The insoluble sulfides contribute to further blockage of the soil capillaries, but this may not be their most deleterious effect. Many elements tied up in insoluble form as sulfides are required by microorganisms for their redox enzymes, the organic catalysts needed for respiratory functions, including degradation of organic matter. Binding of trace elements by sulfides may therefore inhibit organisms otherwise capable of destroying organic materials in the absorption field.

One last contributor to clogging is the action of the anaerobic bacteria themselves. Many microorganisms, especially anaerobic bacteria, produce polysaccharide slimes or gums, which they secrete into their surroundings. These seem to function as a protective sheath around the bacterial cell wall. When formed in situ in the absorption field, such polysaccharides help to form an impermeable layer in the bacterial zone. Organic matter, obtained from clogged layers of ponded fields, contain about 5% polysaccharides, some of which may be from bacterial slimes or gums of this type.

**Appearance of Clogged Zone:** A combination of physical deterioration in soil structure, soil pore blockage by solids and bacteria from the effluent, proliferation of heterotrophic soil bacteria and deposition of insoluble sulfides and bacterial slimes, gums and metabolites (e.g. sulfur) produces a zone of clogging in the soil which will not allow water to seep away at a tolerable rate. Measurement of the distribution of organic matter through typical clogged layers reveals that the bulk of this material occurs in the soil immediately next to the gravel. The amount decreases abruptly with the distance outward or downward from the gravel. A similar distribution is found in the amount of sulfides in the soil.

Where this type of zone occurs in a coarse textured soil, air can begin to penetrate into the soil beneath the clogged areas restoring aerobic conditions when the flow of water diminishes. The minor amounts of organic matter present under the zone of maximum clogging are then apparently oxidized and degraded rapidly, so that the soil in this region reassumes an almost natural appearance. A relatively sharp boundary then results between this aerobic layer and the heavily blocked, black anaerobic layer. The dense anaerobic layer becomes very hard and brittle, assuming the character of a crust in the soil. Occasionally a narrow grey intermediate zone is observed underneath the black crust. This crust is very strong since it is capable of retaining thousands of gallons of stagnant water, which are ponded above it in the field under several feet of hydrostatic head. The soil above the crust is thus permanently saturated with moisture, but that below the crust is unsaturated, generally having about the same moisture content as similar soils at the same depth in areas quite far removed from the field.

- D. *Other Causes of Failure* - Other possible causes of failures with on-site sewage management systems that use soil for final treatment include, but are not limited to:
1. Seasonal or permanent high ground water elevations;
  2. Structural damage to soils with high clay content by construction equipment, especially if soil moisture is high;
  3. System improperly installed;

4. Inadequate design capacity for the actual sewage loading;
5. User abuse in the form of overloading, failure to perform maintenance intervals, neglect of leaking or maladjusted plumbing fixtures, inordinate use of chemical additives or other deleterious material and physical damages to part of the sewage system caused by digging, grading, filling, heavy traffic or other damaging actions;
6. Flooding by storm water or other surface water sources; and
7. Adverse soil conditions such as shallow bedrock or very slowly permeable soil conditions.

### 3) Soil Evaluations

- A. *Use of Soil Maps in Evaluating Site Suitability for Soil Absorption Systems* - Soil maps are an essential part of the environmental evaluation of an area. They represent parts of the earth surface. Soil evaluation for on-site sewage management systems involves a specific location in the landscape that is difficult to describe without a map.

The soil maps indicate different soil types by soil symbols and the solid lines containing the symbol show the boundary and extent of each area. For example, Troup (Tr) represents a deep, well-drained soil, located on upland ridge tops and hillsides of the Southern Coastal Plains; Chatuge (Ch) represents a deep, poorly drained, nearly level soil located on low stream terraces in mountain valleys. Interpretations of the soil maps will indicate whether or not soil at a particular site is subject to an intermittent high groundwater table or has rock formations near the surface. These will also help to avoid mistakes caused by variable percolation test rates that result from the test being conducted during different seasons of the year.

The preliminary investigation of an area with soil maps will permit the determination of site suitability regardless of the time of year the evaluation is made. The soil map is reliable for predicting general soil capabilities for an area of several acres. However, it generally does not contain enough detail to predict the limitations for a specific disposal site because different types of soil can exist within short distances. Maps are likely to be least reliable in the vicinity of a soil boundary.

The preliminary investigation of an area with the use of soil maps can be an important tool in reducing development costs. If the soil map indicates that a high percentage of an area is unsuitable for conventional septic tank/soil absorption systems, it may not be economically feasible to pursue development. This would require consideration of alternative on-site sewage management systems or a community or public sewage treatment system. If a community or public sewage treatment system is selected, then a lot by lot evaluation could be eliminated.

A subdivision map or plat showing lots and roads is of little value for evaluating an area for the development of conventional septic tank/soil absorption systems unless soil types have been used as a basis for the evaluation. In fact, without consideration of soil types during the preliminary investigation, this could create problems such as road and street relocation, resubdividing and other costly changes.

- B. *Physiographic Provinces* - The physiographic provinces or major land resources areas

(MLRA's) provide a general idea of what can be expected in terms of soil conditions and parent materials. Georgia has eight provinces that vary greatly from the mountains to the sea. See Figure 2.C.

- *Sand Mountain (MLRA 129)* - This province consists of mountain plateaus with gently sloping ridge crests at elevations of approximately 1500 to 2000 feet above sea level. Side slopes of the plateaus are steep with escarpments of sandstone, shale and limestone. Mean annual rainfall is approximately 54 inches.
- *Southern Appalachian Ridges and Valleys (MLRA 128)* - This province consists of ridges of limestone, cherty limestone, sandstone and gently sloping valleys filled with material eroded from the ridges. Elevations range from approximately 600 to 1500 feet above sea level. Mean annual rainfall is between 52 and 56 inches.
- *Southern Blue Ridge (MLRA 130B)* - The Blue Ridge Province consists of mountain ridges with steep slopes, foothills and narrow intervening valleys, underlain by acid crystalline metamorphic rock. Depth to rock is shallow except over some of the colluvial materials occurring near the bottom of slopes. Elevations range from about 700 to 4,700 feet above sea level. Mean annual rainfall is between 52 and 90 inches.
- *Southern Piedmont (MLRA 136)* - This province is a broad plain that has been dissected by streams. It is an old land surface with rounded slopes that is underlain by acid crystalline and metamorphic rock. Elevations range from about 500 to 1500 feet above sea level. Mean annual rainfall is 44 to 56 inches. The degree of the slope has a strong influence on the soils developed over a given parent material. On steep relief, the soils are generally shallow and weakly developed, while on flat relief the soils are usually deeply weathered with deep clay subsoils. Clay or fragipans are frequently associated with flat areas and seasonal water tables are associated with these soils.
- *Sand Hills (MLRA 137)* - This province consists of gently sloping to steep sloping soils derived from marine sands, loams and clays that were deposited on acid crystalline and metamorphic rocks. Elevations range from 300 to 500 feet above sea level. Mean annual rainfall is between 40 and 52 inches.
- *Black Lands (MLRA 135A)* - This province consists of irregular out-croppings of marl and clays and shallow to moderately deep soils derived from marl and clay. Elevation is approximately 400 feet above sea level. Mean annual rainfall is about 46 inches.
- *Southern Coastal Plain (MLRA 133A)* - This province consists of soils occupying broad in stream areas having gentle to moderate slopes and underlain by marine sands, loams and/or clays. Elevations range from approximately 250 to 500 feet above sea level. Soils are generally deep and depth to rock is usually greater than six feet. Mean annual rainfall is between 40 and 52 inches.
- *Atlantic Coast Flatwoods (MLRA 153)* - This province consists of nearly level and shallow depression soils, which generally have seasonal high water tables and are underlain by marine sands, loams and/or clays. Deep sandy surface soils are usually found in this province, but loams and clays underlie most of the area and restrict downward movement of water. Seasonal water tables and drainage are a problem. Elevations range from sea level to about 300 feet above sea level. Mean annual rainfall ranges between 44 and 53 inches.

- *Tidewater Area (MLRA 153B)* – This province is on a nearly level coastal plain crossed by many broad, shallow valleys that have meandering stream channels. Most of these valleys terminate in estuaries along the coast. Mostly unconsolidated Coastal Plain sediments occur at the surface throughout this area. They are a mixture of river-laid sediments in old riverbeds and on terraces, flood plains and deltas. The soils in the area are characterized by restricted drainage; an aquic moisture regime; and mixed clay and siliceous mineralogy. The water table typically is close to the surface. Elevation ranges from sea level to less than 25 feet. Local relief is mainly about 3 feet or less. Average annual precipitation in this area is 40 to 58 inches.

C. *Soil Profile* - A soil profile consists of a vertical section of the soil extending through all its horizons and into the parent material. A number of similar soil borings indicate a soil series landscape. A soil profile will have a surface soil, a subsoil and parent material. Upland soils, other than in the coastal plains, usually have hard rock below the parent material.

Soil borings are made in a unit of landscape to confirm expectations. A record should be kept of the depth, color, and texture of each major horizon. The record should show the range in depth, color and texture within a unit of landscape. Several borings may be necessary where deviations are noted.

Soils on hilly or steep topography can frequently be expected to have thin or no subsoils. In some places, the original surface has eroded away and the present surface layer contains subsoil material.

Changes in the soil series may be due to changes in parent material, deposits or capping, and depth to restrictive layers such as clay, sand, fragipans or hard rock.

The soil borings will indicate depth to hard rock. The soil color, especially subsoil color, will indicate the presence of a seasonal water table in the soil, which causes problems during wet weather. The soil texture will indicate possible problems with the rate of absorption, as well as the best horizon to test for absorption rates and in which to install absorption lines.

D. *Soil Color* - Soil color is a reliable guide to the natural drainage of a landscape. It can provide clues as to whether the soil has difficulty absorbing the normal rainfall or can absorb the rainfall without ponding at some point in the soil profile.

Soil color is directly related to the oxidation or reduction of the iron present in most soils. The organic acids passing through the soil require the addition of oxygen from their decomposition to carbon dioxide and water. When soil pores remain filled with water for extended periods, the oxygen supply is restricted and the iron is reduced to help supply the needed oxygen. This produces gray, brown or red mottles or gray matrix color.

The significance of this to the proper function of an absorption field is that colloidal organic matter moves into the absorption field and, if not oxidized, tends to block the soil pores. In addition, unaerated sewage effluent then travels into the ground water for reuse in a very poor quality condition.

Uniform red, brown or yellow soil color does not insure the proper function of an absorption field. It does indicate that the soil is able to absorb the normal rainfall without

ponding, but soils with bright colors (red, brown, yellow) may have slow rates of absorption and, consequently, not be capable of absorbing the additional burden of sewage effluent.

**Red or Brown** - Red or brown colors indicate good natural drainage in relation to rainfall. Soils with these colors occur on upland ridges or side slopes and allow good runoff of rainfall. Many soils that are red or brown in color may have slow rates of absorption.

**Gray** - Gray colors indicate a ponding of water in any horizon in which they occur. Soils with gray colors occur on flat or slightly depressed low lands and most of the rainfall soaks into these soils. The ponding of water is generally seasonal in nature and usually will not be present in dry periods. It can occur in sands or clays and may not be directly related to percolation tests. Gray color may also occur in the lower subsoil or at the horizon of some soils on steep slopes and should not be interpreted as a sign of wetness in these instances.

**Black** - Black colors are due to organic matter that masks the true color of the soil. Organic matter accumulates because the soils remain wet most of the time, which prevents its breakdown. Soils with this color exist in shallow depressions or bays.

**Gray and Yellow Mottling** - Gray and yellow mottling indicates a seasonal ponding of water in the soil at the depth at which the mottling occurs. Absorption lines shall not be placed at depths where the mottling is observed because they can be expected to fill with ground water during wet periods. To be reliable, moist soil from the subsoil of the profile should be observed for color. In most cases, there is a direct relationship between soil color and landscape positions.

Water may pond in soils for very short periods above the levels indicated by gray mottles. The gray color indicates the water ponds for an extended period. Even a mottle-free soil may be saturated for short periods after a rain.

**Gray Color in Soil** - The gray color or gray mottles are usually associated with ponded water in the soil profile. It is related to the reduction of the iron in the soil from the ferric to the ferrous form. Reduction of iron occurs when organic acids are present in a saturated soil with limited oxygen. The organic acids are unable to secure enough oxygen from the water and revert to the next most readily available supply from the ferric iron. Gray mottles or colors indicate the supply of oxygen is limited during wetter portions of the year. A higher percentage of gray in a soil indicates longer duration and greater frequency of the ponding periods.

Soils with gray colors or mottles indicate potential problems with absorption systems. Periods of soil saturation will interfere with the disposal of water into the soil. Soils with a wetness problem have a low oxygen supply during saturated periods and the addition of effluent compounds the problem, causing more rapid clogging of soil pores with organic waste.

Gray colors or mottles indicate about four weeks of saturation on a repeating basis throughout the year. The cause of the saturation of the soil may be due to slow percolation in the gray mottled zone or to a restriction at some depth below the horizon which ponds water into the mottled horizon.

Absorption fields installed in mottled horizons of soil will have difficulty absorbing sewage effluent and organic waste during the periods of saturation. Saturation of the absorption field will eliminate the safety factor provided by the gravel trench storage area and overload the system. Repeated saturation of absorption fields with excess ground water causes blocking of the soil pores with colloidal organic matter due to low oxygen supply. Unsaturated conditions are necessary at both the absorption field depth as well as below the absorption field for a reasonable distance to insure adequate filtration and treatment of sewage effluent.

- E. *Natural Soil Drainage* - The natural drainage of soil depends on how much of the water falling on the soil enters the soil and how well it passes through the soil. The position of the soil on the landscape and the degree of slope influence the former and affect the drainage class of the soil.

Flat land or depression areas have very little runoff and may receive additional runoff from higher ground, most of which must drain through the soil. Poorly drained soils generally occur in these positions. Undulating or rolling land has more runoff and less water must pass through the soil. Soils in these positions are generally well drained or moderately well drained. On steep slopes, most of the water runs off. The amount and types of vegetation also influence the amount of runoff.

The texture of the soil is another factor that influences the natural drainage. Sandy soils drain better than clay soils. A well-drained clay soil may still not be absorbent enough to pass a percolation test. Whether the subsoil is heavy (clay) or light-textured (sandy) may influence the natural soil drainage.

Fragipans and solid rock influence the natural drainage because they restrict the downward movement of water. If the internal drainage is limited, then the capacity of the soil to absorb water is limited and water will stand in the soil above the restriction.

The presence of water above the restriction is reflected in the color of the soil. The colors and where they occur in the soil are used in determining the drainage class of the soil. The drainage classes do not refer to specific depths at which the mottling occurs but rather to the horizons in which mottling occurs. The depth to gray mottles will affect classification of the soil.

The question might be raised as to how the soil could be excessively drained. The excessively drained class is a reflection of the availability of water to plants rather than of drainage as such. It reflects drainage in that these soils do not hold enough moisture for normal plant growth. However, soils that are excessively drained may be undesirable for the installation of on-site sewage management systems due to the fact that the effluent may pass through the soil too rapidly to be properly filtered and thus reaches the groundwater before it has been adequately treated.

The drainage classes are as follows:

1. *Poorly Drained Soils* - Poorly drained soils can generally be expected on broad flats or depression areas along drainage ways. Runoff water moves very slowly and the soil remains saturated for long periods. Frequently, these soils receive additional runoff water from higher surrounding areas. The seasonal water table is at or near the soil surface for long periods. The surface and subsoil colors are grays with a few yellow

- and reddish mottles. Frequently the subsoils are clay, but poorly drained soils may also be sandy. Percolation tests are not needed on these soils because a seasonal water table will restrict their use. Some of these soils may pass a percolation test during dry periods.
2. *Somewhat Poorly Drained Soils* - Somewhat poorly drained soils occur on flat to gently sloping relief and most of these areas are subject to flooding. Water drains from the surface soil but not from the subsoil. They are commonly mottled with gray at depths of six (6) to twenty (20) inches from the soil surface. They have a seasonal water table in the lower surface or upper subsoil. The entire soil generally has a yellowish or leached appearance, indicative of internal drainage problems. The percolation tests, if done in such soils, must be conducted above the seasonal water table elevation and be properly saturated prior to running the tests.
  3. *Moderately Well-Drained Soils* - Moderately well drained soils occur on nearly level to strongly sloping topography. These soils have gray mottling in the lower subsoil (below 20 inches), indicating a restriction to drainage below this depth. Soils with restrictive layers, such as fragipans, may have this drainage classification but it is not restricted to soils with fragipans. These soils generally have rather pale surface colors but may have red, brown or yellow colors in the upper subsoil. Percolation tests on these soils will mainly measure lateral movement of water because movement is restricted in the lower subsoil. Deeper percolation tests may be necessary to determine the degree of restriction to internal drainage.
  4. *Well-Drained Soils* - Well-drained soils occur on nearly level to steep relief. They are free of internal restrictions in natural drainage. The soils may be red, brown or yellow in the subsoil. In some places, yellow and red mottling may occur in the lower subsoil. These soils may need to have percolation tests run because some well drained soils are too heavily textured (clayey) to absorb water at the necessary rates.
  5. *Excessively Drained Soils* - Excessively drained soils generally have little or no subsoil development and do not retain much water. Most of these soils are sandy. Many of these soils are shallow to rock north of the fall line. Contamination of shallow ground water aquifers is a concern where these soils are being considered for the installation of on-site sewage management systems using soil absorption for disposal of effluent.
- F. *Soil Texture* - Soil texture depends upon the relative proportions of sand, silt and clay particles in a soil. These proportions can be determined by special equipment in a laboratory. Relative differences in soil textures can be determined in the field by feeling the soil when moist. It is of value to determine if a soil is predominantly sand, clay or silt or is a mixture of various sizes. Within a geographic region, infiltration rate, permeability, aeration and drainage are closely related to soil texture. The evaluation of texture is needed to provide some indication of the rate of absorption and problems with absorption. Sandy horizons will have larger pores than clayey soils. Thus, a clay soil can be blocked by organic matter in the drainfield more readily and fail more rapidly. The essential part of texture evaluation is to determine if a soil is sandy or loamy or contains enough clay to produce a ribbon when moist.
- G. *Seasonal Water Tables and Free Water in Soils* - Attempting to determine seasonal water tables by the free water present in a soil at any point in time can create problems with uniformity of evaluation. The problem is one of consistency of evaluation both in wet and

dry periods. Therefore, the evidence of gray colors or gray mottling is the best indicator to determine if soils are saturated or have seasonal water tables. Free water may occur above the depth of gray colors or mottling in wet periods and be absent in dry periods. Thus, a reliable evaluation of seasonal water tables must include gray colors. Generally, the presence of Chroma 2 gray color in the soil horizon is an indication of the seasonal high water table.

Free water moves through the larger soil pores after a rain. The distance that the free water moves downward depends on the intensity and duration of rain, the surface absorption capacity of the soil, changes in pore size with soil texture, depth to restrictive layer and the amount of free water already in the soil. Free water will pond on top of a soil or near the surface causing seasonal water tables that usually can be observed during late winter or spring. Care must be exercised in using the presence of free water to indicate a seasonal water table. A well-drained sand may have free water moving through the profile for a day or two following a heavy rain. Therefore, free water present in the soil shall be associated with gray colors in the form of mottles or base color of the soil to provide consistency in indicating seasonal water tables. When free water is present in the absence of gray soil colors, this could indicate a slow rate of absorption.

Seasonal water tables are the result of restrictions in free water movement. The restrictions can be clay horizons, plinthite horizons, dense sandy horizons, parent material, fragipans and rock. Oxidation of organic waste is greatly reduced in the presence of free water. Since one of the objectives of an absorption field is the oxidation of organic matter, the accumulation of this waste creates problems. The soil pores are clogged with biomass from the growth of microorganisms. Health hazards may result if a seasonally high water table forces the sewage effluent in an absorption field to surface, causes effluent to back up into a dwelling or commercial establishment or allows the effluent to enter and contaminate ground water.

- H. *Degree and Type of Slope* - Soil information and soil type have a definite relationship with relief and landscape features. Major changes in slope usually indicate changes in soil characteristics. Landscapes can be mentally divided into slope units for evaluation. Not only the degree of slope, but also the type of slope should be observed. A convex slope has a mounded shape and is shallow to parent material. A concave slope is bowl-shaped and because of the slow movement of runoff water, there is a corresponding increase in the amount of water moving through the soil, which weathers the parent material and forms a deeper soil. The type of slope commonly changes from one side of a drainage way to the other. Examples may include:
1. *Flat Topography* - Flat topography receives the maximum impact of climate in the form of rainfall. Slopes are less than 2 percent. Runoff, if it occurs, is very slow and ponding is common for long periods. The rain has time to enter the soil, resulting in more intense and deeper weathering, which causes downward movement of clay and thick sandy surfaces. Internal drainage problems and seasonal water tables are expected on flat landscapes.
  2. *Gently Sloping Topography* - Gently sloping topography appears flat but actually has a slight convex curve to the surface. Slopes range from two to six percent. This allows for a portion of the rainfall to run off before entering the soil. The soils on this type of

- topography are generally weathered and deeply developed but can be expected to be better drained than those on flat topography.
3. *Sloping Topography* - Sloping topography includes those with slopes in the range of six to fifteen percent. Runoff is increased and the soils are generally shallower to parent material. High clay content layers are common between 15 and 36 inches from the surface. Natural waterways are a problem in subdivisions, and lot adjustment may be necessary to avoid drainage ways. Erosion of surface soils can be a major problem in subdivisions due to increased slopes with this type of topography.
  4. *Concave Relief* - Concave relief describes areas of depression. These areas receive large amounts of water and tend to be very wet. Generally, they are not acceptable for construction of absorption fields.
- I. *Position in Landscape* - The position of an area of land in the landscape, like the physiographic province, gives some idea of what to expect in terms of soils. The position may be apparent from observation or it may become apparent as soil borings are made. Examples may include:
1. *Alluvial Position / Bottom Land / Floodplain* - Alluvial positions are the areas adjacent to streams or rivers where flooding may occur. They differ slightly from colluvial positions in that the soil material has been picked up by floodwaters, sorted by stream flow and deposited. Sandy materials are deposited adjacent to the stream channel and clays are deposited in the slack water adjacent to the valley walls. The alluvial soils are formed by deposition in layers rather than by weathering of parent material. The soil horizons are not distinct and may be nothing more than textural changes. The position in the landscape is characteristic in that it is a flat area adjacent to the stream, with the soil having poor definition in terms of surface soil and subsoil horizons. The soils may range from excessively drained to poorly drained. Rates of absorption are not a problem in dry weather in the better drained alluvial soils. The major hazards are periods of flooding and the complete saturation of the soil that occurs during these times.
  2. *Colluvial Positions (Local Alluvial)* - Colluvial positions are the areas along drainage ways that periodically flood during and after a rain. Runoff water from the upland carries small rocks and soil material down the slopes and part of this is deposited at the base of the slope with little sorting. The result is a filling of the area with partially sorted soil material and the development of a deep surface horizon. The soil in such a position may range from excessively drained sand to poorly drained clay. The problem with colluvial areas is the periodic flooding of the soil during and after a rain, the seepage from adjacent uplands that keeps the soil moist and the natural accumulation of organic matter. Flooding does not always remain long enough in some places to reduce the soil and produce a gray color. The incidence of failure of absorption fields is related to the accumulation of organic matter. Over a period of time, the absorption field fails as the organic matter accumulates in the field and blocks lateral movement of water. Detailed topographic maps provide a good means of locating drainage ways in the landscape. Observing the landscape before making soil borings may indicate the site to be the lowest point and thus the channel of runoff water. The soil borings may indicate a deep uniform surface soil not expected in upland soils. Rates of absorption may be good in such positions in dry weather.

3. *Old Colluvial* - Old colluvial deposits are formed from materials that have moved down-slope by gravity and water. The material has not been sorted and may contain angular and partially rounded rocks of all sizes. These deposits are generally associated with mountainous areas but may occur at a considerable distance from their source. The distinguishing features are a uniform slope gradient at the base of the mountain and the loose rock throughout the profile. The depth of thickness of the deposit is variable. The natural drainage ranges from well drained to poorly drained. The area of contact with the old land surface frequently forms a tight layer, resistant to water movement, which may be reflected in the natural drainage of the soil. Local deposits of material occur on mountain slopes and throughout the Piedmont and Valley provinces. The soil problems are similar to those of upland soil except that a tight layer can be expected at the point of contact with the old land surface, which may limit absorption. Stability of the material may be a problem when it is cut for roads or house sites. Weathering of underlying rocks is generally deeper than that of adjacent areas without colluvial depositions.
4. *Terrace Positions* - The terrace positions are the old alluvial positions that have been left by the down cutting of streams. The result is that only the low terrace positions may flood under normal rainfall. The terrace positions are generally underlain by gravel depositions. The topography is characterized by the almost flat relief and the location adjacent to streams but at a higher elevation. The soils range from well drained to poorly drained, with the better drained soils adjacent to the stream and more poorly drained soils adjacent to the valley walls. The soils have developed surface and subsoil horizons similar to upland soils. They are frequently underlain by rounded gravel depositions. The problems of these soils are similar to those of the upland soils. The gravel deposits may be loose or compact and dense. Many soils in this position have fragipans. The lower terraces are subject to flooding.
5. *Upland Positions* - This term includes all areas not covered by other positions. The soils developed in these positions result from the soil-forming factors working on parent material. The natural drainage may range from excessively drained to very poorly drained and is not related to elevation. The upland soils are strongly influenced by and reflect the type of parent material from which they were formed and are also influenced by the degree of slope.

#### **4) Soil Investigations**

##### *A. Soil Investigation Requirements:*

1. Subdivisions:
  - a. *Pre-Development Review* - It is recommended that developers considering subdivision or mobile home park development obtain at least a preliminary soil study from a Certified Soil Classifier, Registered Engineer or Registered Geologist prior to developmental improvements.
  - b. *Final Review* - A soil map and soil descriptions based on a high intensity soil study are required for subdivisions and mobile home parks prior to approval of such development by the county health authority. The soil map shall be overlaid onto a

copy of the final subdivision plat and the approved professional (Certified Soil Classifier, Registered Engineer or Registered Geologist) must affix their signature and seal on the final plat.

- c. *Minimum Requirements for a High Intensity Soil Study (Level 3)* - A high intensity soil study shall be identified as a Level 3 soil survey and map. A Level 3 soil survey and/or soil map are based on a comprehensive soils investigation of a given landscape. The purpose of the soil survey is to identify, delineate and interpret the suitability of the soil series found on the site as it pertains to use for on-site sewage management systems. The soil survey must meet or exceed specified accuracy and quality standards for the data from which the County Board of Health permits on-site sewage management systems. All Level 3 soil surveys and related interpretive data shall be based on the Georgia Department of Public Health Manual for On-Site Sewage Management Systems, National Cooperative Soil Survey standards and the current Soil Survey Manual (Soil Survey Staff, 1993). Soil series used to name map units must be classified according to the most recent edition of Soil Taxonomy (Soil Survey Staff, 1999), with map unit boundaries and map features plotted on a map at a scale that may range from one inch equals ten feet (1"=10') to one inch equals one hundred feet (1"=100'). Smaller map scales (1"=200', 1"=500', etc.) are not acceptable. Level 3 soil surveys must be based on a two-foot contour interval topographic map. The topographic map and boundary survey must be provided before the beginning of any fieldwork. The soil survey must include a title block or caption that includes the project and/or client name, location of the project, date of the survey, narrative, bar scale and north arrow. The soil survey shall include any features that may affect the location or performance of on-site sewage management systems. Examples are: the location of springs, wells, existing structures, rock outcrops, ephemeral drains, gullies and visible trash pits. The soil survey must include a legend that defines any symbols used to illustrate these features on the soil map. The soil survey and soil map must bear the name, stamp, address and telephone number of the Certified Soil Classifier, Registered Engineer or Registered Geologist performing the survey. The "Official" Level 3 soil survey used for on-site sewage management system permitting is that which bears the original seal and signature of the individual performing the work. The Certified Soil Classifier, Registered Engineer or Registered Geologist shall affix their signature and seal only on soil surveys that are their work or work performed under their direct supervision. Any revision to a Level 3 soil survey must be clearly designated as such and dated. The Level 3 soil survey must include a table or narrative that describes site-specific properties of each map unit (named for soil series) mapped at the site. For each map unit, the table or narrative must include the following: soil series name (symbols are not allowed), the percent slope or slope range (symbols are not allowed), minimum depth (range is unnecessary) to seasonal saturation (seasonal high water table), minimum depth (range is unnecessary) to auger refusal or impervious layer (soft or hard bedrock or other horizons that restrict water movement), recommended installation depth (if applicable) and estimated percolation rate at the recommended installation depth (if applicable). The estimated percolation rate shall be based on the most limiting soil horizon that comes into contact with the absorption trench sidewall, bottom and for a distance

one (1') foot below the recommended installation depth. The upper and lower depth limits of the horizon in which installation is recommended shall be provided for each map unit. The depth range over which installation is recommended must be at least 24 inches to encompass a 12-inch sidewall thickness and 12 inches of soil below the trench bottom. If the 24-inch thickness installation zone includes a horizon with lower percolation rate than the optimum, the maximum percolation rate in the depth interval must be used for on-site system design. Minimum depths to bedrock or seasonal saturation shall be provided for each map unit and specific depths identified for each boring on the soil map. Phases of soil series are an acceptable method to map depths more narrow than those used to define the series. Variants of series have different interpretations than the named series and these differences shall be reflected in the interpretive table. An interpretive statement describing the limitations for utilization of on-site sewage management systems shall be provided for each soil series map unit. This interpretive statement may contain notes, observations or other pertinent information reflecting the soil properties of the map unit that affect its ability to function for wastewater disposal. These map unit interpretation statements must be based on the soil properties and landscape positions observed on site by the approved professional. Map unit interpretive statements shall be expressed in a narrative format on the soil survey report or soil map. The number of soil observations required for the Level 3 soil survey will depend on the soil conditions encountered during the study and landscape complexity at the site. At least four (4) pedons shall be evaluated and classified for each one (1) acre mapped. For example, if an area is 1.5 acres, a minimum of 6 test borings must be evaluated and classified. If the site is less than one acre, a minimum of four (4) pedons shall be evaluated and classified. However, the Soil Classifier, Registered Engineer or Registered Geologist shall perform as many soil boring observations as necessary to ensure the named soil series or a soil series with similar or more favorable properties are verifiable onsite. All soil observations must be numbered and flagged on site and their location illustrated with a symbol and corresponding boring number on the finished soil map. All permanent and reproducible ground control points utilized to locate soil observations will be shown on the finished soil map so these observation points can be reestablished at a later date. All soil maps must contain a statement describing the method and/or instruments used to locate each soil observation from control points. Boundaries between map units are commonly gradual instead of abrupt as implied by a line drawn on a map. In addition, the boundary between map units may be difficult to locate exactly unless definitive landscape features are present or closely spaced soil observations are made to locate the boundary. To ensure that on-site sewage systems are not installed in soils unsuitable for their use, soil delineation lines between suitable soils, limited suitable soils and unsuitable soils shall be accurate to within 20 feet of the delineated soil boundary. If through additional closely spaced soil observations the site evaluator can document the area within 20 feet of the boundary has soils suitable for an on-site sewage system (conventional or alternative), the system may be installed closer than 20 feet from the suitable-limited suitable-unsuitable boundary. The location of all observations used to determine near boundary soil suitability must be shown on the final soil

map and characteristics observed must be summarized in the site report. All soil observations shall be a minimum depth of 72 inches unless a refusal layer, including seasonal saturation horizon, is identified. If the lower limit of the recommended installation depth is greater than 48 inches, the soil observation must be extended to not less than 24 inches beneath this lower limit. Backhoe pits may be substituted for observations from auger borings. Mechanical augers, which disturb soil structure, shall not be used. The Soil Classifier, Registered Engineer or Registered Geologist must keep field notes for each soil observation that include: boring number, soil series name, percent slope, depth and type of restrictive horizons present and morphological properties of major subsoil horizons (upper and lower depth, texture, matrix and redoximorphic feature color [Munsell notation]). All surveys and related interpretive data shall meet National Conservation soil survey (NCSS) and United States Department of Agriculture (USDA) Soil Survey Manual standards for map purity. Map units will not have more than 15 percent inclusions of soils with different interpretation for on-site sewage management systems from the named series.

- d. *Minimum Requirements for Special Soil Investigations (Level 4)* - A special soil study shall be identified as a Level 4 soil survey. The County Board of Health may require special soil studies when alternative on-site sewage management systems are proposed and additional soil data are needed to adequately address site suitability and/or system design. The County Environmental Health Specialist should be consulted prior to the initiation of the special investigation. The special investigation will typically be made for a specific location within an individual lot or parcel in the area proposed for the installation of an on-site sewage management system. Special investigations may include measurement of percolation rate for specific horizons, excavations to determine bedrock hardness and continuity, monitoring seasonal groundwater tables or other similar data that may be needed to aid in the interpretation of soil suitability and the protection of ground and surface water. Finished soil reports will have clear and obvious designations as to information that is Level 3 and/or Level 4. A Level 4 soil survey expands on the existing Level 3 soil survey in thoroughness and/or detail. Results of the Level 4 soil investigation should be presented in a format similar to that of the Level 3 soil investigation, including a map with more detailed soil delineations and/or location of measurements, an interpretive table and, if needed, narrative statements describing methods and results that impact suitability for an on-site sewage management system. The Level 4 soil survey shall meet all minimum requirements of the Level 3 soil survey, with the exception that test boring sites from the previous Level 3 investigation may be used for the Level 4 investigation. There is no minimum number of pedon observations required for a Level 4. At a Level 4 intensity, individual soil series are expected to be mapped and delineated with such a degree of accuracy that, at any location chosen to investigate within a given map unit, the named soil series or one with similar or more favorable properties for the installation of an on-site wastewater management system must be verifiable. The name, official seal and signature of the Certified Soil Classifier, Registered Engineer or Registered Geologist performing the investigation must be on the report.

- 
2. Soil Data Acceptability for Individual Lots:
    - a. Soil evaluations on individual lots shall be performed by the following individuals:
      - (1) A Certified Soil Classifier, Registered Engineer or Registered Geologist if a Level 3 soil survey is required.
      - (2) With the approval of the County Board of Health, an Environmental Health Specialist I or higher, District Environmental Health Director, DPH Environmental Health Program Director, meeting the following requirements, may conduct soil investigations for individual lots for single family residences:
        - i. A Level II Inspector Certification; *and*
        - ii. Successfully passes a field examination demonstrating the ability to identify soil texture and expected percolation rate, identify redoximorphic features and identify restricted or impervious soil horizons.
    - b. Individuals who are approved by the County Board of Health that perform soil evaluations on individual lots for single family residences shall follow the following protocols:
      - (1) A minimum of three soil borings shall be dug in the proposed location of the on-site sewage management system absorption field and duplicate absorption field area;
      - (2) All borings shall be dug to a minimum depth of 72 inches unless a refusal layer is identified or to not less than 24 inches beneath the planned absorption trench bottom installation depth.
      - (3) A soil report shall be made containing:
        - i. A sketch identifying boring locations; and
        - ii. A table identifying boring number, expected percolation rate and depth at which it occurs, the depth of seasonal high water table and depth of any refusal layer; and
        - iii. Sites with poor percolation, redoximorphic features or impervious soil horizons within 24 inches of the planned absorption trench bottom, a seasonal high water table within 30 inches of the original ground surface or any other questionable soil features will be referred to a Certified Soil Classifier, Registered Engineer or Registered Geologist for evaluation.
  3. Evaluation of soil for use as fill material
    - a. Evaluation of soil for use as fill material on individual lots may be performed by the following individuals:
      - (1) A Certified Soil Classifier, Registered Engineer or Registered Geologist
      - (2) With approval of the County Board of Health, a Level II Certified Environmental Health Specialist I or higher, who has successfully completed

training and demonstrated proficiency in soil fill evaluation may approve soil for fill material.

- b. Individuals approved by the County Board of Health to perform soil evaluations of fill material shall follow the following protocols:
  - (1) A minimum of four (4) borings shall be dug within the in-place fill material.
  - (2) All borings shall be dug to a minimum depth twelve (12) inches below the original soil surface.
  - (3) A fill site evaluation form shall be completed:
    - i. Evidence that the vegetative topsoil has been removed and fill area properly tilled.
    - ii. The soil fill is examined for texture and fines; percolation rate estimated.
    - iii. The size of the filled area identified and filled area properly sloped.

## 5) Glossary of Soil Terms

**Aeration (soil).** The exchange of air in soil with air from the atmosphere. The air in a well aerated soil is similar to that in the atmosphere; the air in a poorly aerated soil is considerably higher in carbon dioxide and lower in oxygen.

**Aggregate (soil).** Many fine particles held in a single mass or cluster. Natural soils aggregate, such as granules, blocks or prisms, are called peds. Clods are aggregates produced by tillage or logging.

**Alluvium.** Material, such as sand, silt or clay, deposited on land by streams.

**Bottom land.** The normal flood plain of a stream, subject to flooding.

**Clay.** As a soil separate, mineral soil particles less than 0.002 millimeter in diameter. As a soil textural class, soil material that is 40 percent or more clay, less than 45 percent sand and less than 40 percent silt.

**Colluvium.** Soil material, rock fragments or both moved by creep, slide or local wash and deposited at the base of steep slopes.

**Depth to rock.** Bedrock is to near the surface for the specified use.

**Dissimilar Soil.** Soil that is different from the named soil series in both properties and major interpretations.

**Drainage class (natural).** Refers to the frequency and duration of periods of saturation or partial saturation during soil formation, as opposed to altered drainage, which is commonly the result of artificial drainage or irrigation but may be caused by the sudden deepening of channels or the blocking of drainage outlets. Seven classes of natural soil drainage are recognized:

*Excessively drained.* Water is removed from the soil very rapidly. Excessively drained soils are commonly very coarse textured, rocky or shallows. Some are steep. All are free of the mottling related to wetness.

*Somewhat excessively drained.* Water is removed from the soil rapidly. Many somewhat excessively drained soils are sandy and rapidly pervious. Some are shallow. Some are so steep

that much of the water they receive is lost as runoff. All are free of the mottling related to wetness.

*Well-drained.* Water is removed from the soil readily but not rapidly. It is available to plants throughout most of the growing season and wetness does not inhibit growth of roots for significant periods during most growing seasons. Well drained soils are commonly medium textured. They are mainly free of mottling.

*Moderately well-drained.* Water is removed from the soil somewhat slowly during some periods. Moderately well drained soils are wet for only a short time during the growing season, but periodically they are wet long enough that most mesophytic crops are affected. They commonly have a slowly pervious layer within or directly below the solum or periodically receive high rainfall or both.

*Somewhat poorly drained.* Water is removed slowly enough that the soil is wet for significant periods during the growing season. Wetness markedly restricts the growth of mesophytic crops unless artificial drainage is provided. Somewhat poorly drained soils commonly have a slowly pervious layer, a high water table, additional water from seepage, nearly continuous rainfall or a combination of these.

*Poorly drained.* Water is removed so slowly that the soil is saturated periodically during the growing season or remains wet for long periods. Free water is commonly at or near the surface for long enough during the growing season that most mesophytic crops cannot be grown unless the soil is artificially drained. The soil is not continuously saturated in layers directly below plow depth. Poor drainage results from a high water table, a slowly pervious layer within the profile, seepage, nearly continuous rainfall or a combination of these.

*Very poorly drained.* Water is removed from the soil so slowly that free water remains at or on the surface during most of the growing season. Unless the soil is artificially drained, most mesophytic crops cannot be grown. Very poorly drained soils are commonly level or depressed and are frequently ponded. Yet, where rainfall is high and nearly continuous, they can have moderate or high slope gradients.

**Flood plain.** A generally flat plain or depression susceptible to being flooded from any source, including small and intermittent watercourses and coastal areas subject to intermittent tidal action.

**Fragipan.** A loamy, brittle subsurface horizon low in porosity and content of organic matter and low or moderate in clay but high in silt or very fine sand. A fragipan appears cemented and restricts roots. When dry, it is hard or very hard and has a higher bulk density than the horizon or horizons above. When moist, it tends to rupture suddenly under pressure rather than to deform slowly.

**Hardpan.** A hardened or cemented soil horizon or layer. The soil material is sandy, loamy or clayey and is cemented by iron oxide, silica, calcium carbonate or another substance.

**Horizon (soil).** A layer of soil, approximately parallel to the surface, having distinct characteristics produced by soil-forming processes. In the identification of soil horizons, an upper case letter represents the major horizons. Numbers or lower case letters that follow represent subdivisions of the major horizons. An exploration of the subdivisions is given in the Soil Survey Manual. The major horizons of mineral soil are as follows:

*O horizon.* An organic layer of fresh and decaying plant residue at the surface of a mineral soil.

*A horizon.* The mineral horizon at or near the surface in which an accumulation of humified organic matter is mixed with the mineral material. Also, a plowed surface horizon, most of which was originally part of a B horizon.

*E horizon.* The mineral horizon in which the main feature is loss of silicate clay, iron, aluminum or some combination of these.

*B horizon.* The mineral horizon below an O, A or E horizon. The B horizon is in part a layer of transition from the overlying horizon to the underlying C horizon. The B horizon also has distinctive characteristics such as: (1) accumulation of clay, sesquioxides, humus or a combination of these; (2) prismatic or blocky structure; (3) redder or browner colors than those in the A horizon; or (4) a combination of these. The combined A and B horizons are generally called the solum or true soil. If a soil does not have a B horizon, the A horizon alone is the solum.

*C horizon.* The mineral horizon or layer, excluding indurated bedrock, that is little affected by soil-forming processes and does not have the properties typical of the A or B horizon. The material of a C horizon may be either like or unlike that in which the solum formed. If the material is known to differ from that in the solum, the Arabic numeral 2 precedes the letter C.

*R layer.* Consolidated rock beneath the soil. The rock commonly underlies a C horizon but can be directly below an A or a B horizon.

**Impervious soil.** A soil through which water, air or roots penetrate slowly or not at all. No soil is absolutely impervious to air and water all the time.

**Infiltration.** The downward entry of water into the immediate surface of soil or other material, as contrasted with percolation, which is movement of water through soil layers or material.

**Infiltration capacity.** The maximum rate at which water can infiltrate into a soil under a given set of conditions.

**Infiltration rate.** The rate at which water penetrates the surface of the soil at any given instant, usually expressed in inches per hour. The rate can be limited by the infiltration capacity of the soil or the rate at which water is applied at the surface.

**Intake rate.** The average rate of water entering the soil under irrigation. Most soils have a fast initial rate; the rate decreases with application time. Therefore, intake rate for design purposes is not a constant but is a variable depending on the net irrigation application. The rate of water intake in inches per hour is expressed as follows:

Less than 0.2 very low

0.2 to 0.4 low

0.7 to 0.75 moderately low

0.75 to 1.25 moderate

1.25 to 1.75 moderately high

1.75 to 2.5 high

More than 2.5 very high

**Loam.** Soil material that is seven to 27 percent clay particles, 28 to 50 percent silt particles and less than 52 percent sand particles.

**Loamy.** Soils ranging from moderately coarse textured to moderately fine textured soils.

**Medium textured soil.** Very fine sandy loam, loam, silt loam or silt.

**Metamorphic rock.** Rock of any origin altered in mineralogical composition, chemical composition or structure by heat, pressure and movement. Nearly all such rocks are crystalline.

**Moderately coarse textured soil.** Sandy loam and clay loam and silty clay loam.

**Moderately fine textured soil.** Clay loam, sandy clay loam and silty clay loam.

**Morphology, soil.** The physical make up the soil, including the texture, structure, porosity, consistence, color and other physical, mineral and biological properties of the various horizons and the thickness and arrangement of those horizons in the soil profile.

**Mottling, soil.** Irregular spots of different colors that vary in number and size. Mottling generally indicates poor aeration and impeded drainage. Descriptive terms are as follows: abundance, few, common and many; size, fine, medium and coarse; and contrast, faint, distinct and prominent. The size measurements are of the diameter along the greatest dimension. Fine indicates less than five millimeters (about 0.2 inch); medium, from five to 15 millimeters (about 0.2 to 0.6 inch); and coarse, more than 15 millimeters (about 0.6 inch).

**Muck.** Dark colored, finely divided, well decomposed organic soil material.

**Organic matter.** Plant and animal residue in the soil in various stages of decomposition.

**Pan.** A compact, dense layer in a soil that impedes the movement of water and the growth of roots. For example, hardpan, fragipan, claypan, plowpan, and land traffic pan.

**Parent material.** The unconsolidated organic and mineral material from which soil forms.

**Ped.** An individual natural soil aggregate, such as granule, a prism or a block.

**Pedon.** The smallest volume that can be called a soil. A pedon is three-dimensional and large enough to permit study of all horizons. Its area ranges from about 10 to 100 square feet (1 square meter to 10 square meters) depending on the variability of the soil.

**Percolation.** The downward movement of water through the soil.

**Permeability.** The quality of the soil that enables water to move downward through the profile. Permeability is measured as the number of inches per hour that water moves downward through the saturated soil. Terms describing permeability are:

*Very slow* - less than 0.06 inch/hr.

*Slow* - 0.06 to 0.2 inch/hr.

*Moderately slow* - 0.2 to 0.6 inch/hr.

*Moderate* - 0.6 to 2.0 inches/hr.

*Moderately rapid* - 2.0 to 6.0 inches/hr.

*Rapid* - 6.0 to 20 inches/hr.

*Very rapid* - more than 20 inches/hr.

**Similar Soil.** Soil that is different from the named soil but has the same interpretations as the named soil series.

**Plinthite.** The sesquioxide-rich, humus-poor, highly weathered mixture of clay with quartz and other diluents. It commonly appears as red mottles, usually in platy, polygonal or reticulate patterns. Plinthite changes irreversibly to an ironstone hardpan or to irregular aggregates on repeated wetting and drying, especially if it is exposed to heat from the sun. In a moist soil, plinthite can be cut with a spade. It is a form of laterite.

**Ponding.** Standing water on soils in closed depressions. Unless the soils are artificially drained, the water can be removed only by percolation or evapotranspiration.

**Poor filter.** Because of rapid permeability the soil may not adequately filter effluent from a waste disposal system.

**Profile, soil.** A vertical section of the soil extending through all its horizons and into the parent material.

**Runoff.** The precipitation discharged into stream channels from an area. The water that flows off the surface of the land without sinking into the soil is called surface runoff. Water that enters the soil before reaching surface streams is called groundwater runoff or seepage flow from groundwater.

**Sand.** As a soil separate, this is individual rock or mineral fragments from 0.5 millimeter to 2.0 millimeters in diameter. Most sand grains consist of quartz. As a soil textural class, a soil that is 85 percent or more sand and not more than 10 percent clay.

**Sandstone.** Sedimentary rock containing predominantly sand-size particles.

**Sedimentary rock.** Rock made up of particles deposited from suspension in water. The chief kinds of sedimentary rock are conglomerate, formed from gravel; sandstone, formed from sand; shale, formed from clay, and limestone, formed from soft masses of calcium carbonate. There are many intermediate types. Some wind-deposited sand is consolidated into sandstone.

**Seepage.** The movement of water through the soil. Seepage adversely affects the specified use.

**Series, soil.** A group of soils that have profiles that are almost alike, except for differences in texture of the surface layer or of the underlying material. All the soils of a series have horizons that are similar in composition, thickness and arrangement.

**Shale.** Sedimentary rock formed by the hardening of a clay deposit.

**Shrink-swell.** The shrinking of soil when dry and the swelling when wet. Shrinking and swelling can damage roads, dams, building foundations and other structures. It can also damage plant roots.

**Silica.** A combination of silicon and oxygen. The mineral form is called quartz.

**Slope.** The inclination of the land surface from the horizontal. Percentage of slope is the vertical distance divided by horizontal distance and then multiplied by 100. Thus, a slope of 20 percent is a drop of 20 feet in 100 feet or horizontal distance.

**Subsoil.** Technically, the B horizon; roughly, the part of the solum below plow depth.

**Subsurface layer.** Technically, the A2 or E horizon. Generally, refers to a leached horizon lighter in color and lower in content of organic matter than the overlying surface layer.

**Surface layer.** The soil ordinarily moved in tillage or its equivalent in uncultivated soil, ranging in depth from four to 10 inches (10 to 25 per centimeters). Frequently designated as the plow layer or the Ap horizon.

**Taxajunct.** A soil that is different in some minor property but has the same interpretations as the named soil series.

**Terrace.** An embankment or ridge, constructed across sloping soils on the contour or at a slight angle to the contour. The terrace intercepts surface runoff so that water soaks into the soil or flows slowly to a prepared outlet.

**Texture, soil.** The relative proportions of sand, silt and clay particles in a mass of soil. The basic textural classes, in order of increasing proportion of fine particles, are sand, loamy sand, sandy loam, loam, silt loam, silt, sand clay loam, clay loam, silty clay loam, sandy clay, silty clay and clay. The sand, loamy sand and sandy loam classes may be further divided by specifying coarse, fine or very fine.

**Topsoil.** The upper part of the soil, which is the most favorable material for plant growth. It is ordinarily rich in organic matter and is used to top dress road banks, lawns and land affected by mining.

**Variant.** A soil that has a major difference in properties and interpretations than the named soil series.

**Weathering.** All physical and chemical changes produced in rocks or other deposits at or near the earth's surface by atmospheric agents. These changes result in disintegration and decomposition of the material.

## 6) Saturated Hydraulic Conductivity Guidance

Guidelines for Measurement of Saturated Hydraulic Conductivity by the Constant Head Permeameter Method for On-Site Sewage Management Systems in Georgia

- A. *Purpose* - The purpose of this section is to assist certified or registered professionals in the collection, interpretation, and submission of saturated hydraulic conductivity (Ks) data to the local environmental health specialists for permitting on-site sewage management systems (OSSMS). This guidance section is specific to the constant-head well permeameter method (also known as "borehole permeameter method" or "constant-head borehole infiltration test"). These recommendations were developed by private and public industry professionals as well as Department of Public Health (DPH) staff. Ks data may only be collected and reported by certified soil scientists, registered professional geologists, or registered professional engineers currently approved by the department to conduct soil evaluations. With appropriate documentation, certified and registered professionals may submit alternative methods of Ks data collection that are not covered in this section. The following guidance is not intended to replace education or experience and should be used in conjunction with professional judgement.
- B. *Equipment* - A commercially available permeameter or similar device for maintaining a constant depth of water in a cylindrical auger hole at a desired depth and measuring the flow rate of water into the soil. An auger set (including a cutting head, planer or hole cleaner, brush, and extensions) for boring a cylindrical hole typically 2 to 4 inches in

diameter. Any additional equipment specified/recommended in the respective procedure or by the manufacturer of the permeameter.

### C. Evaluation Procedure

1. *Measurement location and replication* - Field assessment of the variability of soil type, landscape position and proposed system capacity by the approved professional determines the appropriate location of measurements and number of replicates necessary to characterize the hydraulic conductivity of the primary absorption field and repair area. Guidance from the *NRCS Field Book for Describing and Sampling Soils, Version 3.0*, suggests five (5) or more Ks measurements are required to capture natural variation. Justification should be provided for the number and locations of the measurements performed. At a minimum, measure Ks at the depths as described below.
  - a. Daily design peak flow  $\leq 750$  gpd – DPH recommends measurements of Ks at five (5) locations that best characterize the soil and site conditions within the area to be used for the primary and repair OSSMS installation at the site. If the area to be used for the proposed primary and secondary systems is not contiguous, DPH advises taking measurements at an additional five (5) locations in the secondary area. Describe and justify deviations from the procedures suggested here.
  - b. *Daily design peak flow > 750 gpd* – DPH recommends measurements of Ks at five (5) locations that best characterize the soil and site conditions within the area to be used for the primary OSSMS installation at the site. Additionally, measure Ks at five (5) locations within the area to be used for the secondary OSSMS installation, regardless of whether the secondary system area is contiguous with the primary area. Please describe and justify deviations from the procedures suggested here.
2. *Measurement depths* - Conduct measurements in the most restrictive soil horizon that encounters the proposed absorption trench sidewall and for one foot below the proposed absorption trench bottom elevation. Because of potential water flow to the surface, only Ks measurements at depths greater than six (6) inches from the ground surface are generally considered valid. Where appropriate, conduct measurements within a single horizon. Avoid inclusion of more than one (1) horizon (i.e., straddling two [2] or more horizons) if the thickness of the master (O, A, E, B, or C) horizon under consideration is greater than the required depth of the water in the hole. Thin horizons with similar soil properties may be bridged if necessary. Select the depth of water in the hole as described in the recommendations outlined in the respective procedures and maintain it constantly throughout the test. For commercial devices, consult the manufacturer's manual for selection of an appropriate water depth. Provide a description of any deviation from respective recommendations.
3. *Steady state* - Achieve steady state equilibrium at each test. Provide an explanation if steady state equilibrium is not achieved. Where the measurement is conducted under a constant depth of water, steady state condition for Ks can be defined as the time during which the rate of water flow from the hole reaches a constant value (i.e., no longer changes with time). Steady state is achieved when three (3) consecutive flow rate

measurements are the same. Alternately, after allowing saturation of the soil around the hole, flow rate should reach a quasi-steady state condition during which it varies around an average value. To determine this average, it is best to plot the rate of water flow (or the calculated Ks values) versus time and pass a smooth curve through them using a manually (referred to as fitting a curve by eye) or a mathematically (e.g., statistically) best fitted curve. The steady state flow rate is reached if the tail end of this fitted curve is nearly horizontal without showing an upward or downward trend. Use the arithmetic mean flow rate for the last three (3) to five (5) measurements after reaching steady state to calculate Ks. Longer saturation times should be considered for soils with mixed clay mineralogy and moderate to high shrink-swell potential (Amoozegar 1997) or for droughty conditions.

4. *Measurement recording frequency* - Measure Ks at time intervals outlined in the respective procedures or manufacturer's instrument-specific manual. In general, for Group II and III soil textures, measure and record at intervals of 15 minutes (or at least 100 cm<sup>3</sup> of water flow into the soil) for a minimum run time of one (1) hour or until steady state is achieved. For Group IV soil textures, measure and record at intervals of 30 minutes (or at least 100 cm<sup>3</sup> of water flow into the soil) for a minimum run time of four (4) hours and until steady state is achieved.
5. *Data analysis* – If multiple readings vary by an order of magnitude or more, additional measurements should be considered to achieve an acceptable level of confidence as determined by the professional. Because the soil property Ks is logarithmically distributed, the geometric mean of flow measurements must be used for calculations. For example, the geometric mean of the number set {1,2,3,4,5} would be as follows:

$$\sqrt[5]{1 \times 2 \times 3 \times 4 \times 5} = 2.6$$

#### D. Record Keeping

1. *Data log* - At a minimum, a report should include, but is not limited to: date, time, and weather conditions when data were collected, description of methodology, equipment type used, soil profile descriptions for all borings including measurement borings, locator map showing location of all Ks measurements and borings, adequate description of constants and equations used.
2. *Report the following for each measurement* - Auger hole diameter, depths of measurements, depth of water in the hole under the constant head, saturation start time and steady state time, clock time, reservoir readings, change in time, change in the water level in the permeameter, flow volume, flow rate (flow volume/time), graph of rate of water flow (or calculated Ks values) vs. time.

#### E. Results and Interpretations

1. *Recommended equation for calculation of Ks:*

*Reynolds and Elrick (2002) Equation:*

$$K_s = \frac{Q_s}{\left(\pi r^2 + \frac{H\lambda_c}{G} + \frac{H^2}{G}\right)}$$

Where  $Q_s$  is the steady volumetric flow rate in volume of water per unit time,  $H$  is the height of water ponded in the borehole,  $r$  is the radius of the hole in centimeters,  $\lambda_c$  is the soil macroscopic capillary length, and  $G$  is the unitless geometric factor. Bosch and West (1997) developed an equation to determine the value of  $G$ :

$$G = \frac{1}{2\pi} \left[ A_1 + A_2 \left(\frac{H}{r}\right) + A_3 \left(\frac{H}{r}\right)^2 + A_4 \left(\frac{H}{r}\right)^3 \right]$$

The values of the coefficients  $A_1$ ,  $A_2$ ,  $A_3$ , and  $A_4$  in this polynomial depend on texture and structure and are shown in the table below, along with values for  $\lambda_c$ .

Soil Texture/Structure	$\lambda_c$ (cm)	$A_1$	$A_2$	$A_3$	$A_4$
I. Coarse and gravelly sands; may also include some highly structured soils with large cracks and/or macropores	2.8	0.079	0.516	-0.048	0.002
II. Most structured soils from clays through loams; also includes unstructured medium and fine sands	8.3	0.083	0.514	-0.053	0.002
III. Soils which are both fine textured (clayey) and unstructured	25	0.094	0.489	-0.053	0.002

2. *Comparison of Ks and Percolation Rate* – A mathematically modeled relationship between percolation rate and Ks was developed using the equations of Reynolds (2016) and can be referenced in the Table under paragraph E.4. If measured values are slower than anticipated based on observed soil morphology, DPH recommends using the measured values with appropriate adjustments for soil conditions and site limitations. If, however, measured values are higher than anticipated, DPH recommends the professional consider using those predicted from assessing soil morphology in the field along with appropriate site-specific adjustments. The reported percolation rate may not exceed the maximum values for each soil texture group as listed in the Georgia Manual for On-Site Sewage Management Systems or approved product sizing tables.
3. *Reporting of Results* – If required, the Ks report used to support soil interpretations must be submitted with the Level 4 (special study) used for site permitting. Complete reports include the date of completion and signature and seal of the Certified Soil Classifier, Professional Geologist, or Professional Engineer providing the service. The Soil Classifier, Engineer, or Geologist who performed the submitted Level 4 soil report is responsible for measured data interpretations and the determination of percolation rate or loading rate (reported in gallons/ft<sup>2</sup>/day). The Level 4 soil report must meet or

exceed all requirements listed in Section C of the Manual for On-Site Sewage Management Systems.

4. *Percolation Rate compared with Ks Table User Notes* – This correlation was derived from calculating the volume of water per unit time passing through a borehole with radius of 5.1 cm (2 inches) and a constant pressure head of 15.2 cm (6 inches). It was also assumed the soil had been prewetted. These conditions match those prescribed in the Modified Taft Engineering Center Method, which is the currently approved method for determining soil percolation rate in the Georgia Manual for On-Site Sewage Management Systems. The Reynolds and Elrick (2016) equation was used to determine Ks. This table should not be used as a reference for Ks values calculated with other equations.

**Most Structured and Medium Textured Soils**

Soil Group	$K_{fs}$ (cm/day)	$K_{fs}$ (in/day)	Percolation Rate (min/in)
Group I - Sands Sand and Loamy Sand	83.81	33.00	5
	41.91	16.50	10
	28.85	11.36	15
	21.63	8.52	20
	17.31	6.81	25
Group II - Coarse Loams Sandy Loam and Loam	14.42	5.68	30
	12.36	4.87	35
	10.82	4.26	40
	9.62	3.79	45
	8.65	3.41	50
Group III - Fine Loams Clay Loam, Silt Loam, Sandy Clay Loam, Silty Clay Loam, Silt	7.87	3.10	55
	7.21	2.84	60
	6.66	2.62	65
	6.18	2.43	70
	5.77	2.27	75
	5.41	2.13	80
	5.34	2.10	85
Group IV - Clays Sandy Clay, Clay, Silty Clay with 1:1 minerals	5.04	1.98	90
	4.78	1.88	95
	4.54	1.79	100
	4.32	1.70	105
	4.12	1.62	110
3.94	1.55	115	
3.78	1.49	120	

Table developed by Thomas Martin, 1/30/2026.

$K_{fs}$  - Field-Saturated Soil Hydraulic Conductivity

The  $K_{fs}$  to PT correlation assumes a static water head of 6.0 inches and a borehole radius of 4.0 inches with an antecedent pore water pressure head of -10 cm.

$K_{fs}$  and PT were correlated using W. D. Reynolds' equations 1, 2, and 16 and Table 2, A Unified Test-Well Permeameter Methodology for Absorption Field Investigations, Geoderma 264 (2016) 160-170 and equations 5 and 6 and Tables 4 and 5, Drainfield Flow Characteristics Inferred from Percolation Test and Hydraulic Conductivity Data, Journal of Hydrology 661 (2025) 133675.

$K_{fs}$  and PT values assume structured and medium textured soils, including structured clayey and loamy soils, as well as medium single-grain sands, with a dry-soil representative sorptive number ( $\alpha^*$ ) of  $0.12 \text{ cm}^{-1}$ .

$K_{fs}$  values assume the background pore water pressure head is sufficiently negative to produce near-maximum soil capillarity at the time of testing.

Soil Groups are based on Table 8.F in the Georgia Manual for On-Site Sewage Management Systems (2019).

This correlation table may not be appropriate for massive, fine textured soils.

## 7) Tables, Figures and Forms

**Table 1.C Soil Series Suitability Codes**

*These codes are general statements of soil suitability and limitations for their use for on-site systems. As such, they are based on the range of conditions given for the soils as they occur statewide. Suitability codes and installation recommendations submitted to County Boards of Health by qualified individuals should be based on data from their site-specific evaluation and may commonly differ from the general statements below.*

<b>Suitability Codes</b>	
A	These soils are suitable for installation of on-site systems with proper system design, installation, and maintenance. Position of the site or other soil and landscape considerations may require the drainfield area to be greater than the minimum and/or the drainfield design to require equal distribution or level field installation.
C	Because of flooding, shallow seasonal water tables, soil horizons with very slow percolation rate, perched water tables, or imperfect drainage, these soils are not suitable for installation of a conventional on-site system without site modifications, special designs or installation. Properties of the soil and site may require the drainfield area to be greater than the minimum and/or the drainfield design to require equal distribution or level field installation. Non-conventional systems and installation must be approved by the local Environmental Health Specialist.
F	Because of soil limitations, these soils are unsuitable for installation of an on-site system.
H	These soils have bedrock limitations and are not suitable for installation of a conventional on-site system without special design or installation. Properties of the soil and site may require the drainfield area to be greater than the minimum and/or the drainfield design to require equal distribution or level field installation. Non-conventional system design and installation must be approved by the local Environmental Health Specialist.
G	Because of severe slope conditions, on-site installation is not recommended.
J	These soils commonly have percolation rates that are too slow for installation of a conventional on-site system without special design or installation. Some areas may have favorable rates, which can be identified through intensive investigation. Properties of the soil and site may require the drainfield area to be greater than the minimum and/or the drainfield design to require equal distribution or level field installation. Non-conventional system design and installation must be approved by the local Environmental Health Specialist.
K	These soils are suitable for installation of an on-site system. Shallow bedrock is common in this area; however, small areas of soils with shallow bedrock may occur as inclusions in these map units. It is recommended that intensive investigations be made or that the on-site system is installed prior to home construction to ensure bedrock limitations are not present on the site.

N	Because of soft bedrock at a shallow depth, these soils typically are not suitable for installation of a conventional on-site system. Hydraulic properties of the rock vary, however, and in some areas, the soft rock has a percolation rate suitable for on-site system installation. Intensive investigations are required to evaluate hydraulic properties of the rock and site suitability. On-site system installation before home construction may be required to ensure the system can be properly installed. Properties of the soil and site may require the drainfield area to be greater than the minimum and/or the drainfield design to require equal distribution or level field installation. Non-conventional system design and installation must be approved by the local Environmental Health Specialist.
P	These soils have deep seasonal water tables that require shallow installation of on-site system drainfields. Intensive investigations and data collection may be needed to ensure percolation rates in shallow horizons have suitable percolation rates. Properties of the soil and site may require the drainfield area to be greater than the minimum and/or the drainfield design to require equal distribution or level field installation. Design and installation of an alternative system in these soils must be approved by the local Environmental Health Specialist.
R	These soils are suitable for installation of an on-site system. However, they are very rocky or stony which may require design modifications including increased drainfield area and special measures for excavations and system installation.
S	These soils have seasonal water tables and are commonly poorly suited for conventional on-site system installation. Very shallow, above ground, and other system designs may allow the site to be used. Design and installation of an alternative system in these soils must be approved by the local Environmental Health Specialist.
U	These soils are generally suitable for installation of on-site systems. However, slowly permeable subsoil horizons may result in short periods of saturated soils that impede on-site system function. Shallow installation of the drainfield trenches along with site water management will minimize this problem.

**Table 2.C Soil Series Suitability**

*The suitability code information in this table should be used as a guide. They are based on the range of conditions for the soils as they occur state wide. A qualified Soil Classifier may assign properties or installation recommendations to the soils encountered onsite in a way not shown in this table. The Soil Classifier may report soils not listed in this table. The Soil Classifier's report will be based on specific findings from the particular site being mapped. Suitability information or "codes" will be developed and reported based on the Classifier's on-site investigation. As a minimum, suitability codes and statements will describe the soil's limitations and its capability of functioning with a particular type of on-site wastewater management system. If a site is not*

*suitable for use, the suitability code will state the nature of the soil limitation. Recommendations, specific details and concerns surrounding any particular site which deal with system performance and longevity are explained within the suitability code for the soil series.*

Soil Series See Suitability Codes and Installation Information	MLRA Major Land Resource Area	Slope % Ranges of the soil type	Depth to Bedrock (ranges)	Bedrock Hardne ss	Depth to Seasonal High H2O Table (inches)	Suitability Code and Installation Information
HAMBLEN	Sand Mountain	0-3%	>60"		24-36"	C
HARTSELLS	Sand Mountain	2-45%	20-40"	HARD	>72"	H
HECTOR	Sand Mountain	1-60%	10-20"	HARD	>72"	H
HECTOR (STONY)	Sand Mountain	2 - 60%	10-20"	HARD	>72"	H
LINKER	Sand Mountain	1-40%	20-40"	HARD	>72"	H
NAUVOO	Sand Mountain	2-35%	40-60"	SOFT	>72"	A
ALBERTVILLE	Ridges and Valleys	2-25%	40-60"	SOFT	>72"	N
ALLEN	Ridges and Valleys	2-40%	>60"		>72"	A
APISON	Ridges and Valleys	2-25%	20-40"	SOFT	>72"	H
ARAGON	Ridges and Valleys	2-25%	>60"		>72"	J
ARKABUTLA	Ridges and Valleys	0-2%	>60"		12-18"	C
ARMUCHEE	Ridges and Valleys	5-60%	20-36"	SOFT	>72"	H
BARFIELD	Ridges and Valleys	1-50%	8 - 20"	HARD	> 72"	H
BELLAMY	Ridges and Valleys	0 - 6%	> 60"		18 - 36"	C
BIGFORK	Ridges and Valleys		40 - 60"	HARD	> 72"	A
BODINE	Ridges and Valleys	5-70%	>60"		>72"	A
CAPSHAW	Ridges and Valleys	0-12%	40-80"	HARD	24-42"	<i>unsuitable</i>
CARTECAY	Ridges and Valleys	0-5%	>60"		6-18"	C
CEDARBLUFF	Ridges and Valleys	0-2%	>60"		6-12"	C
CHENNEBY	Ridges and Valleys	0-2%	>60"		12-30"	C
CHEWACLA	Ridges and Valleys	0-2%	>60"		6-24"	C
CONASAUGA	Ridges and Valleys	0-45%	20-40"	SOFT	>72"	<i>unsuitable</i>
CRAIGSVILLE	Ridges and Valleys	0 - 5%	> 60"		> 72"	C
CRAIGSVILLE (GRAVELLY)	Ridges and Valleys	0-5%	>60"		>72"	C
CUNNINGHAM	Ridges and Valleys	2-25%	40-60"	SOFT	>72"	J
DECATUR	Ridges and Valleys	1-25%	>60"		>72"	A
DEKALB	Ridges and Valleys	0-80%	20-40"	HARD	>72"	H
DEWEY	Ridges and Valleys	2-40%	>60"		>72"	A
DOCENA	Ridges and Valleys	0-6%	>60"		18-36"	C
DOWELLTON	Ridges and Valleys	0-8%	40-60"	HARD	6-12"	<i>unsuitable</i>
EMORY	Ridges and Valleys	0-5%	>60"		60-72"	C
ENDERS	Ridges and Valleys	1-65%	40 - >60"	SOFT	>72"	J
ENNIS	Ridges and Valleys	0-5%	>60"		>72"	C
ETOWAH	Ridges and Valleys	0-35%	>60"		>72"	A
EUHARLEE	Ridges and Valleys	2-10%	>60"		>72"	A

Soil Series See Suitability Codes and Installation Information	MLRA Major Land Resource Area	Slope % Ranges of the soil type	Depth to Bedrock (ranges)	Bedrock Hardne ss	Depth to Seasonal High H <sub>2</sub> O Table (inches)	Suitability Code and Installation Information
FARRAGUT	Ridges and Valleys	2-20%	48 - > 60	SOFT	>72"	A
FULLERTON	Ridges and Valleys	2-45%	>60"		>72"	A
GORGAS	Ridges and Valleys	2-70%	10-20"	HARD	>72"	H
GORGAS (STONY- COBBLY)	Ridges and Valleys	2-70%	10-20"	HARD	>72"	H
GUTHRIE	Ridges and Valleys	0-2%	>60"		6-12"	C
HAMBLEN	Ridges and Valleys	0-3%	>60"		24-36"	C
HANCEVILLE	Ridges and Valleys	0-40%	> 60"	SOFT	>72"	A
HARTSELLS	Ridges and Valleys	2-45%	20-40"	HARD	>72"	H
HECTOR	Ridges and Valleys	1-60%	10-20"	HARD	>72"	H
HOLSTON	Ridges and Valleys	0-25%	>60"		>72"	A
KETONA	Ridges and Valleys	0-2%	40-72"	HARD	6-12"	<i>unsuitable</i>
KETONA (PONDED)	Ridges and Valleys	0-4%	40-72"	HARD	0 - 12"	<i>unsuitable</i>
LEADVALE	Ridges and Valleys	0-15%	48 - >60"	SOFT	0 - 12"	C
LEESBURG	Ridges and Valleys	2-45%	>60"		>72"	A
LILY	Blue Ridge	0 - 65%	20-40"	HARD	>72"	H
LINKER	Ridges and Valleys	1-40%	20-40"	HARD	>72"	H
LOCUST	Ridges and Valleys	0-10%	>60"		18-24"	C
LYERLY	Ridges and Valleys	1-10%	20-40"	HARD	>72"	H
MINVALE	Ridges and Valleys	2-45%	>60"		>72"	A
MONTEVALLO	Ridges and Valleys	2-80%	10-20"	SOFT	>72"	H
MOUNTAINBURG	Ridges and Valleys	1 - 65%	12-20"	HARD	> 72"	H
MOUNTAINBURG (STONY)	Ridges and Valleys	1-65%	12-20"	HARD	>72"	H
NAUVOO	Ridges and Valleys	2-35%	40-60"	SOFT	>72"	A
NELLA	Ridges and Valleys	2-60%	>60"		>72"	A
NELLA (STONY)	Ridges and Valleys	2-60%	>60"		>72"	A
PANAMA	Ridges and Valleys	12 -70%	> 60"		42 - 60"	A
PANAMA (GRAVELLY)	Ridges and Valleys	12-70%	> 60"		42-60"	A
RIVERVIEW	Ridges and Valleys	0-5%	>60"		36-60"	
ROANOKE	Ridges and Valleys	0-2%	>60"		0-12"	<i>unsuitable</i>
ROANOKE (PONDED )	Ridges and Valleys	0-2%	>60"		< 10"	<i>unsuitable</i>
ROME	Ridges and Valleys	0-6%	>60"		>72"	A
SEQUATCHIE	Ridges and Valleys	0-12%	>60"		>72"	A
SHACK	Ridges and Valleys	2-25%	>60"		24-48"	C
SHELLBLUFF	Ridges and Valleys	0-3%	>60"		36-60"	C
SIPSEY	Ridges and Valleys	4-30%	20-40"	SOFT	>72"	H
STASER	Ridges and Valleys	0-3%	>60"		36-48"	C
STEEKEE	Ridges and Valleys	10 -50%	20 - 40"	HARD	> 72"	H
SUBLIGNA	Ridges and Valleys	1-6%	>60"		>72"	C
SULLIVAN	Ridges and Valleys	0-2%	>60"		48-72"	C

Soil Series See Suitability Codes and Installation Information	MLRA Major Land Resource Area	Slope % Ranges of the soil type	Depth to Bedrock (ranges)	Bedrock Hardne ss	Depth to Seasonal High H <sub>2</sub> O Table (inches)	Suitability Code and Installation Information
SUNLIGHT	Ridges and Valleys	8 - 60%	10 - 20"	SOFT	> 72"	<b>H</b>
TAFT	Ridges and Valleys	0 - 2%	> 60"		12 - 24"	<b>C</b>
TALBOTT	Ridges and Valleys	0-70%	20-40"	HARD	>72"	<i>unsuitable</i>
TANYARD	Ridges and Valleys	0 - 2%	> 60"		18 - 30"	<b>C</b>
TIDINGS	Ridges and Valleys	2-70%	40-60"	HARD	>72"	<b>A</b>
TOCCOA	Ridges and Valleys	0-4%	>60"		30-60"	<b>C</b>
TOWNLEY	Ridges and Valleys	2-60%	20-40"	SOFT	>72"	<i>unsuitable</i>
TOWNLEY (GRAVELLY)	Ridges and Valleys	2-60%	20-40"	SOFT	>72"	<i>unsuitable</i>
TUPELO	Ridges and Valleys	0-6%	>60"		12-24"	<i>unsuitable</i>
WAX	Ridges and Valleys	0-6%	>60"		18-36"	<b>C</b>
WAYNESBORO	Ridges and Valleys	2-30%	>60"		>72"	<b>A</b>
WEHADKEE	Ridges and Valleys	0-2%	>60"		0-12"	<i>unsuitable</i>
WHITWELL	Ridges and Valleys	0-6%	>60"		24-36"	<b>C</b>
WOLFTEVER	Ridges and Valleys	0-12%	>60"		30-42"	<b>C</b>
ARKAQUA	Blue Ridge	0-5%	>60"		18-24"	<b>C</b>
ASHE	Blue Ridge	2-95%	20-40"	HARD	>72"	<b>H</b>
ASHE (VERY STONY)	Blue Ridge	2-95%	20-40"	HARD	>72"	<b>H</b>
BANDANA	Blue Ridge	0-5%	>60"		18-24"	<b>C</b>
BILTMORE	Blue Ridge	0-5%	>60"		>42"	<b>C</b>
BRADDOCK	Blue Ridge	0-35%	>60"		>60"	<b>J</b>
BRADSON	Blue Ridge	0-35%	>60"		>60"	<b>J</b>
BRASSTOWN	Blue Ridge	2 - 95%	40-60"	SOFT	> 72	<b>K</b>
BREVARD	Blue Ridge	0-35%	>60"		>60"	<b>A</b>
BULADEAN	Blue Ridge	2 - 95%	40-60"	SOFT	> 72	<b>K</b>
BURTON	Blue Ridge	5-95%	20-40"	HARD	>72"	<b>H</b>
CASHIERS	Blue Ridge	2 - 95%	> 60"		> 72"	<b>A</b>
CATASKA	Blue Ridge	2 -95%	10-20"	SOFT	>72"	<b>H</b>
CHANDLER	Blue Ridge	2-95%	>60"		>72"	<b>A</b>
CHATUGE	Blue Ridge	0-15%	>60"		12-24"	<b>C</b>
CHEOAH	Blue Ridge	8-95%	40-60"	SOFT	>72"	<b>K</b>
CHESTNUT	Blue Ridge	2-95%	20-40"	SOFT	>72"	<b>H</b>
CLEVELAND	Blue Ridge	2-95%	10 - 20"	HARD	>72"	<b>H</b>
CLIFFIELD	Blue Ridge	2-95%	20 - 40"	HARD	>72"	<b>H</b>
CLIFTON	Blue Ridge	2 - 60%	>60"		>72"	<b>A</b>
CODORUS	Blue Ridge	0-5%	>60"		12-24"	<b>C</b>
COLVARD	Blue Ridge	0-5%	>60"		>48"	<b>C</b>
COWEE	Blue Ridge	2-95%	20-40"	SOFT	>72"	<b>H</b>
CULLASAJA	Blue Ridge	0-35%	>60"		>60"	<b>R</b>
CULLOWHEE	Blue Ridge	0-5%	>60"		18-24"	<b>C</b>
DELANCO	Blue Ridge	0-15%	>60"		12-30"	<b>C</b>

Soil Series See Suitability Codes and Installation Information	MLRA Major Land Resource Area	Slope % Ranges of the soil type	Depth to Bedrock (ranges)	Bedrock Hardne ss	Depth to Seasonal High H <sub>2</sub> O Table (inches)	Suitability Code and Installation Information
DELLWOOD	Blue Ridge	0-5%	>60"		24-48"	C
DILLARD	Blue Ridge	0-15%	>60"		24-36"	C
DILLSBORO	Blue Ridge	0-35%	>60"		>60"	A
DYKE	Blue Ridge	0-35%	>60"		>60"	A
DYKE (STONY)	Blue Ridge	0-35%	>60"		>72"	A
EDNEYTOWN	Blue Ridge	2 - 95%	>60"		>72"	A
EDNEYTOWN (VERY STONY)	Blue Ridge	2-80%	>60"		>72"	A
EDNEYVILLE	Blue Ridge	2-95%	>60"		>72"	A
EDNEYVILLE (STONY)	Blue Ridge	2-95%	>60"		>72"	A
ELLIJAY	Blue Ridge	2-95%	>60"		>72"	J
ELSINBORO	Blue Ridge	0-35%	>60"		>60"	A
EVARD	Blue Ridge	2-95%	>60"		>72"	A
FANNIN	Blue Ridge	2-95%	>60"		>72"	A
FRENCH	Blue Ridge	0-5%	>60"		12-30"	C
GREENLEE	Blue Ridge	0-35%	>60"		>60"	R
HANMILLER	Blue Ridge	2 - 95%	20 - 40"	SOFT	>72"	H
HATBORO	Blue Ridge	0-5%	>60"		0-6"	C
HAYESVILLE	Blue Ridge	2-60%	>60"		>72"	A
HAYWOOD	Blue Ridge	0-35%	>60"		>60"	A
HAYWOOD (STONY)	Blue Ridge	2-45%	>60"		>72"	A
HEMPHILL	Blue Ridge	0-15%	>60"		0-12"	<i>unsuitable</i>
HIWASSEE	Blue Ridge	0-35%	>60"		>60"	J
HUNTDAL	Blue Ridge	2 - 95%	>60"		>72"	A
IOTLA	Blue Ridge	0-5%	>60"		18-24"	C
JEFFERSON	Blue Ridge	2-75%	>60"		>72"	A
JEFFERY	Blue Ridge	2 - 95%	20 - 40"	HARD	>72"	H
JUNALUSKA	Blue Ridge	2 - 95%	20-40"	SOFT	>72"	H
KEENER	Blue Ridge	0-35%	>60"		>60"	A
KIWKORA	Blue Ridge	0-15%	>60"		0-12"	<i>unsuitable</i>
LILY	Blue Ridge	0-65%	20-40"	HARD	>72"	H
LONON	Blue Ridge	0-35%	>60"		>60"	A
LOSTCOVE	Blue Ridge	0-35%	>60"		>60"	R
MAYMEAD	Blue Ridge	0-35%	>60"		>60"	A
MICAVILLE	Blue Ridge	2 - 95%	40 - 60"	SOFT	>72"	K
NANTAHALA	Blue Ridge	2 - 60%	40 - 60"	SOFT	>72"	J, K
NIKWASI	Blue Ridge	0-5%	>60"		0 - 12"	C
NORTHCOVE	Blue Ridge	0-35%	>60"		>60"	R
OSTIN	Blue Ridge	0-5%	>60"		>42"	C
PIGEONROOST	Blue Ridge	2 - 95%	20-40"	SOFT	>72"	H
PLOTT	Blue Ridge	2 - 95%	>60"		>72"	A

Soil Series See Suitability Codes and Installation Information	MLRA Major Land Resource Area	Slope % Ranges of the soil type	Depth to Bedrock (ranges)	Bedrock Hardne ss	Depth to Seasonal High H2O Table (inches)	Suitability Code and Installation Information
PORTERS	Blue Ridge	2 - 95%	40-60"	HARD	>72"	K
PORTERS (STONY)	Blue Ridge	6-95%	40-60"	HARD	>72"	K
RABUN	Blue Ridge	2-50%	>60"		>72"	A
RABUN (STONY)	Blue Ridge	7-70%	>60"		>72"	A
RAMSEY	Blue Ridge	3 - 70%	10 - 20"	HARD	> 72"	H
RAMSEY (STONY)	Blue Ridge	3-70%	10-20"	HARD	>72"	H
REDDIES	Blue Ridge	0-5%	>60"		24-42"	C
ROSMAN	Blue Ridge	0-5%	>60"		30-60"	C
SALUDA	Blue Ridge	2 - 95%	10-20"	SOFT	>72"	H
SAWTEETLAH	Blue Ridge	0-35%	>60"		>60"	A
SAVNOOK	Blue Ridge	0-35%	>60"		>60"	A
SHELOCTA	Blue Ridge	0-35%	>60"		>60"	A
SHINBONE	Blue Ridge	2 - 95%	40 - 60"	SOFT	> 72"	K
SHOUNS	Blue Ridge	0-35%	>60"		>60"	A
SOCO	Blue Ridge	2 - 95%	20 - 40"	SOFT	> 72"	H
SPIVEY	Blue Ridge	0-35%	>60"		>60"	R
STATLER	Blue Ridge	0-35%	>60"		>60"	A
STELCOAH	Blue Ridge	2-95%	40-60"	SOFT	>72"	K
SUCHES	Blue Ridge	0-5%	>60"		30-48"	C
SYLCO	Blue Ridge	2-95%	20-40"	HARD	>72"	H
SYLVA	Blue Ridge	0-10%	>60"		0-12"	C
TALLADEGA	Blue Ridge	6-80%	20-40"	SOFT	>72"	H
TATE	Blue Ridge	0-35%	>60"		>60"	A
THUNDER	Blue Ridge	0-35%	>60"		>60"	R
THURMONT	Blue Ridge	0-35%	>60"		>60"	A
TOECANE	Blue Ridge	0-35%	>60"		>60"	R
TOCCOA	Blue Ridge	0-4%	>60"		30-60"	C
TOXAWAY	Blue Ridge	0-5%	>60"		0-6"	C
TRANSYLVANIA	Blue Ridge	0-5%	>60"		24-36"	C
TRIMONT	Blue Ridge	2-95%	>60"		>72"	A
TSALI	Blue Ridge	2-95%	10-20"	SOFT	>72"	H
TUCKASEGEE	Blue Ridge	0-35%	>60"		>60"	A
TUSQUITEE	Blue Ridge	0-35%	>60"		>60"	A
TUSQUITEE (STONY)	Blue Ridge	2-95%	>60"		>72"	A
UNAKA	Blue Ridge	2-95%	20-40"	HARD	>72"	H
UNISON	Blue Ridge	0-35%	>60"		>60"	A
WATAUGA	Blue Ridge	2-95%	>60"		>72"	A
WHITEOAK	Blue Ridge	0-35%	>60"		>60"	A
WHITESIDE	Blue Ridge	0-10%	>60"		18-36"	C
ALAMANCE	Southern Piedmont	0 - 15%	> 60		> 72"	A
ALCOVY	Southern Piedmont	2-10%	>60"		24 - 36"	C

Soil Series See Suitability Codes and Installation Information	MLRA Major Land Resource Area	Slope % Ranges of the soil type	Depth to Bedrock (ranges)	Bedrock Hardne ss	Depth to Seasonal High H2O Table (inches)	Suitability Code and Installation Information
ALLEN	Southern Piedmont	2-40%	>60"		>72"	
ALTAVISTA	Southern Piedmont	0-10%	>60"		18-30"	<b>C</b>
APPLING	Southern Piedmont	0-25%	>60"		>72"	<b>A</b>
ASHLAR	Southern Piedmont	0-70%	20-40"	HARD	>72"	<b>H</b>
AUGUSTA	Southern Piedmont	0-2%	>60"		12-24"	<b>C</b>
BADIN	Southern Piedmont	2-55%	40 - 60"	HARD	>72"	<i>unsuitable</i>
BETHLEHEM	Southern Piedmont	2 - 45%	20 - 40"	SOFT	>72"	<b>N</b>
BUCKHEAD	Southern Piedmont	6-45%	> 60"		> 72"	<b>A</b>
BUNCOMBE	Piedmont & Coastal Plain	0 - 6%	> 60"		> 72"	<b>C</b>
CARTECAY	Southern Piedmont	0-5%	>60"		6-18"	<i>unsuitable</i>
CATAULA	Southern Piedmont	2-25%	> 60"		24 - 48	<b>C</b>
CECIL	Southern Piedmont	0-25%	>60"		>72"	<b>A</b>
CHENNEBY	Southern Piedmont	0-2%	>60"		12-30"	<i>unsuitable</i>
CHESTATEE	Southern Piedmont	10 -50%	>60"		>72"	<b>A</b>
CHEWACLA	Southern Piedmont	0-2%	>60"		+ 12" - 24"	<i>unsuitable</i>
COLFAX	Southern Piedmont	0-15%	>60"		6 - 18"	<b>C</b>
CONGAREE	Southern Piedmont	0-4%	>60"		30 - 48"	<b>C</b>
DAVIDSON	Southern Piedmont	2-25%	>60"		>72"	
DURHAM	Southern Piedmont	0-10%	>60"		>72"	<b>A</b>
DURHAM (PERCHED)	Southern Piedmont	0 - 10%	> 60"		48 - 72	<b>C</b>
ENON	Southern Piedmont	2-45%	>60"		>72"	<b>J</b>
FORK	Southern Piedmont	0-7%	>60"		12-24"	<b>C</b>
GEORGEVILLE	Southern Piedmont	2 - 50%	>60"		>72"	<b>A</b>
GOLDSTON	Southern Piedmont	2-60%	20 - 40"	HARD	>72"	<i>unsuitable</i>
GROVER	Southern Piedmont	2-45%	>60"		>72"	<b>A</b>
GUNDY	Southern Piedmont	6 - 40%	40 - 72"	SOFT	> 72"	
GWINNETT	Southern Piedmont	2-60%	40-60"	SOFT	>72"	<b>A or N</b>
HARD LABOR phase one	Southern Piedmont	0 - 15%	> 72"	NA	30 - 48"	<b>C</b>
HARD LABOR phase two	Southern Piedmont	0 - 15%	> 72"	NA	48- 60"	<b>P</b>
HELENA	Southern Piedmont	0-15%	>60"		18-30"	<i>unsuitable</i>
HERNDON	Southern Piedmont	2-25%	>60"		>72"	<b>A</b>
HIWASSEE	Southern Piedmont	2-50%	>60"		>72"	<b>A</b>
HULETT	Southern Piedmont	2-15%	>60"		>72"	<b>A</b>
IREDELL	Southern Piedmont	0-15%	40 - 60"	SOFT	12 - 24"	<i>unsuitable</i>
KIRKSEY	Southern Piedmont	0 - 10%	40 - 60"	HARD	18 - 36"	<b>J</b>
LLOYD	Southern Piedmont	2-50%	> 60"		> 72"	<b>A</b>
LOUISA	Southern Piedmont	6-80%	10-20"	SOFT	>72"	<b>N</b>
LOUISBURG	Southern Piedmont	26 - 45%	> 60"		>72"	
MADISON	Southern Piedmont	2-60%	>60"		>72"	<b>A</b>

Soil Series See Suitability Codes and Installation Information	MLRA Major Land Resource Area	Slope % Ranges of the soil type	Depth to Bedrock (ranges)	Bedrock Hardne ss	Depth to Seasonal High H2O Table (inches)	Suitability Code and Installation Information
MASADA	Southern Piedmont	0-25%	>60"		>72"	<b>C</b>
MECKLENBURG	Southern Piedmont	2-25%	>60"		>72"	<b>J</b>
MOLENA	Southern Piedmont	0-35%	>60"		>72"	<b>A</b>
MUSELLA	Southern Piedmont	2-80%	14 - 20"	SOFT	>72"	<b>H</b>
NASON	Southern Piedmont	0-50%	40-60"	SOFT	>72"	<b>N</b>
ORANGE	Southern Piedmont	0 - 15%	40 - 60"	HARD	12 - 36"	<i>unsuitable</i>
PACOLET	Southern Piedmont	2-80%	>60"		>72"	<b>A</b>
PAGELAND	Southern Piedmont	0-15%	20-40"	SOFT	18-36"	<i>unsuitable</i>
POINDEXTER	Southern Piedmont	2 - 60"	40 - 60"	HARD	> 72"	<b>H</b>
RAWLINGS	Southern Piedmont	6-45%	20-40"	HARD	> 72"	<b>H</b>
RION	Southern Piedmont	2-60%	>60"		>72"	<b>A</b>
RIVERVIEW	Southern Piedmont	0-5%	>60"		36-60"	<b>C</b>
ROANOKE	Southern Piedmont	0-2%	>60"		0-12"	<i>unsuitable</i>
SAW	Southern Piedmont	2 - 45%	20 - 40"	HARD	> 72"	<b>H</b>
SEDFIELD	Southern Piedmont	0-10%	>60"		12-18"	<i>unsuitable</i>
SHELLBLUFF	Southern Piedmont	0-3%	>60"		36-60"	<b>C</b>
STARR	Southern Piedmont	0-8%	>60"		>72"	<b>C</b>
STATE	Southern Piedmont	0-10%	>60"		42 - 72"	<b>C</b>
SWEETAPPLE	Southern Piedmont	6-60%	24-50"	SOFT	>72"	<b>N</b>
TALLAPOOSA	Southern Piedmont	5-80%	10-20"	SOFT	>72"	<b>N</b>
TATUM	Southern Piedmont	0-50%	40-60"	SOFT	>72"	<b>N</b>
TOCCOA	Southern Piedmont	0-4%	>60"		30-60"	<b>C</b>
VANCE	Southern Piedmont	2-25%	>60"		>72"	<b>J</b>
WAKE	Southern Piedmont	2-45%	11 - 20"	HARD	>72"	<i>unsuitable</i>
WATEREE	Southern Piedmont	2-95%	20-40"	SOFT	>72"	<b>N</b>
WEDOWEE	Southern Piedmont	0-60%	>60"		>72"	<b>A</b>
WEHADKEE	Southern Piedmont	0-2%	>60"		0-12"	<i>unsuitable</i>
WICKHAM	Southern Piedmont	0-25%	>60"		>72"	<b>A</b>
WILKES	Southern Piedmont	2-60%	40 - 60"	HARD	>72"	<b>N</b>
WINNSBORO	Southern Piedmont	2 - 25%	40 - 60"	SOFT	> 72"	<b>J</b>
WORSHAM	Southern Piedmont	0-8%	>60"		0-12"	<i>unsuitable</i>
WYNOTT	Southern Piedmont	2-45%	20-40"	SOFT	>72"	<i>unsuitable</i>
ZION	Southern Piedmont	2-45%	20-40"	HARD	>72"	<i>unsuitable</i>
AILEY	Sand Hills	0-25%	>60"		48 - 72"	<b>A</b>
BIBB	Sand Hills	0-2%	>60"		0 - 8"	<i>unsuitable</i>
BIGBEE	Sand Hills	0-5%	>60"		20 - 40"	<b>C</b>
CHASTAIN	Sand Hills	0-2%	>60"		0-12"	<i>unsuitable</i>
CHEWACLA	Sand Hills	0-2%	>60"		+ 12" - 24"	<i>unsuitable</i>
CONGAREE	Sand Hills	0-4%	>60"		30 - 48"	<b>C</b>
COWARTS	Sand Hills	1 - 25%			40 - 60"	
DOGUE	Southern Coastal Plain	0-15%	>60"		18-36"	<i>unsuitable</i>

Soil Series See Suitability Codes and Installation Information	MLRA Major Land Resource Area	Slope % Ranges of the soil type	Depth to Bedrock (ranges)	Bedrock Hardne ss	Depth to Seasonal High H2O Table (inches)	Suitability Code and Installation Information
DOTHAN	Sand Hills	0 - 12%			36 - 60"	<b>U</b>
ESTO	Sand Hills	2-25%	>60"		>72"	<b>J</b>
EUNOLA	Sand Hills	0-6%	>60"		18-30"	<b>C</b>
EUSTIS	Sand Hills	0 - 30%	>60"		> 72"	<b>A</b>
FACEVILLE	Sand Hills	0-15%	>60"		>72"	<b>A</b>
FUQUAY	Sand Hills	0-10%	>60"		48 - 72"	<b>A</b>
GRADY	Sand Hills	0-2%	>60"		0-12"	<i>unsuitable</i>
GREENVILLE	Sand Hills	0 - 18%	>60"		>72"	<b>A</b>
IUKA	Sand Hills	0 - 2%	> 60"		12 - 36"	<b>C</b>
KINSTON	Sand Hills	0-2%	>60"		0-12"	<i>unsuitable</i>
LAKELAND	Sand Hills	0 - 85%	>60"		>72"	<b>A</b>
LEVY	Sand Hills	0-2%	>60"		+ 24" - 0"	<b>C or F</b>
LUCY	Sand Hills	0 - 45%	>60"		>72"	<b>A</b>
MASADA	Sand Hills	0-25%	>60"		>72"	<b>A</b>
NANKIN	Sand Hills	0-60%	>60"		40 - 60"	<b>J</b>
NORFOLK	Sand Hills	0-10%	>60"		48-72"	<b>A</b>
OCHLOCKONEE	Sand Hills	0 - 3%	>60"		36 - 60"	<b>C</b>
OCILLA	Sand Hills	0-10%	>60"		12-30"	<b>C</b>
ORANGEBURG	Sand Hills	0 - 25%	> 60"		> 72"	<b>A</b>
OSIER	Sand Hills	0 - 2%	> 60"		< 12"	<i>unsuitable</i>
PELHAM	Sand Hills	0-2%	>60"		0-12"	<b>C, or F</b>
PELION	Sand Hills	0-15%	>60"		12-30"	<b>C</b>
RED BAY	Sand Hills	0-15%	>60"		>72"	<b>A</b>
RIVERVIEW	Sand Hills	0-5%	>60"		36-60"	<b>C</b>
STILSON	Sand Hills	0-8%	>60"		30-36"	<b>C or S</b>
SUSQUEHANNA	Sand Hills	1-17%	>60"		>72"	<i>unsuitable</i>
TROUP	Sand Hills	0-40%	>60"		>72"	<b>A</b>
VAUCLUSE	Sand Hills	2 - 25%	>60"		> 72"	
WAGRAM	Sand Hills	0 -15%	>60"		> 72"	<b>A</b>
WAHEE	Sand Hills	0 - 4%	72"		12 - 18"	<b>C or J</b>
AILEY	Southern Coastal Plain	0-25%	>60"		48 - 72"	<b>A</b>
ALAPAHA	Southern Coastal Plain	0-3%	>60"		0-12"	<b>C</b>
ALBANY	Southern Coastal Plain	0-6%	>60"		18 - 30"	<b>C</b>
AMERICUS	Southern Coastal Plain	0-25%	>60"		>72"	<b>A</b>
ARDILLA	Southern Coastal Plain	0-5%	>60"		12-24"	<b>C</b>
ARUNDEL	Southern Coastal Plain	2-35%	20-40"	HARD	>72"	<i>unsuitable</i>
BAYBORO	Southern Coastal Plain	0-2%	>60"		0-12"	<i>unsuitable</i>
BETHERA	Southern Coastal Plain	0-2%	>60"		0-18"	<i>unsuitable</i>
BIBB	Southern Coastal Plain	0-2%	>60"		0 - 8"	<i>unsuitable</i>
BIGBEE	Southern Coastal Plain	0-5%	>60"		20 - 40"	<b>C</b>
BINNSVILLE	Southern Coastal Plain	1 - 17%	7 - 20"	SOFT	20"	<i>unsuitable</i>

Soil Series See Suitability Codes and Installation Information	MLRA Major Land Resource Area	Slope % Ranges of the soil type	Depth to Bedrock (ranges)	Bedrock Hardne ss	Depth to Seasonal High H2O Table (inches)	Suitability Code and Installation Information
BLADEN	Southern Coastal Plain	0-2%	>60"		0-12"	<b>C</b>
BLANEY	Southern Coastal Plain	0-25%	>60"		>72"	
BLANTON	Southern Coastal Plain	0-20%	>60"		48 - 72"	<b>A</b>
BLANTON ( <i>Moderately Wet</i> )	Southern Coastal Plain	0-20%	>60"		30 - 48"	<b>C, or S</b>
BONIFAY	Southern Coastal Plain	0-12%	>60"		48-60"	<b>A</b>
BONNEAU	Southern Coastal Plain	0-12%	> 60"		42 - 60"	<b>A</b>
BOSWELL	Southern Coastal Plain	1 - 17 %	> 60"		>72	<i>unsuitable</i>
BUNCOMBE	Southern Coastal Plain	0 - 6%			> 72"	<b>C</b>
CAHABA	Southern Coastal Plain	0-8%	>60"		>72	<b>A</b>
CARNEGIE	Southern Coastal Plain	2-12%	>60"		40 - 60"	<b>U</b>
CENTENARY	Southern Coastal Plain	0-5%	>60"		42 - 60"	<b>A</b>
CHASTAIN	Southern Coastal Plain	0-2%	>60"		0-12"	<i>unsuitable</i>
CHEWACLA	Southern Coastal Plain	0-2%	>60"		+ 12" - 24"	<i>unsuitable</i>
CHIPLEY	Southern Coastal Plain	0-8%	>60"		18 - 36"	<b>C</b>
CHISOLM	Southern Coastal Plain	0 - 10%	>60"		36 - 60"	
CLARENDON	Southern Coastal Plain	0-6%	>60"		24-36"	<b>C</b>
COWARTS	Southern Coastal Plain	1 - 25%			40 - 60"	<b>N</b>
COXVILLE	Southern Coastal Plain	0 - 2%	>60"		0 - 12"	<i>unsuitable</i>
DASHER	Southern Coastal Plain	0-1%	>60"		+ 12 to 12"	<i>unsuitable</i>
DOGUE	Southern Coastal Plain	0-15%	>60"		18-36"	<b>C</b>
DOTHAN	Southern Coastal Plain	0 - 12%			36 - 60"	<b>U</b>
DUNBAR	Southern Coastal Plain	0 - 2%			12 - 30"	<b>C, J</b>
DUPLIN	Southern Coastal Plain	0 - 7%	>60"		24 - 36"	<b>C, J</b>
ECHAW	Southern Coastal Plain	0-2%	>60"		30 - 60"	<b>C</b>
ELLABELLE	Southern Coastal Plain	0-2%	>60"		<6"	<i>unsuitable</i>
ESTO	Southern Coastal Plain	2-25%	>60"		>72	<b>J</b>
EULONIA	Southern Coastal Plain	0-6%	>60"		18 - 42"	<b>C, J</b>
EUSTIS	Southern Coastal Plain	0 - 30%	>60"		> 72"	<b>A</b>
EUTAW	Southern Coastal Plain	0 - 2%	>60"		6 - 18"	<i>unsuitable</i>
FACEVILLE	Southern Coastal Plain	0-15%	>60"		>72"	<b>A</b>
FLOMATON	Southern Coastal Plain	2 - 40%	> 60"		>72"	<b>A</b>
FOXWORTH	Southern Coastal Plain	0 - 25%	> 60"		40 - 72"	<b>A</b>
FREEMANVILLE	Southern Coastal Plain	0 - 12%	> 60"		40 - 60"	<b>U</b>
FUQUAY	Southern Coastal Plain	0-10%	>60"		48 - 72"	<b>A or U</b>
GOLDSBORO	Southern Coastal Plain	0 - 10%	> 60"		18 - 30"	<b>C</b>
GRADY	Southern Coastal Plain	0-2%	>60"		0-12"	<i>unsuitable</i>
GREENVILLE	Southern Coastal Plain	0 - 18%	>60"		>72"	<b>A</b>
GRITNEY	Southern Coastal Plain	0 - 15%	> 60"		18 - 36"	<b>C, or J</b>
HENDERSON	Southern Coastal Plain	2 - 20%	> 60"		> 72"	<i>unsuitable</i>
HEROD	Southern Coastal Plain	0-2%	>60		0-12"	<i>unsuitable</i>

Soil Series See Suitability Codes and Installation Information	MLRA Major Land Resource Area	Slope % Ranges of the soil type	Depth to Bedrock (ranges)	Bedrock Hardne ss	Depth to Seasonal High H2O Table (inches)	Suitability Code and Installation Information
HORNSVILLE	Southern Coastal Plain	0 - 8%	> 60"		30 - 42"	<b>C, or J</b>
IRVINGTON	Southern Coastal Plain	0 - 5%	> 60"		18 - 36"	<b>C</b>
IUKA	Southern Coastal Plain	0 - 2%	> 60"		12 - 36"	<b>C</b>
IZAGORA	Southern Coastal Plain	0 - 8%	>60"		24-36"	<b>C</b>
JOHNS	Southern Coastal Plain	0 - 2%	> 60"		12 - 36"	<b>C</b>
JOHNSTON	Southern Coastal Plain	0 - 2%	> 60"		0 - 12"	<i>unsuitable</i>
KERSHAW	Southern Coastal Plain	0 - 15%	> 60"		> 72"	
KINSTON	Southern Coastal Plain	0-2%	>60"		0-12"	<i>unsuitable</i>
KOLOMOKI	Southern Coastal Plain	0 - 5%	>60"		60 - 72"	<b>A</b>
KUREB	Southern Coastal Plain	0-20"	>60"		>72"	
LAKELAND	Southern Coastal Plain	0 - 85%	>60"		>72"	
LEAF	Southern Coastal Plain	0 - 2%	>60"		6 - 18"	<i>unsuitable</i>
LEEFIELD	Southern Coastal Plain	0 - 12%	>60"		18 - 30"	<b>C</b>
LEON	Southern Coastal Plain	0-5%	>60"		12 - 24"	<b>C</b>
LEON (HYDRIC)	Southern Coastal Plain	0 - 2%	>60"		0 - 6"	<i>unsuitable</i>
LOWNDES	Southern Coastal Plain	0 - 17%	> 60"		> 72"	<b>A</b>
LUCY	Southern Coastal Plain	0 - 45%	>60"		>72"	<b>A</b>
LYNCHBURG	Southern Coastal Plain	0-2%	>60"		6 - 18"	<b>C</b>
MARLBORO	Southern Coastal Plain	0 - 10%	>60"		48 - 72"	<b>A</b>
MASCOTTE	Southern Coastal Plain	0-2%	>60"		6 - 18"	<b>C</b>
MAXTON	Southern Coastal Plain	0 - 6%	>60"		60 - 72"	<b>A</b>
MEGGETT	Southern Coastal Plain	0-3%	>60"		0-12"	<b>C, or J</b>
MUCKALEE	Southern Coastal Plain	0 - 2%	>60"		0-12"	<i>unsuitable</i>
MYATT	Southern Coastal Plain	0 - 2%	> 60"		0 - 12"	<i>unsuitable</i>
NANKIN	Southern Coastal Plain	0-60%	>60"		40 - 60"	<b>J</b>
NOBOCO	Southern Coastal Plain	0 - 6%	> 60"		30 - 40"	<b>C or S</b>
NORFOLK	Southern Coastal Plain	0-10%	>60"		48-72"	<b>A</b>
OCHLOCKONEE	Southern Coastal Plain	0 - 3%	>60"		36 - 60"	<i>unsuitable</i>
OCILLA	Southern Coastal Plain	0 - 10%	>60"		12 - 30"	<b>C</b>
OGEECHEE	Southern Coastal Plain	0-2%	>60"		+ 12" - 12"	<i>unsuitable</i>
OKTIBBEHA	Southern Coastal Plain	1 - 30%	>60"		> 72"	<i>unsuitable</i>
OLUSTEE	Southern Coastal Plain	0 - 2%	> 60"		6 - 18"	<b>C</b>
ORANGEBURG	Southern Coastal Plain	0 - 25%	> 60"		> 72"	<b>A</b>
OSIER	Southern Coastal Plain	0 - 2%	> 60"		< 12"	<i>unsuitable</i>
OUSLEY	Southern Coastal Plain	0-5%	>60"		18 - 36"	<b>C</b>
PELHAM	Southern Coastal Plain	0-2%	>60"		+ 12" - 18"	<i>unsuitable</i>
PERSANTI	Southern Coastal Plain	0 - 6%	> 60"		18 - 36"	<i>unsuitable</i>
PICKNEY	Southern Coastal Plain	0-2%	> 60"		< 10" to 20"	<i>unsuitable</i>
PLUMMER	Southern Coastal Plain	0-5%	>60"		0-12"	<b>C</b>
RAINS	Southern Coastal Plain	0-2%	>60"		0-12"	<b>C</b>
RED BAY	Southern Coastal Plain	0-15%	>60"		>72"	<b>A</b>

Soil Series See Suitability Codes and Installation Information	MLRA Major Land Resource Area	Slope % Ranges of the soil type	Depth to Bedrock (ranges)	Bedrock Hardne ss	Depth to Seasonal High H <sub>2</sub> O Table (inches)	Suitability Code and Installation Information
REMBERT	Southern Coastal Plain	0-2%			0 - 12"	<i>unsuitable</i>
RIDGELAND	Southern Coastal Plain	0-2%	>60"		18-30"	<b>C</b>
RIGDON	Southern Coastal Plain	0 - 2%			18 - 30"	<b>C</b>
RUTLEGE	Southern Coastal Plain	0 - 2%	> 60"		0 - 6"	<i>unsuitable</i>
SHELLBLUFF	Southern Coastal Plain	0-3%	>72"		36 - 60"	<b>C</b>
STILSON	Southern Coastal Plain	0-8%	>60"		30-36"	<b>C or S</b>
SUFFOLK	Southern Coastal Plain	0 - 50%	>60"		> 72"	<b>A</b>
SUMTER	Southern Coastal Plain	1 - 40%				
SUNSWEET	Southern Coastal Plain	2-25%			40 - 60"	<b>J</b>
SURRENCY	Southern Coastal Plain	0 - 1%			0 - 6"	<i>unsuitable</i>
SUSQUEHANNA	Southern Coastal Plain	1-17%	>60"		>72"	<i>unsuitable</i>
TAWCAW	Southern Coastal Plain	0 - 2%	>72"		18 - 30"	<i>unsuitable</i>
TELFAIR	Southern Coastal Plain	2-15%	20-40"	<b>HARD</b>	12 - 36"	<i>unsuitable</i>
TIFTON	Southern Coastal Plain	0 - 8%	>72"		40 - 60"	<b>A or U</b>
TORHUNTA	Southern Coastal Plain	0 - 2%	>60"		6 - 18"	<b>C</b>
TROUP	Southern Coastal Plain	0-40%	>60"		>72"	<b>A</b>
VALDOSTA	Southern Coastal Plain	0 - 5 %	>60"		>72"	<b>A</b>
VARINA	Southern Coastal Plain	0-10%	>60"		48 - 60"	<b>A or U</b>
VAUCLUSE	Southern Coastal Plain	2 - 25%	>60"		> 72"	
WAGRAM	Southern Coastal Plain	0 -15%	>60		> 72"	<b>A</b>
WAHEE	Southern Coastal Plain	0 - 4%	72"		12 - 18"	<b>C, or J</b>
WEHADKEE	Southern Coastal Plain	0 - 2%	> 60		0 - 12"	<i>unsuitable</i>
WICKSBURG	Southern Coastal Plain	0-12%	>60		40 - 60"	<b>A or U</b>
AILEY	Atlantic Coastal Plain	0 - 25%	> 60"		48 - 72"	<b>A</b>
ALBANY	Atlantic Coastal Plain	0 - 6%	>72"		18 - 30"	<b>C</b>
ALLANTON	Atlantic Coastal Plain		>60		0 - 6"	<i>unsuitable</i>
ARDILLA	Atlantic Coastal Plain	0 - 5%			12 - 24"	<b>C</b>
BAYBORO	Atlantic Coastal Plain	0 - 2%	>60"		0 - 12"	<i>unsuitable</i>
BETHERA	Atlantic Coastal Plain	0 - 2%	>60"		0 - 18"	<i>unsuitable</i>
BIBB	Atlantic Coastal Plain	0 - 1%	>72"		.5 - 1"	<i>unsuitable</i>
BLADEN	Atlantic Coastal Plain	0 - 2%	>72"		0 - 12"	<i>unsuitable</i>
BLANTON	Atlantic Coastal Plain	0 - 45%	>72"		30 - 72"	<b>A</b>
BOHICKET	Atlantic Coastal Plain	0 - 2%	> 60"			<i>unsuitable</i>
BONIFAY	Atlantic Coastal Plain	0 - 12%	>72"		40 - 60"	<b>A</b>
BROOKMAN	Atlantic Coastal Plain	0 - 2%	> 60"	>72"	0 - 12"	<i>unsuitable</i>
CAINHOY	Atlantic Coastal Plain	0 - 10%	> 60"		40 - 60"	<b>A</b>
CAPE FEAR	Atlantic Coastal Plain	0 - 2%	> 60"		0 - 12"	<i>unsuitable</i>
CAPERS	Atlantic Coastal Plain	0 - 2%	> 60"		+ 12" - 12"	<i>unsuitable</i>
CARNEGIE	Atlantic Coastal Plain	2 - 12%			40 - 60"	<b>U</b>
CENTENARY	Atlantic Coastal Plain	0-5%			42 - 60"	<b>A</b>
CHASTAIN	Atlantic Coastal Plain	0 - 2%			0 - 12"	<i>unsuitable</i>

Soil Series See Suitability Codes and Installation Information	MLRA Major Land Resource Area	Slope % Ranges of the soil type	Depth to Bedrock (ranges)	Bedrock Hardne ss	Depth to Seasonal High H <sub>2</sub> O Table (inches)	Suitability Code and Installation Information
CHIPLEY	Atlantic Coastal Plain	0 - 8%			18 - 36"	<b>C</b>
CLARENDON	Atlantic Coastal Plain	0 - 6%			24 - 36"	<b>C</b>
COWARTS	Atlantic Coastal Plain	1 - 25%			40 - 60"	<b>N</b>
COXVILLE	Atlantic Coastal Plain	0 - 2%	>72"		0 - 12"	<i>unsuitable</i>
CRAVEN	Atlantic Coastal Plain	0 - 12%	> 60"		24 - 36"	<b>C</b>
CROATAN	Atlantic Coastal Plain				0 - 12"	<i>unsuitable</i>
DASHER	Atlantic Coastal Plain	0 - 1%			+ 12" - 12"	<i>unsuitable</i>
DOTHAN	Atlantic Coastal Plain	0 - 12%			36 - 60"	<b>U</b>
DUCKSTON	Atlantic Coastal Plain	0 - 2%	> 60"		0 - 6"	<i>unsuitable</i>
DUNBAR	Atlantic Coastal Plain	0 - 2%	> 60"		12 - 24"	<b>C</b>
ECHAW	Atlantic Coastal Plain	0 - 2%			30 - 60"	<b>C</b>
ELLABELLE	Atlantic Coastal Plain	0 - 2%			+ 12" - 6"	<i>unsuitable</i>
EULONIA	Atlantic Coastal Plain	0 - 6%			18 - 42"	<b>C</b>
FOXWORTH	Atlantic Coastal Plain	0 - 25%			40 - 60"	<b>A</b>
FRIPP	Atlantic Coastal Plain	2 - 30%	> 60"		> 72"	<i>unsuitable</i>
FUQUAY	Atlantic Coastal Plain	0 - 10%	> 60"		48- 72"	<b>A or U</b>
GRADY	Atlantic Coastal Plain	0 - 2%			+ 24" - 12"	<i>unsuitable</i>
HAZLEHURST	Atlantic Coastal Plain	0 - 3%	> 60"		6 - 24"	<b>C</b>
HURRICANE	Atlantic Coastal Plain	0 - 5%	> 60"		24 - 42"	<b>C</b>
JOHNSTON	Atlantic Coastal Plain	0 - 2%			0 - 12"	<i>unsuitable</i>
KERSHAW	Atlantic Coastal Plain	2 - 15%			>72"	
KINGSFERRY	Atlantic Coastal Plain	0 - 2%	> 60"		0 - 6"	<i>unsuitable</i>
KINGSLAND	Atlantic Coastal Plain	0 - 1%	> 60"		+ 2' - 6"	<i>unsuitable</i>
KINSTON	Atlantic Coastal Plain	0 - 2%	> 60"		0 - 12"	<i>unsuitable</i>
KUREB	Atlantic Coastal Plain	0 - 20%			>72"	
LAKELAND	Atlantic Coastal Plain	0 - 85%			>72"	
LEEFIELD	Atlantic Coastal Plain	0 - 12"			18 - 30"	<b>C</b>
LEON	Atlantic Coastal Plain	0 - 5%			0 - 6" or deeper	<b>C</b>
LEVY	Atlantic Coastal Plain	0 - 2%	> 60"		+ 2' to 0"	<i>unsuitable</i>
LOWNDES	Atlantic Coastal Plain	0 - 17%			> 48"	<b>A</b>
LUCY	Atlantic Coastal Plain	0 - 45%			40 - 60"	<b>A</b>
LUMBEE	Atlantic Coastal Plain	0 - 2%	> 60"		0 - 12"	<i>unsuitable</i>
LYNN HAVEN	Atlantic Coastal Plain	0 - 5%	> 60"		0 - 6"	<i>unsuitable</i>
MANDARIN	Atlantic Coastal Plain	0 - 3%	> 60"		18 - 36"	<b>C</b>
MASCOTTE	Atlantic Coastal Plain	0 - 2%			6 - 18"	<b>C</b>
MEGGETT	Atlantic Coastal Plain	0 - 3%	>60"		0 - 12"	<i>unsuitable</i>
NANKIN	Atlantic Coastal Plain	0 - 60%	>72"		40 - 60"	<b>J</b>
NOBOCO	Atlantic Coastal Plain	0 - 6%	> 60"		30 - 40"	<b>C or S</b>
OCILLA	Atlantic Coastal Plain	0 - 10%			12 - 30"	<b>C</b>
OGEECHEE	Atlantic Coastal Plain	0 - 2%			+ 1' to 12"	<i>unsuitable</i>

Soil Series See Suitability Codes and Installation Information	MLRA Major Land Resource Area	Slope % Ranges of the soil type	Depth to Bedrock (ranges)	Bedrock Hardne ss	Depth to Seasonal High H <sub>2</sub> O Table (inches)	Suitability Code and Installation Information
OLUSTEE	Atlantic Coastal Plain	0 - 2%	> 80"		6 - 18"	<b>C</b>
OSIER	Atlantic Coastal Plain	0 - 2%	> 60"		< 12"	<i>unsuitable</i>
OUSLEY	Atlantic Coastal Plain	0 - 5%	> 60"		18 - 36"	<i>unsuitable</i>
PELHAM	Atlantic Coastal Plain	0 - 5%			+ 1' to 18"	<i>unsuitable</i>
PICKNEY	Atlantic Coastal Plain	0 - 2%			< 10" to 20"	<i>unsuitable</i>
PLUMMER	Atlantic Coastal Plain	0 - 5%			0 - 12"	<i>unsuitable</i>
PONZER	Atlantic Coastal Plain	0 - 2%	> 60"		0 - 12"	<i>unsuitable</i>
POOLER	Atlantic Coastal Plain	0 - 2%	> 60"		0 - 12"	<b>C, or J</b>
POTTSBURG	Atlantic Coastal Plain	0 - 2%	> 60"		0 - 24"	<b>C</b>
RAINS	Atlantic Coastal Plain	0 - 2%			0 - 12"	<i>unsuitable</i>
RICEBORO	Atlantic Coastal Plain	0 - 2%	> 60"		0 - 12"	<b>C, or J</b>
RIDGELAND	Atlantic Coastal Plain	0 - 2%	> 60"		18 - 30"	<b>C</b>
RIGDON	Atlantic Coastal Plain	0 - 2%	> 60"		18 - 30"	<b>C</b>
RIMINI	Atlantic Coastal Plain	0 - 10%	> 60"		> 72"	
RUTLEGE	Atlantic Coastal Plain	0 - 2%			0 - 6"	<i>unsuitable</i>
SAPELO	Atlantic Coastal Plain	0 - 2%			0 - 18"	<b>C</b>
SATILLA	Atlantic Coastal Plain	0 - 1%			0 - 18"	<i>unsuitable</i>
SCRANTON	Atlantic Coastal Plain	0 - 2%			6 - 18"	<b>C</b>
STILSON	Atlantic Coastal Plain	0 - 5%	>72"		30 - 40"	<b>C or S</b>
SUNSWEEP	Atlantic Coastal Plain	2 - 25%	> 72"		40 - 60"	<b>J</b>
SURRENCY	Atlantic Coastal Plain	0 - 1%	>72"		0 to 0.5"	<i>unsuitable</i>
TAWCAW	Atlantic Coastal Plain	0 - 2%	>72"		18 - 30"	<i>unsuitable</i>
TELFAIR	Atlantic Coastal Plain	2 - 15%	20 - 40"		12 - 36"	<i>unsuitable</i>
TIFTON	Atlantic Coastal Plain	0 - 8%	>72"		40 - 60"	<b>U</b>
TROUP	Atlantic Coastal Plain	0 - 40%	>72"			<b>A</b>
VALDOSTA	Atlantic Coastal Plain	0 - 5%	>72"		>60"	<b>A</b>
WAHEE	Atlantic Coastal Plain	0 - 4%	72"		12 - 18"	<b>C, or J</b>
WICKSBURG	Atlantic Coastal Plain	0 - 12%	72"		40 - 60"	<b>A</b>

**Table 3.C Soil Texture**

<b>Soil Class</b>	<b>Dry Soil</b>	<b>Moist Soil</b>
Sand	Loose single grains, which feel gritty and can be seen with the naked eye. Squeezed in the hand the soil mass falls apart when pressure is released.	Squeezed in the hand it forms a cast, which crumbles when touched. Does not form a ribbon. Very gritty.
Sandy Loam	Aggregates are easily crushed; very faint velvety feeling initially but as rubbing is continued the gritty feeling of sand soon dominates.	Feels gritty, forms a cast, which bears careful handling without breaking. Doesn't form a ribbon, will compact when squeezed between thumb and forefinger.
Loam	Aggregates are crushed under moderate pressure; clods can be quite firm. When pulverized loam has a velvety feel that becomes gritty with continued rubbing. Casts bear careful handling.	Cast can be freely handled without breaking. Slight tendency to ribbon. Rubbed surface is rough, slightly gritty.
Silt Loam	Aggregates are firm but may be crushed under moderate pressure. Clods are firm to hard. Smooth, flour like feel dominates when soil is pulverized.	Cast can be freely handled without breaking. Slight tendency to ribbon with rubbed surface having a broken or rippled appearance.
Clay Loam	Very firm aggregates and hard clods that strongly resist crushing by hand. When pulverized the soil takes a somewhat gritty feeling due to the harshness of the very small aggregates which persist.	Cast can bear much handling without breaking. Pinched between thumb and forefinger it forms a ribbon whose surface tends to feel gritty when dampened and rubbed. Ribbon will break easily; barely sustaining its own weight. Will slick (shine) when rubbed. Soil is plastic, sticky and puddles easily.
Clay	Aggregates are hard and clods are extremely hard which strongly resist crushing by hand. When pulverized it has a gritty texture due to harshness of numerous very small aggregates, which persist.	Casts can bear considerable handling without breaking. Forms a long flexible ribbon and retains its plasticity when elongated. Rubbed surface has a very smooth, satin feeling, sticky when wet and easily puddle.

Figure 2.C Georgia Major Land Resource Areas (MLRA's)

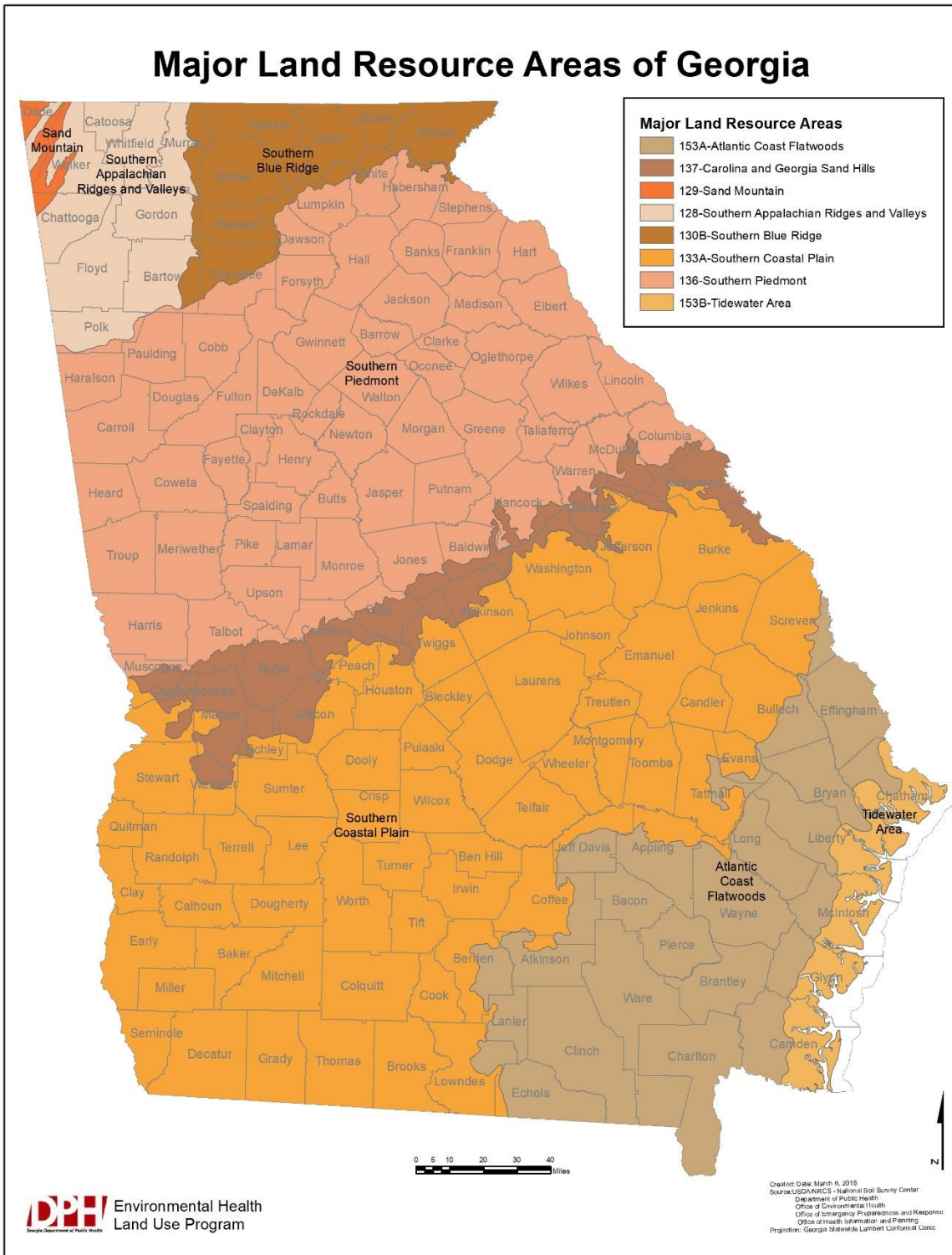
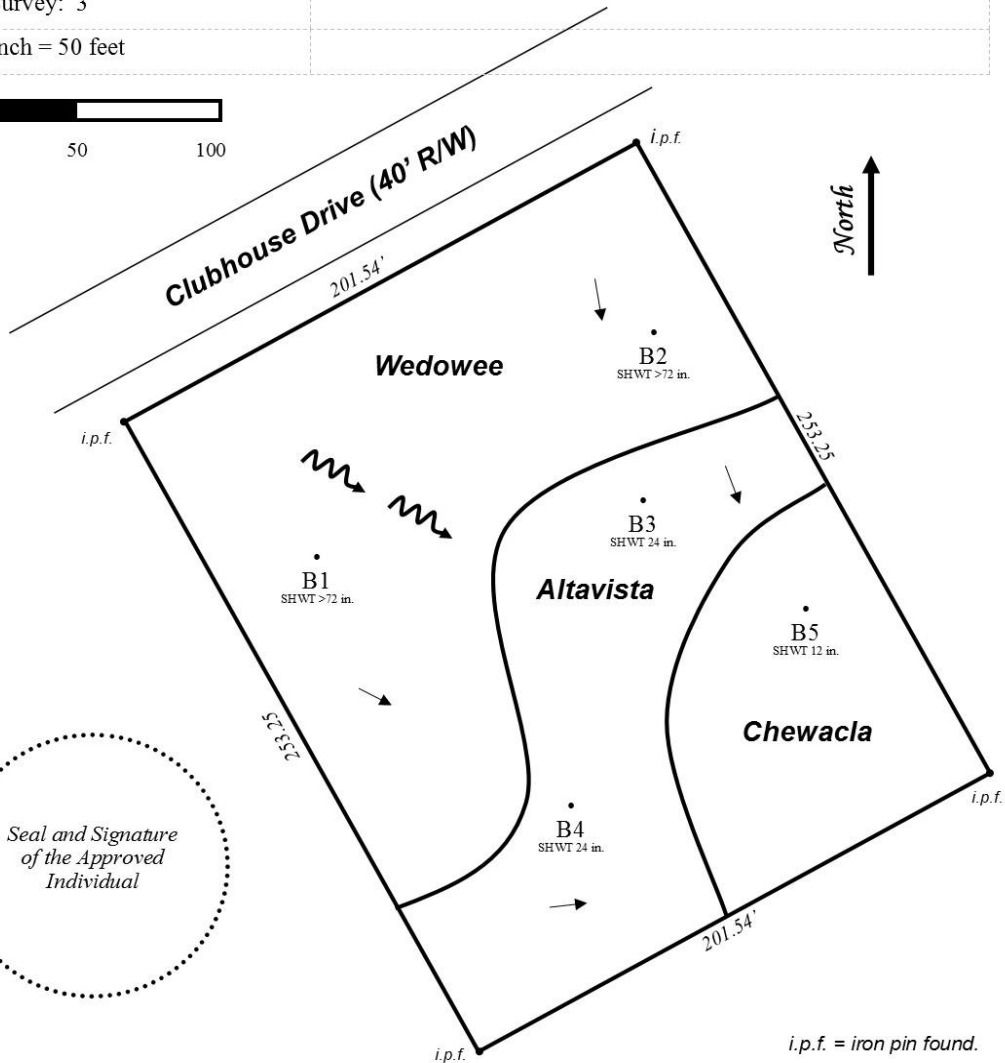

Figure 3.C Example Soil Report: Page 1 of 2

Soil Crisis Center, Inc.  
 123 Evard Street  
 Lakeland, GA 30253  
 (404) 123-4567

Date: 05/02/2016	<p style="text-align: center;"><u>Legend</u></p> <p>Well: ⊕</p> <p>Slope: ↗</p> <p>Boring: B1</p> <p>Rock outcrop: ΔΔ</p> <p>Stream: - - - - -</p> <p>Gully: ~~~~~</p>
Site Location: 505 Clubhouse Drive	
Subdivision: Beautiful Acres, lot 7	
Property Owner: Joe Developer	
Phone: (404) 657-6534	
Level of Survey: 3	
Scale: 1 inch = 50 feet	



Seal and Signature  
 of the Approved  
 Individual

*i.p.f.* = iron pin found.

**Figure 4.C Example Soil Report: Page 2 of 2**

Soil Crisis Center, Inc.  
123 Evard Street  
Lakeland, GA 30253  
(404) 123-4567

Property Information	
Date: 05/02/2016	Level of Survey: 3
Site Location: 505 Clubhouse Drive	Property Owner: Joe Developer
Subdivision: Beautiful Acres, lot 7	Phone: (404) 657-6534
County: Susquehanna	Scale: 1 inch = 50 feet

Map Unit Properties						
Soil Series	Slope %	Depth to Bedrock	Depth to Seasonal High Water Table	Absorption Rate at Recommended Trench Depth	Recommended Trench Depth	Map Unit Suitability Code
Wedowee	5-15 %	>72 in.	>72 in.	45 min. / in.	24-36 in.	A
Altavista	5-10 %	>72 in.	24 in.	See codes	See codes	C
Chewacla	0-2 %	>72 in.	12 in.	Not Recommended	Not Recommended	F

Map Unit Suitability Codes	
A	These soils are suitable for installation of on-site systems with proper system design, installation, and maintenance. Position of the site or other soil and landscape considerations may require the drain field area to be greater than the minimum and/or the drain field design to require equal distribution or level field installation.
C	Because of flooding, shallow seasonal water tables, soil horizons with very slow percolation rate, perched water tables, or imperfect drainage, these soils are not suitable for installation of a conventional on-site system without site modifications, special designs or installation. Properties of the soil and site may require the drain field area to be greater than the minimum and/or the drainfield design to require equal distribution or level field installation. Non-conventional systems and installation must be approved by the local Environmental Health Specialist.
F	Because of soil limitations, these soils are unsuitable for installation of an on-site system.

General Notes
Boring locations illustrated on the soil map were located from the existing corner pins using a hip chain and compass. Base map is from final property plat surveyed by Generic Surveyors, Inc. dated 04/02/16. Survey was provided by owner.

**Form 1.C Soil Data Record - Percolation, Water Table, and Soil Data**

<b>GEORGIA DEPARTMENT OF PUBLIC HEALTH</b>					
<b>Soil Data Record - Percolation, Water Table, and Soil Data</b>					
Name of Proposed Development:					
Location of Proposed Development:					
County:					
Land Lot:					
Land District:					
Owner or Sponsor:					
Phone Number:					
Owner or Sponsor Address:					
Percolation Data					
Test Hole Number					
Hole Depth and					
Percolation Rate (minutes/inch)					
Types of Subsoil Encountered					
Test Hole Number					
Hole Depth and					
Percolation Rate (minutes/inch)					
Types of Subsoil Encountered					
1			11		
2			12		
3			13		
4			14		
5			15		
6			16		
7			17		
8			18		
9			19		
10			20		
<ul style="list-style-type: none"> <li>➤ If it appears that the ground water table may adversely affect the operation of on-site sewage management systems at any time of the year, specify by lot numbers and indicate on a topographic map the areas so affected:</li> <li>➤ If rock, shale, hardpan or similar formations occur as outcroppings or within a six-foot depth on any of the lots in this physical development, specify by lot numbers and indicate on a topographic map the areas so affected:</li> </ul>					
Boring Number			Soil Descriptions*		
1					
2					
3					
4					
5					
6					

7	
8	
9	
10	
*Note: Soil descriptions must include color, texture, structure, consistence, and redoximorphic features. All borings must be located on a topographic map. Attach additional sheets as necessary.	

**Form 2.C Soil Survey Report Check List**

GEORGIA DEPARTMENT OF PUBLIC HEALTH Level 3 Soil Survey Report Check List		
✓ = Complete      x = Incomplete		
<b><i>Soil Survey Report:</i></b>		
	Soil survey boundaries mapped at a scale within a range of one-inch equals ten feet to one-inch equals one hundred feet; a bar scale must be included.	
	Clear identification of mapping: intensity, scale, and symbols (plus a North arrow).	
	Caption identifying the project or client name, location of the project and county, contact number, and date of survey.	
	Name, address, phone number, and stamp or seal of the Certified Soil Classifier.	
	Level 3 subdivision reports on a site-specific two-foot contour interval topo map.	
<b><i>Soil Properties Table, Interpretations, and Suitability Code (s):</i></b>		
	Name of map unit (soil series, no symbols)	Verified seasonal high water table within 72 inches of the surface
	Suitability code (custom or Table 1.C)	Absorption rate and depth of occurrence (upper and lower limits of horizon).
	Percent slope	Depth to refusal/restrictive layer
<b><i>Field Evaluations:</i></b>		
	A minimum of at least one hole bored and classified per 0.25 acres. For any site less than one acre in size, four borings are the minimum requirement.	
	All borings numbered, flagged, and illustrated with their corresponding number on the finished soil map within 15 feet of the true boring location.	
	All borings to a minimum of 72 inches, unless a refusal layer is identified or to not less than 24 inches beneath the planned absorption trench bottom.	
	All reference points numbered and identified on-site.	
*Reports not including the required information should be returned to the Classifier. Notification of deficient reports shall be provided in writing by mail within 3 business days		

Comments:

DPH Representative:

Date:

## Form 3.C OSSMS Construction Permit (page 1)

**GEORGIA DEPARTMENT OF PUBLIC HEALTH  
CONSTRUCTION PERMIT AND SITE APPROVAL  
For On-Site Sewage Management System**

COUNTY	SUBDIVISION	LOT NUMBER	BLOCK
PROPERTY LOCATION (ADDRESS/DIRECTIONS)			
I hereby apply for a construction permit to install an On-Site Sewage Management System and agree that the system will be installed to conform to the requirements of the rules of the Georgia Department of Public Health, Chapter 511-3-1. By my signature, I understand that final inspection is required and will notify the County Health Department upon completion of construction and before applying final cover material to the system.			
PROPERTY OWNER'S/AUTHORIZED AGENT'S SIGNATURE		DATE	
PROPERTY OWNER'S NAME	PHONE NUMBER	ALTERNATE PHONE NUMBER	
PROPERTY OWNER'S ADDRESS			
AUTHORIZED AGENT'S NAME (if other than owner)	PHONE NUMBER	RELATIONSHIP TO OWNER	
<b>Section A — General Information</b>			
1. REQUIRED SETBACK FROM RECEIVING BODIES EVALUATED (wells, lakes, sinkholes, streams, etc.) (1) YES (2) NO		9. SOIL SERIES (e.g. Picolet, Orangeburg, etc.)	
2. WATER SUPPLY (1) PUBLIC (2) PRIVATE (3) COMMUNITY		10. PERCOLATION RATE / HYDRAULIC LOADING RATE	
3. SEWAGE SYSTEM TO BE PERMITTED (1) NEW (2) REPAIR (3) ADDITION		11. RESTRICTIVE SOIL HORIZON DEPTH (inches)	
4. LOT SIZE (SQUARE FEET / ACRES)		12. SOIL TEST PERFORMED BY	
5. TYPE OF STRUCTURE (single/multi-family residence, commercial, restaurant, etc.)			
6. WATER USAGE BY		7. NO. OF BEDROOMS / GFD	
8. LEVEL OF PLUMBING OUTLET (1) GROUND LEVEL (2) BASEMENT (3) ABOVE GROUND LEVEL			
<b>Section B — Primary / Pretreatment</b>			
1. DISPOSAL METHOD	2. GARBAGE DISPOSAL (1) YES (2) NO	3. SEPTIC TANK CAPACITY (gallons)	4. ATU CAPACITY
		5. DOSING TANK CAPACITY (gallons)	6. GREASE TRAP CAPACITY (gallons)
<b>Section C — Secondary Treatment</b>			
1. ABSORPTION FIELD DESIGN (1) Level Field (2) Serial (3) Drip (4) Bed (5) Distribution Box (6) Mound/Area Fill (7) Other		4. TOTAL ABSORPTION FIELD SQUARE FEET REQUIRED	
2. ABSORPTION FIELD PRODUCT		5. TOTAL ABSORPTION FIELD LINEAR FEET REQUIRED	
3. AGGREGATE DEPTH (inches)		6. DEPTH OF ABSORPTION TRENCHES (range in inches)	
		7. NUMBER OF ABSORPTION TRENCHES	
		8. SPECIFIED LENGTH OF ABSORPTION TRENCHES	
		9. DISTANCE BETWEEN ABSORPTION TRENCHES	
<b>PERMIT</b>			
A permit is hereby granted to install the on-site sewage management system described above. This permit is not valid unless properly signed below. This permit expires twelve (12) months from date of issuance.			
Any grading, filling, or other landscaping subsequent to issuance of a permit may render permit void, failure to follow site plan may render permit void. Any grading, filling, or other landscaping subsequent to final inspection by county health department, which adversely affects the function of the on-site sewage management system, may render approval void. Installation contractor is responsible for locating proper distances from buildings, wells, property lines, etc.			
Issuance of a construction permit for an on-site sewage management system, and subsequent approval of same by representative of the Georgia Department of Public Health or county board of health shall not be construed as a guarantee that such systems will function satisfactorily for a given period of time; furthermore, said representative(s) do not, by any action taken in effecting compliance with these rules, assume any liability for damages which are caused, or which may be caused, by the malfunction of such system.			
APPROVING ENVIRONMENTALIST / TITLE		DATE	CONSTRUCTION PERMIT NUMBER
			SITE APPROVED AS SPECIFIED ABOVE (1) YES (2) NO

**Form 4.C OSSMS Construction Permit (page 2)**

GEORGIA DEPARTMENT OF PUBLIC HEALTH  
CONSTRUCTION PERMIT AND SITE APPROVAL For On-Site Sewage  
Management System  
County  
County Phone  
Permit Number  
Property Address

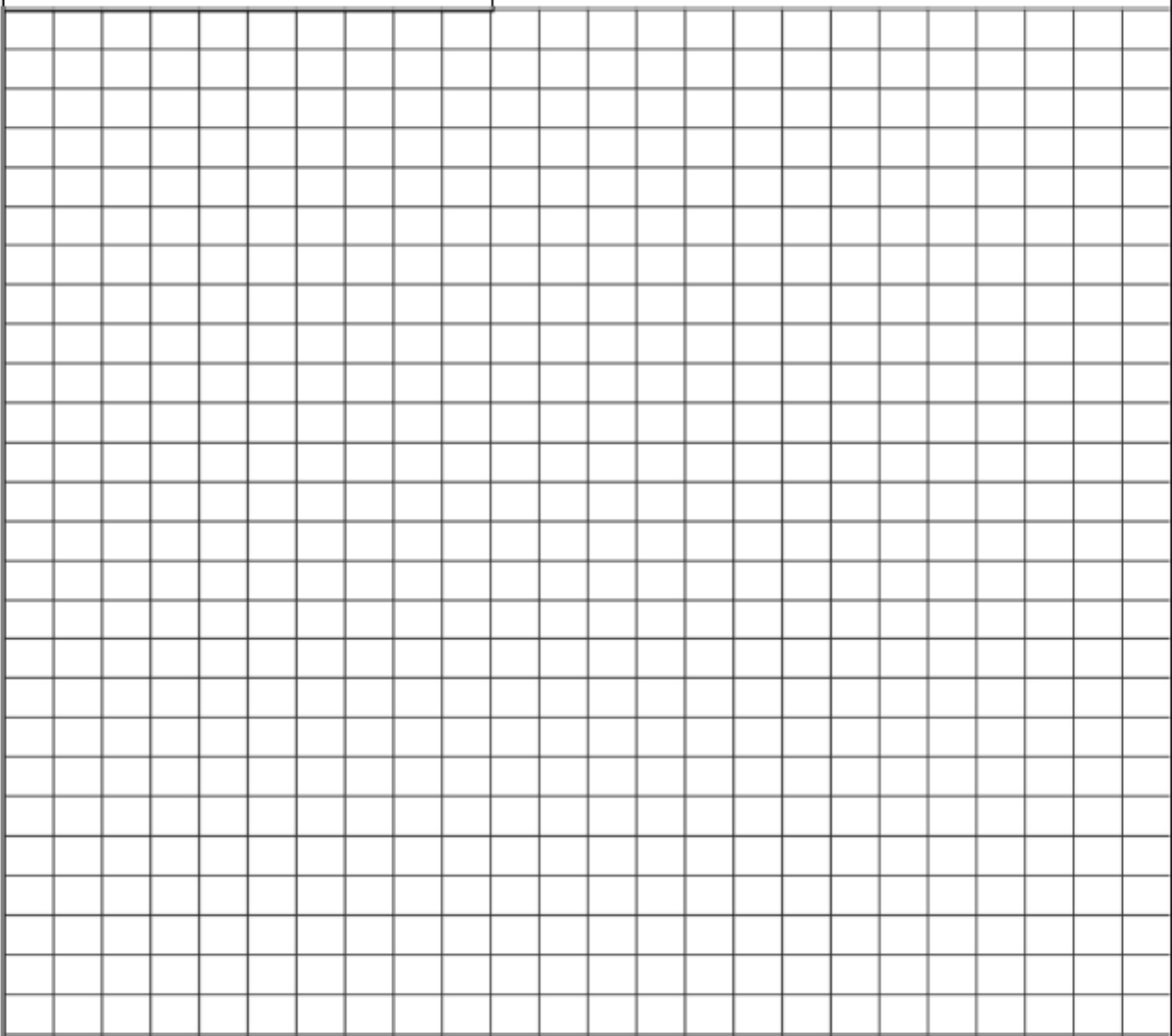
PRESCRIBED TANK LOCATION / REMARKS	
PRESCRIBED ABSORPTION FIELD LOCATION	
PROPOSED SYSTEM LAYOUT/DESIGN	
	

## Form 5.C OSSMS Site Evaluation Request Form

<b>ON-SITE SEWAGE MANAGEMENT SYSTEM SITE EVALUATION REQUEST</b>				
Division of Health Protection / Environmental Health / Land Use Program				
<p>Instructions: The applicant or authorized agent should provide as much information as possible on this form. The local board of health will issue OSSMS construction permits based on minimum standards after an assessment of site conditions, soil characteristics, and proposed daily wastewater flow. As a minimum, a site plan sketch; proposed daily flow (or number of bedrooms); and permission to visit the site must be provided. <i>Note: Where system components are not indicated by the applicant, the local board of health will permit minimum conventional system standards based on wastewater flow, soil characteristics, and site conditions.</i></p>				
GENERAL INFORMATION				
County:		Subdivision:		Lot:
Street Address/City/Zip:				
<b>Request Type:</b>	<b>Stub Out Location:</b>	<b>Water Supply:</b>	<b>Type of Facility:</b>	<b>Number of Bedrooms or gpd:</b>
1. New	1. Slab	1. Public	1. Residential	<b>Garbage Disposal: Yes / No</b>
2. Repair	2. Crawl-Space	2. Private Well	2. Non-Residential	<b>Lot Size:</b>
3. Addition	3. Basement	3. Community Well		<b>Drainfield Type:</b>
4. Relocation	4. Other			
PROPOSED SITE PLAN SKETCH				
<p>The following information must be provided in the space below: 1) lot sketch showing lot dimensions, proposed building location/dimensions, proposed building line and side line distances; 2) street or road name; 3) well location if applicable and well locations on adjacent property; 4) driveway, patio or other paved surfaces; 5) underground utilities; 6) plumbing stub out and proposed drainfield location; 7) location of easements and flood plain; 8) replacement area, if necessary. <i>Note: Complex lots, commercial systems, or alternative systems may require accurately scaled site plans and/or engineered design plans.</i></p>				
<p>The above information as furnished is true and correct to the best of my knowledge. I hereby apply for an on-site sewage management system construction permit and inspection of that system based upon this information. I do hereby give permission to the health department to enter onto the property, at reasonable hours, for the purpose of processing this application. The applicant and/or owner is responsible for adverse soil conditions, such as rock or water tables, encountered.</p>				
Signature of Applicant:			Date of Application:	
Applicant Name (print):		Applicant Address:		Phone:
Owner Name (print):		Owner Address:		Phone:
DEPARTMENT USE ONLY				
Fee Amount Paid:		Received By:		Date:
Date of Evaluation:		EHS:		Approved:
<p>*Note: The local board of health will approve the construction of any equivalent system components that have been approved for use in the state of Georgia by the Department of Public Health under the condition the installation is performed in accordance with the Rules of the Department of Public Health, Chapter 511-3-1; the Georgia Manual for On-Site Sewage Systems; and current TRC product approvals. The grant of a permit by the county board of health for the installation of any on-site sewage management system does not constitute a warranty or endorsement.</p>				

**Form 6.C Lot Evaluation Record**

<b>LOT EVALUATION RECORD</b>				
Division of Health Protection / Environmental Health / Land Use Program				
General Information				
County:	Subdivision:	Lot:		
Street Address:				
Boring Number	Estimated Percolation Rate	Depth to Estimated Percolation Rate	Depth to Seasonal High-Water Table	Depth to Refusal or Restrictive Layer
<small>*Note: Sites with poor percolation, redoximorphic features or restrictive layers within 24 inches of the planned absorption trench bottom, a seasonal high-water table within 30 inches of the original ground surface or other questionable soil features will require evaluation from an approved professional.</small>				
Sketch Identifying Boring Locations				
<div style="border: 1px solid gray; width: 100%; height: 100%; background-color: #f0f0f0;"> <!-- Grid for sketching --> </div>				
Comments and Recommendations				
<div style="border: 1px solid gray; width: 100%; height: 100%; background-color: #f0f0f0;"> <!-- Area for comments --> </div>				
Evaluated By:			Date of Evaluation:	



# Manual for On-Site Sewage Management Systems

## SECTION D | PRETREATMENT

Environmental Health Section

---

## SECTION D - PRETREATMENT

### 1) Preface

An on-site sewage pretreatment unit means a watertight sewage treatment structure designed and constructed to receive raw sewage, separate solids from liquids, digest organic matter through a period of retention and allow clarified effluent to discharge to a subsurface soil absorption system. Such pretreatment units fall into three basic categories:

- A. *Septic Tanks* -- which rely predominantly on anaerobic bacterial action for treatment;
- B. *Aerobic Treatment Units (ATU's)* -- which introduce atmospheric air into the sewage to promote treatment by aerobic bacteria; and
- C. *Combination Units* -- which provide treatment through anaerobic and aerobic bacterial action and/or mechanical filtering, ozonation or ultraviolet irradiation.

### 2) Septic Tank Pretreatment Units

The primary purpose of the septic tank is to remove solids suspended in the wastewater. It is to provide quiescent conditions for a sufficient period of time to allow the settleable solids to fall to the bottom and the scum to rise to the top. The sludge (accumulated solids) and scum collect in the septic tank for a few years (usually 3-5 years) without disturbing the sedimentation function.

Anaerobic biological reduction of the sludge is a beneficial result of prolonged storage of solids in the tank. The bacteria in the tank deplete any oxygen that may be dissolved in the waste while feeding on the concentrated organics. In the anaerobic environment, facultative and anaerobic bacteria attack the organic molecules reducing them to soluble compounds and gases. The digestion has several effects on tank performance:

- A. The sludge volume can be reduced up to 40 percent, reducing the septage pumping frequency;
- B. The rising gas bubbles from the sludge blanket may carry active organisms with them, seeding the clear liquid space of the tank to speed decomposition of the solids, which remain suspended in the liquid;
- C. The rising bubbles may interfere with effective settling and, thereby, carry suspended solids out of the tank; and
- D. A toxic and explosive atmosphere may result from the accumulation of the gases produced in the tank. These toxic gases can be fatal to septage pumpers; and for this reason, no one is advised to enter a septic tank without appropriate personal protective equipment.

### 3) Precast Concrete Septic Tanks

- A. *Liquid Depth* - The minimum requirement for the liquid depth is 36 inches.
- B. *Freeboard* - A minimum of nine inches freeboard is required, the freeboard being the air space between the top of the liquid and the bottom side of the lid or cap of the tank.

- 
- C. *Length and Width* - The length of the septic tank shall be at least one and one half (1½) times the tank width.
- D. *Inlet/Outlet Openings* - There may be a maximum of three-inlet opening knockouts in the tank: one opening or knockout shall be on the tank inlet end; knockouts on sidewalls of the inlet end are optional. Any knockout (s) shall leave a minimum concrete thickness of one inch in the tank wall. They shall accommodate a minimum of four inch or a maximum of six-inch pipe. No knockouts or openings shall be permitted below the tank liquid level. Any inlet opening or knockout shall be positioned such that at least a one (1) inch clearance will exist between the top of any inlet tee and the bottom surface of the tank top or access opening insert. Both the inlet and outlet openings may have seals cast into the tank.
- E. *Plastic Pipe Standards* - All plastic plumbing, appurtenances and fittings including the inlet and outlet tees and extension piping shall bear the certification mark of the National Sanitation Foundation International (NSF) for drain, waste and vent or sewer applications. Company products bearing the NSF mark demonstrate their continual compliance with NSF Standard 14 entitled, *Plastic Piping System Components and Related Materials*. As a minimum standard, all plastic pipe used in conjunction with the septic tank shall be type I schedule 40, polyvinyl chloride (PVC) meeting ASTM standard 2665 and bear the NSF certification mark for drain, waste and vent or sewer applications. Inlet and outlet pipes shall be sealed through use of a cast in place low-pressure pipe seal or equivalent neoprene gasket, flexible silicon adhesive or cement.
- F. *Inlet/Outlet Tee Standards* - The tees shall extend down a minimum of 25% and a maximum of 50% of the total liquid depth. It shall extend at least 5 inches above liquid level. The installer shall be responsible for proper installation of the tees. The invert of the outlet tee shall be at least two inches lower in elevation than the invert of the inlet tee.
- G. *Septic Tank Construction Standards* - The minimum capacity of a septic tank shall be 1000 gallons with manufacturer tolerance of plus (+) or minus (-) four percent (4%). All tanks shall be provided with a concrete partition so that the tank contains two compartments. Tanks without cast in place partitions shall be provided with a concrete partition so that the tank contains two compartments. At the intersection of the partition, for the type with a slip-in partition, the wall thickness at the intersection of the side wall may be reduced to two inches. The partition shall be located at a point not less than two-thirds (2/3) nor more than three-fourths (3/4) the length of the tank from the inlet end. The partition shall provide adequate space for air or gas passage between compartments. The partition shall be cast in such a manner to leave a water passage equal to or greater than the inlet pipe. The passage shall be located below the liquid level a minimum of 25% and a maximum of 50% of the total liquid depth. The partition shall be reinforced through use of six inch by six-inch number 10 gage-welded wire. The reinforcing wire on cast in place partitions shall be bent to form an angle of 90 degrees on the ends in order to form a leg not less than four inches long. When the wire is placed in the mold the four-inch legs should lay parallel with the sidewall wire adjacent to it. It is recognized that there are other methods of constructing a partition or two-compartment tank. Any method other than the one described will be considered on an individual basis for approval by the Department. However, the tank wall thickness must be two and one-half inches thick throughout the tank except for knockouts

and at the intersection of a slip-in type partition with the side walls, where it can be reduced to two inches and the top, which must be three and one-half inches (3 1/2") thick.

- H. *Tank Access Openings* - Adequate access openings must be provided in the tank top, which may be either one or two-piece construction. Access shall be provided for cleaning or rodding out of the inlet and outlet pipe, for cleaning or clearing the air or gas passage space above the partition, an entrance for inserting the suction hose for tank pumping, and for routine filter maintenance as needed. This shall be accomplished by properly locating access hole openings having securable, removable covers over the inlet and outlet tees with each having a minimum opening of 15 inches and a maximum of 24 inches as the opening cuts the plane of the bottom side of the top of the tank. The upper surface of the access hole may extend to finished grade or to a depth no deeper than 12 inches below the finished grade. The access hole covers shall be designed and maintained to prevent water inflow; they shall be beveled on all sides in such manner as to accommodate a uniform load of 150 pounds per square foot without damage to the cover or the top of the tank. All below grade access hole covers shall have a handle of steel or other rot-resistant material equivalent in strength to a # 3 reinforcing rod (rebar).
- I. *Tank Reinforcing* - Where steel reinforcing is used, a minimum of six-inch by six-inch # 10 gage welded steel reinforcing wire shall be used in the bottom, ends, and sides of the tank; in the top, three eights inch (3/8") reinforcing rods shall be used with a spacing of 12 inches on center each way extending to a minimum distance of two and one-half inches (2 1/2") and a maximum distance of three inches from the outside edge of the tank. The reinforcing wire shall be lapped at least six inches. Concrete cover shall be required for all reinforcement. Reinforcement shall be placed to maximize the structural integrity of the tank. The tank shall be able to withstand a uniform live loading of 150 pounds per square foot in addition to loads to which an underground tank is normally subjected. Examples of this are: the dead weight of the concrete and soil cover, active soil pressure on tank walls and the uplifting force of the ground water. Additional reinforcement shall be required when the loads on a concrete tank are exceeded by subjecting it to vehicular traffic or when the top of the tank is placed deeper than three feet below the finished grade. It is recognized there are methods of reinforcing concrete with fiber in lieu of reinforcing wire; however, when fiber is used, the reinforcing in the top must contain 3/8 inch steel rods (rebar) as specified in the paragraph above. When used, fiber reinforcing shall be 100% virgin polypropylene; fibrillated fiber containing no reprocessed olefin materials, and it must be manufactured specifically for use as concrete secondary reinforcement. Volume per cubic yard shall equal a minimum of 0.1 percent (1.5 pounds). Fibers are for the control of cracking due to drying shrinkage and thermal expansion/contraction, reduction in permeability, increased impact capacity, shatter resistance, abrasion resistance and added toughness. Fiber lengths shall be graded as per manufacturer with a maximum length of two inches. Fibrous concrete reinforcement materials used shall produce concrete conforming to specifications where concrete is tested in accord with ASTM C-1116 TYPE III 4.15 and ASTM C-1116 (reference: ASTM C-1018) performance level 15 outlined in Section 21, Note #17.
- J. *Tank and Wall Thickness* - The ends, sides and bottom of the tank must have a minimum thickness of two and one-half inches (2 1/2"). The top must have a minimum thickness of three and one-half inches (3 1/2").

- 
- K. *Compressive strength* - A minimum 28-day concrete compressive strength of 4,000 pounds per square inch shall be used in the construction of the septic tank. The concrete shall achieve minimum compressive strength of 3,000 pounds per square inch prior to removal of the tank from the place of manufacture. It shall be the responsibility of the manufacturer to certify that this condition has been met prior to shipment. A septic tank shall be subject to testing to ascertain the strength of concrete prior to its being approved for installation. Recognized devices for testing the strength of concrete include a properly calibrated Schmidt Rebound Hammer or Windsor Probe Test. Accelerated curing in the mold by use of propane gas or other fuels is prohibited, except in accordance with accredited methods and upon prior approval of The Department
- L. *Waterproofing* - After curing, tanks manufactured in two sections shall be joined and sealed at the joint by using a mastic, butyl rubber, or other pliable sealant that is waterproof, corrosion-resistant, and approved for use in septic tanks. The sealant shall have a minimum size of one-inch nominal diameter or equivalent. Before sealing, the joint shall be smooth, intact and free of all deleterious substances. Tank halves shall be properly aligned to ensure a tight seal. The sealant shall be provided by the manufacturer. Other methods of waterproofing tanks may be used as specifically approved in the plans and specifications for the tank.
- M. *Tank Markings* - All tanks shall bear an imprint, cast or stamp in the wall at the right of the outlet within six inches of the top of the wall. It shall identify the manufacturer and indicate the liquid capacity of the tank in gallons
- N. *Tank Figures* - Figure 5.D provides specifications that meet or exceed minimum septic tank design requirements.

#### 4) **Precast Concrete Pump/Dosing Tanks**

Pump tanks shall meet the construction requirements for septic tanks with the following differences. See also Section E as well as Figure 11.E.

- A. *Compartments* - Tanks shall be cast with a single compartment, or, if a partition is provided, the partition shall be cast to contain a minimum of two four-inch diameter circular openings, or equivalent, located no more than 12 inches above the tank bottom.
- B. *Dimensions* - There shall be no requirement as to tank length, width, or shape, provided the tank satisfies all other requirements of this Section.
- C. *Inlet* - The invert of the inlet openings shall be located within 12 inches of the tank top. No freeboard shall be required in the pump tank.
- D. *Waterproofing* - After joining, tanks manufactured in two sections shall be sealed along the joint by using a mastic, butyl rubber or other pliable sealant that is waterproof, corrosion resistant and approved for use in septic tanks. The sealant shall have a minimum size of one-inch diameter or equivalent. Before sealing, the joint shall be smooth, intact, and free of all deleterious substances. Tank halves shall be properly aligned to ensure a tight seal. The sealant shall be provided by the manufacturer. Other methods of waterproofing tanks may be used as specifically approved in the plans and specifications for the tank.

- E. *Access Openings* - Tanks shall be vented and accessible for routine maintenance. A watertight access with removable cover shall be provided over the pump with a minimum diameter of 24 inches. The cover shall be beveled on all sides in such manner as to accommodate a uniform load of 150 pounds per square foot without damage to the cover or the top of the tank. All below grade covers shall contain at least a handle made of steel or other rot resistant material equivalent in strength to a # 3 reinforcing rod (rebar). The access cover should extend to finished grade or to no deeper than 12 inches below finished grade. The covers shall be designed and maintained to prevent surface water inflow. Larger or multiple access covers shall be provided when two or more pumps are required. There must be a threaded union on the pump discharge pipe that will allow pump removal without entry into the tank. Access lids and electrical controls shall be secured against unauthorized opening or ingress. Access risers shall be joined to the tank top and sealed in accordance with D.19 of this Manual.
- F. *Pump Tank Markings* - All pump tanks shall bear an imprint, cast or stamp in the wall at the right of the outlet within six inches of the top of the wall. It shall identify the manufacturer and indicate the liquid capacity of the tank in gallons.

## 5) Septic Tanks Constructed on Site

Septic tanks constructed on site of cast-in-place concrete shall be constructed to conform with the requirements of precast concrete septic tanks except as follows:

- A. *Minimum Wall Thickness* - Cast-in-place concrete septic tanks shall have a minimum wall thickness of four inches.
- B. *Minimum Bottom Thickness* - The bottom and top of the constructed on-site septic tank shall be poured reinforced concrete with a minimum thickness of four inches.
- C. *Maximum Liquid Depth* - For large capacity (5,000 gallons or more) cast-in-place concrete tanks, maximum liquid depth shall be 66 inches.

## 6) Fiberglass Reinforced Plastic Septic Tanks

- A. *Definitions* - The following general definitions shall apply in the interpretation of these standards:
1. **ASTM.** Denotes nationally recognized standards established by the American Society for Testing and Materials.
  2. **Fiberglass Reinforced Plastic.** A fibrous glass and plastic mixture, which exhibits a high strength to weight ratio and is highly resistant to corrosion.
  3. **Flexural Modulus of Elasticity.** A measure of the stiffness of material.
  4. **Flexural Strength.** A measure of the ability of a material to withstand rupture when subjected to bend loading.
  5. **Gel Coating.** A specially formulated polyester resin, which is pigmented and contains filler materials, the purpose of which is to provide a smooth, pore-free, watertight surface for fiberglass reinforced plastic parts.

6. **National Sanitation Foundation (NSF) Standard #14.** The NSF standard relating to thermoplastics which have been tested and found satisfactory for potable water supply uses, for drain, waste and vent application.
  7. **Resin.** Any number of commercially available polyester products used in the manufacture of fiberglass reinforced products which serve to contribute mechanical strength, determine chemical and thermal performance, and prevent abrasion of fibers, and which must be physically and/or chemically determined to be acceptable for the environment and free from inert filler materials.
  8. **Sealant.** A bonding agent specifically designed to bond joining sections of fiberglass reinforced plastic products to each other in such a manner so as to create a durable, long-lasting, watertight seal which does not alter the structural integrity or strength of the two joined fiberglass products.
  9. **Fiberglass Septic Tank.** The minimum capacity of a septic tank shall be 1000 gallons. This is an approved watertight tank designed or used to receive the discharge of sewage from a building sewer and to effect separation of solids from liquids, retaining the solids for organic decomposition and discharging sewage effluent to an absorption field or other sewage management system. All tanks shall be provided with a partition so that the tank contains two compartments. The partition shall be located at a point not less than two-thirds (2/3) nor more than three-fourths (3/4) the length of the tank from the inlet end. The partition shall provide adequate space for air or gas passage between compartments. The partition shall provide for at least two passages with each equal to or greater than the cross-sectional area of the inlet pipe. The passage shall be located below the liquid level a minimum of 25% and a maximum of 50% of the total liquid depth.
  10. **Ultimate Tensile Strength.** A measure of the resistance of a material to longitudinal stress, measured by the minimum longitudinal stress required to rupture the material.
- B. *General Requirements* - The following general requirements are applicable to fiberglass reinforced plastic septic tanks as defined herein and approved design standards and structural properties shall be not less than those as stated herein:
1. *Materials* - Resins and sealants used in the tank manufacturing process shall be capable of effectively resisting corrosive influences of liquid components of sewage, gases generated by the digestion of sewage, and soil burial. Materials used shall be formulated to withstand vibration, shock, normal household chemicals, earth and hydrostatic pressure both when full and empty. Not less than thirty percent (30%) of the total weight of the tank shall be fiberglass reinforcement. For tanks not exceeding 1500 gallons capacity, the minimum wall thickness shall be 1/4 inch; however, isolated small spots may be as thin as 80% of the 1/4 inch minimum thickness.
  2. *Inner Coating* - Internal surfaces shall be coated with an appropriate gel coating to meet the requirements of Paragraph B.1 above.
  3. *Physical Properties* - Tanks shall be constructed so that all parts of the tank meet the following requirements:

- 
- a. Ultimate tensile strength - Minimum of 12,000 PSI when tested in accordance with ASTM D638-98, Standard Method of Test for Tensile Properties of Plastics.
  - b. Flexural Strength - Minimum of 19,000 PSI when tested in accordance with ASTM D790-98, Standard Method of Test for Flexural Properties of Plastic.
  - c. Flexural Modulus of Elasticity – (Tangent) Minimum of 800,000 PSI when tested in accordance with ASTM D790-98, Standard Method of Test for Flexural Properties of Plastics.
4. *Watertight Integrity* - Tanks shall be constructed to be watertight for the designed life of the tank. Lids or covers shall be sufficiently tight when installed to preclude the entrance of surface or ground water into the tank.
  5. *Longevity* - Proof from an independent testing laboratory shall be submitted substantiating a minimum life expectancy of twenty years of service for the intended use of the tank and appurtenant components such as necessary sealants, connective fastenings, resins, etc.
  6. *Safety* - As a safety measure, provision shall be made in the construction of septic tank lids or covers to preclude unauthorized entry or removal when the use of the tank necessitates positioning of access openings at or above ground level.
  7. *Workmanship* - Tanks shall be of uniform thickness and free from defects that may affect their serviceability or durability. Completed tanks are to present a smooth inside finish free of spalls, pits and honeycombs. Plant quality control shall be sufficient to maintain a high degree of uniformity in tank quality.
- C. *Detail Requirements* - Detail requirements for design and construction shall be not less than that specified herein and shall be in conformity with recognized National Standards for design and construction and in accordance with Chapter 511-3-1.
1. *Capacity and Design Limits* - Capacity of tanks shall comply with the requirements as set forth in Chapter 511-3-1-.05 (3).
  2. *Dimensions* - The inside length of a horizontal cylindrical tank shall not be less than twice the width nor more than three times the width. The liquid depth of septic tanks with capacities of less than 6,000 gallons shall not be greater than five feet. With septic tank capacities from 6,000 to 10,000 gallons, liquid depth may increase to a maximum of six feet. At least fifteen percent of the total volume of the tank shall be above the liquid level. If other shapes are proposed, specifications must be submitted to the Department for approval.
  3. *Compartments* - Multiple-compartmented septic tanks shall be used. The first compartment shall have a minimum capacity of two-thirds of the total tank capacity. Flow between compartments shall be by means of at least one opening in the compartment wall, with a cross-sectional area equivalent to the area of the building sewer, that leads into the tank, with the passage to be located below the liquid depth a minimum of 25% and a maximum of 50% of the total liquid depth. The partition shall provide adequate space for air or gas passage between compartments.

4. *Inlet* - Provisions shall be made for the building sewer to enter the center of one end of the septic tank two inches above the normal liquid level of the tank. A tee shall be constructed as an integral part of the tank to receive the building sewer or as an alternative, an integrally constructed baffle may be used. If baffles are used, suitable integrally fitted sleeves or collars shall be provided in the inlet openings of the tank to provide surface areas sufficient to insure capability of watertight bonding between the tank and the inlet sewer. If the tee or baffle is constructed of plastic materials, it shall meet NSF Standard #14 for drain, waste, and vent system application. If fiberglass reinforced plastic is used, it shall be of the same constituency as material of which the tank is constructed. The inlet tee or baffle shall extend down a minimum of 25% and a maximum of 50% of the total liquid depth. It shall extend at least five inches above liquid level and be placed and secured in a vertical position so as to be watertight and preclude dislodgement during installation, operation or maintenance activities.
5. *Outlet* - Provisions shall be made for the outlet sewer to receive the discharge from the tank by providing an opening in the center of the end of the tank opposite the inlet, the invert elevation of which shall be at the liquid level of the tank. A tee shall be constructed as an integral part of the tank to connect to the outlet sewer or as an alternative, an integrally constructed baffle may be used. If baffles are used, suitable integrally fitted sleeves or collars shall be provided in the outlet opening of the tank to provide surface areas sufficient to insure capability of watertight bonding between the tank and outlet sewer. If the tee or baffle is constructed of plastic material, it shall meet NSF Standard #14 for drain, waste and vent system application. If fiberglass reinforced plastic is used, it shall be of the same constituency as material of which the tank is constructed. The outlet tee or baffle shall extend down a minimum of 25% and a maximum of 50% of the liquid depth and be placed and secured in a vertical position so as to be watertight and preclude dislodgement during installation, operation or maintenance activities. The tee shall extend at least five inches above liquid level. A one-inch opening between the top of the inlet tee and top of the tank shall be provided to permit free passage of air or gas between the tank and the house sewer vent.
6. *Access Openings* - Openings in the top of the septic tank shall be provided over the inlet and outlet tees or baffles with a minimum cross-sectional width of 15 inches with a minimum area of 225 square inches, sufficient to enable maintenance service to such tees or baffles; access openings in the top of the septic tank shall be provided over each compartment in sufficient number to enable effective removal of solids from all parts of the tank. The access openings may extend to finished grade or to a minimum of 12 inches below finished grade. Covers for the access openings must be provided that are securable and water tight.
7. *Identifying Markings* - All tanks shall bear an imprint, cast or stamp in the wall at the right of the outlet within six inches of the top of the wall. It shall identify the manufacturer and indicate the liquid capacity of the tank in gallons.

## 7) Polyethylene Septic Tanks

- A. *General Requirements* - The following general requirements are applicable to polyethylene plastic septic tanks.

1. *Materials* - Resins and sealants used in the tank manufacturing process shall be capable of effectively resisting corrosive influences of liquid components of sewage, gases generated by the digestion of sewage, and soil burial. Materials used shall be formulated to withstand vibration, shock, normal household chemicals, earth and hydrostatic pressure both when full and empty.
  2. *Physical Properties* - Tanks shall be so constructed that all parts of the tank meet the following requirements:
    - a. Ultimate tensile strength - Minimum 2,400 PSI when tested in accordance with ASTM D 638- 01, Standard Method of Test for Tensile Properties of Plastics.
    - b. Flexural Strength - Minimum 80,000 PSI when tested in accordance with ASTM D790-01, Standard method of Test for Flexural Properties of Plastics
  3. *Watertight Integrity* - Tanks shall be so constructed as to be watertight for the designed life of the tank. Lids or covers shall be sufficiently tight when installed to preclude the entrance of surface or ground water into the tank.
  4. *Longevity* - Proof from an independent testing laboratory shall be submitted substantiating a minimum life expectancy of twenty years of service for the intended use of the tank and appurtenant components such as necessary sealants, connective fastenings, resins, etc.
  5. *Safety* - As a safety measure, provision shall be made in the construction of septic tank lids or covers to preclude unauthorized entry or removal when the use of the tank necessitates positioning of access openings at or above ground level.
  6. *Workmanship* - Tanks shall be of uniform thickness and free from defect that may affect their serviceability or durability. Completed tanks are to present a smooth inside finish free of spalls, pits and honeycombs. Plan quality control shall be sufficient to maintain a high degree of uniformity in tank quality.
- B. *Detail Requirements* - Detail requirements for design and construction shall be not less than that specified herein and shall be in conformity with recognized National Standards for design and construction in accordance with 511-3-1 as follows:
1. *Capacity and Design Limits* - Capacity of tanks shall comply with the requirements as set forth in Chapter 511-3-1-.05 (1) and Chapter 511-3-1-.05 (3).
  2. *Dimensions* - The inside length of a horizontal cylindrical tank shall not be less than twice the width nor more than three times the width. The liquid depth of septic tanks with capacities of less than 6,000 gallons shall not be greater than five feet. With septic tank capacities from 6,000 to 10,000 gallons, liquid depth may be increased to a maximum of six feet. At least fifteen percent of the total volume of the tank shall be above the liquid level. If other shapes are proposed, specifications must be submitted to the Department for review and approval.
  3. *Compartments* - Multiple-compartmented septic tanks shall be used, and when used, the first compartment shall have a minimum capacity of two-thirds of the total tank capacity. Flow between compartments shall be by means of at least one opening in the compartment wall, with a cross-sectional area equivalent to the area of the building

- sewer, that leads into the tank, with the passage to be located below the liquid level a minimum of 25% and a maximum of 50% of the total liquid depth. The partition shall provide adequate space for air or gas passage between compartments.
4. *Inlets* - Provisions shall be made for the building sewer to enter the center of one end of the septic tank two inches above the normal liquid level of the tank. A tee shall be constructed as an integral part of the tank to receive the building sewer. As an alternative, an integrally constructed baffle may be used. If baffles are used, suitable integrally fitted sleeves or collars shall be provided in the inlet openings of the tank to provide surface areas sufficient to insure capability of watertight bonding between the tank and inlet sewer. If the tee or baffle is constructed of plastic material, it shall meet NSF Standard #14 for drain, waste and vent system application. The inlet tee or baffle shall extend down to a minimum of 25% and a maximum of 50% of the liquid depth and be placed and secured in a vertical position so as to be watertight and preclude dislodgement during installation, operation or maintenance activities.
  5. *Outlet* - Provisions shall be made for the outlet sewer to receive the discharge from the tank by providing an opening in the center of the end of the tank opposite the inlet, the invert elevation of which shall be at the liquid level of the tank. A tee shall be constructed as an integral part of the tank to connect to the outlet sewer or as an alternative, an integrally constructed baffle may be used. If a baffle is used, suitable integrally fitted sleeves or collars shall be provided in the outlet opening of the tank to provide surface areas sufficient to insure capability of watertight bonding between the tank and outlet sewer. If the tee or baffle is constructed of plastic material, it shall meet NSF Standard #14 for drain, waste and vent system application. The outlet tee and any tee used as an opening for the baffle shall extend eighteen inches below the design liquid level and be placed and secured in a vertical position so as to be watertight and preclude dislodgement during installation, operation or maintenance activities. A one-inch opening between the top of the inlet tee and the top of the tank shall be provided to permit free passage of gas back to the house vent.
  6. *Access Openings* - Openings in the top of the septic tank shall be provided over the inlet and outlet tees or baffles, with a minimum cross-sectional width of 15 inches with a minimum area of 225 square inches, sufficient area to enable maintenance service to such tees or baffles; access openings in the top of the septic tank shall be provided over each compartment in sufficient number to enable effective removal of solids from all parts of the tank. The access openings may extend to finished grade or to a minimum of 12 inches below finished grade. Covers for the access openings must be provided that are securable and water tight.
  7. *Identifying Markings* - All septic tanks shall bear an imprint, cast or stamp in the wall at the right of the outlet within six inches of the top of the wall. It shall identify the manufacturer and indicate the liquid capacity of the tank in gallons.

## **8) Filtration Devices for Residential Gravity Flow Septic Tank Systems**

- A. *NSF Certification* - Filtration devices for residential gravity flow septic tank systems shall be certified by NSF International or an independent organization accredited by the

American National Standards Institute (ANSI) to determine compliance with the requirements of the most current ANSI/NSF Standard 46, Section 10 including but not limited to having the make and model of the effluent filter published in the accredited organizations public document and/or publicly available website that lists the company's name, address, telephone number and those products and model numbers successfully tested against the standard. These outlet filtration devices shall be accepted for installation and use in the state of Georgia.

- B. *NSF Marking* - Certified filtration devices shall bear a registered trademark that includes reference to ANSI/NSF Standard 46.
- C. *Filter Components* - Certified components (i.e. Filter casing or filter housing) intended to be used with other components to make a complete functional system, as defined by ANSI/NSF Standard 46, should bear a unit mark. Housing components intended to replace outlet tees (to make a complete functional system) must meet the provisions of DPH Rule 511-3-1-.05 (1) and Section D of the Department's Manual for On Site Sewage Management Systems.
- D. *Model Number* - Each filtration device or filtration system shall bear a permanently marked model designation on the device.

## 9) Aerobic Treatment Units

### A. Introduction

1. *Definition* - Aerobic treatment units (ATUs) provide aerobic biodegradation or decomposition of wastewater constituents by bringing the wastewater in contact with air mechanically. ATUs come in different configurations and sizes, and incorporate a variety of approaches, including air pumps, air injectors, lift pumps and biological-contact surfaces (such as pipes, fabric, grids, gravel and rotating disks). Other alternative sewage treatment technologies, such as sand filter systems, may also be described by this characterization; however, they are not classified by the Department as aerobic treatment units or systems.
2. *Pretreatment Prior to Disposal* - ATUs are stand-alone sewage treatment systems, providing wastewater treatment prior to disposal in a subsurface absorption system or pretreatment to other alternative methods of wastewater treatment and/or disposal.
3. *Wastewater Influent Characteristics* - The standards presented in this regulation apply to the use of ATUs for the treatment of sewage from residences (single-family or multi-family); wastewater that can be described as having the constituency and strength combined 5-day carbonaceous biochemical oxygen demand (CBOD<sub>5</sub>) typical of wastewater from domestic households (See Table 4.D). Some residential facilities or settings (group homes, extended care facilities, nursing homes, etc.) may generate sewage that is more complex and more difficult to treat and may better be described as non-residential. Similarly, other non-residential facilities (such as restaurants, dental or medical clinics, veterinary clinics, beauty shops, laundromats, etc.) may produce high-strength wastewater (significantly exceeding CBOD<sub>5</sub> levels acceptable for domestic households) making treatment difficult. Standards for ATUs designed to treat non-

---

residential wastewater or high-strength wastewater are reviewed for compliance by the Georgia Environmental Protection Division.

*B. Performance Standards*

1. *Listing* - Upon request, the Technical Review Committee (hereafter, the Committee) reviews proprietary ATU products; when the Committee determines that data provided by the manufacturer or designated manufacturer representative demonstrates that the product meets or exceeds the testing requirements, it will be added to the Approved List of the Department for such systems. An ATU must be included on the list of Approved Systems before local health officers may issue permits for installation of on-site sewage systems incorporating such products.
2. *Testing Criteria*
  - a. Aerobic treatment units must be tested by a qualified third-party organization independent from the manufacturer.
  - b. The Department and the Committee uses as performance and test criteria, the product standards, testing protocol and application standards for ATUs established by the National Sanitation Foundation International (NSF). Testing performed by independent ANSI accredited third-party test facilities will be reviewed by the Committee and approved by the Department on a case-by-case basis.
  - c. The testing criteria and performance levels for ATUs designed to treat residential sewage must at least be equal to that specified and required in the current ANSI/NSF Standard Number 40 - Residential Wastewater Treatment Systems. This applies to ATUs submitted to the Department for review and listing after the approval date of these standards.

*C. Application Standards*

1. *Listed Products* - Only ATUs listed on The Department's List of Approved Systems and Products shall be permitted by local health officers for systems installation within their jurisdiction. Only the specific models listed are approved. Other ATU models and/or products in manufacturers' product lines are not approved for use until they have been reviewed and approved by the Committee and placed on the Department list of Approved Systems and Products.
2. *Permitting and Installation Requirements*
  - a. Installation and if required, operational permits, must be obtained from the appropriate local health officer prior to installation and use.
  - b. Any variances or changes in the installation or use of these devices different from the conditions, allowances, or criteria contained in the Department's approval and the associated installation permit, issued by the local health authority, would void both the approval and the installation permit; such an altered system would then be classified as an experimental system, which would require further review by the Committee and a different type of approval by the Department.
  - c. An ATU must be installed by an authorized representative of the manufacturer approved by the Department.

- 
- d. Where an ATU is utilized, the bottom of the infiltrative surface elevation must be at least 12" above maximum seasonal high groundwater table, creviced or porous bedrock or strata of impermeable soil or bedrock (including very slowly permeable soil).
  - e. There must be sufficient acceptable land area on the property for installation of the ATU and a 100% set aside area for future replacement, should such ever be needed.
3. *Pretreatment* - External pretreatment for solids separation and settling will be provided by a conventional, single compartment septic tank equivalent, at minimum, to the expected 24-hour sewage flow for the residence or facility. Any ATU tested using ANSI/NSF Standard 40, or equivalent, may be excluded from the requirement of a separate pretreatment tank if such a "trash compartment or tank" is part of their approval. The "trash tank" used for pretreatment must meet the minimum structural standards as established by the Manual and approved for use by the Department. An inlet and outlet "tee" as described in the Manual, must be installed in the pretreatment tank.
  4. *ATU Size/Model Selection* - For residential wastewater flows, in the absence of actual flow data, ATU sizing will be based upon a projection of 150 gallons per day (gpd) flow per bedroom. The size ATU needed will be determined by manufacturer recommendations for the ATU capable of treating the actual or projected flow.
  5. *Access Ports* - Ground level access ports must be sized and located to facilitate the installation, removal, sampling, examination, maintenance, and servicing of components and compartments that require routine maintenance and inspection. In accordance with the manufacturer operation and maintenance manual, access ports must be of sufficient size, design and location so as to allow for the following:
    - a. Visual inspection and removal of all mechanical or electrical components;
    - b. Visual inspection and removal of any component which is to be periodically cleaned or replaced;
    - c. Visual inspection and sampling;
    - d. Removal (manually or by pumping) of collected residuals; and
    - e. Protection against unauthorized intrusions. Acceptable protective measures include, but are not limited to:
      - (1) A padlock;
      - (2) A cover that can be removed only with tools; and
      - (3) A cover having a minimum net weight of 65 pounds (29.5 kilograms).
    - f. Protection from ground water inflow.
  6. *Failure Sensing and Signaling Equipment* - The ATU must possess a mechanism or process capable of detecting failures of electrical and mechanical components critical to the treatment processes and delivering a visible and audible alarm signal to notify the owner of such failures that result in:

- 
- a. Water level above normal operating specifications; or
  - b. Aeration equipment not functioning within manufacturer specified limits.
7. *Alarm Requirements* - Both the visual and audible alarm signals must be conspicuous from a distance of 50 feet from the system and its appurtenances. The audible alarm signal must produce sound levels between 60 and 75 dbA at a distance of five feet away from the unit.
  8. *Separate Circuits Required* - The visual and auditory signals must continue to be functional in the event of an electrical, mechanical, or hydraulic malfunction of the system.
  9. *Data plate* - An ATU must have two permanent and legible data plates. One data plate must be affixed to the front of the electrical control box. The second data plate must be placed on the tank, aeration equipment assembly, or riser at a location accessed during maintenance cycles and inspections. The data plates must include:
    - a. Manufacturer's name and address;
    - b. Model number;
    - c. Serial number (required on one data plate only);
    - d. Rated daily hydraulic capacity of the system; and
    - e. The system classification as determined by performance testing and evaluation.

A clearly visible label or plate that provides instructions for obtaining service must be permanently located near the failure signal.

10. *Extended Electrical Power Interruption* - ATU performance begins to decrease as a result of extended power failure (generally over 48 to 72 hours). In areas subject to extended power interruptions, the benefit of providing an emergency power supply should be considered in the overall sewage system design/review process.

#### D. *Operation & Maintenance Standards*

1. *General*
  - a. The residence or facility owner is responsible for assuring proper operation and providing timely maintenance of the ATU and all other components of the on-site sewage treatment and disposal system.
  - b. The manufacturer must provide the Department and local health authority annually a list of ATU's sold/installed. As a minimum, the list must contain in table format the following:
    - (1) County where installed;
    - (2) City where installed;
    - (3) Owner's name;
    - (4) Owner's street address;

- 
- (5) Owner's zip code;
  - (6) Owner's phone number;
  - (7) Tank serial number;
  - (8) Installation date; and
  - (9) Date warranty ends and, if different, date service contract ends.
- c. The ATU authorized representative must instruct, or assure that instruction is provided to the residence or facility owner in proper operation of the ATU. Emphasis must be placed on those aspects that relate to operating and maintaining the ATU within its normal operating range. This should include instruction regarding items in Product Manual (s) below.
2. *Product Manuals* - Manufacturers must provide authorized representatives with product literature intended to accommodate all persons who may be involved in the installation, upkeep, or repair of the systems. This information may be provided in the form of separate, discrete manuals or may be combined into one comprehensive manual, as the manufacturer deems appropriate. The manual must be written so as to be easily understood by the intended reader. As a minimum the manual must include specific instruction for: System Installation, Operation and Maintenance, and Trouble Shooting and Repair as described below.
- a. *System Installation* - Manufacturers must provide comprehensive and detailed installation instructions to authorized representatives and the local health officer. At a minimum the following must be included:
- (1) A numbered list of system components and an accompanying illustration, photograph or print in which the components are respectively identified;
  - (2) Design, construction, and material specifications for the system's components;
  - (3) Wiring schematics for the system's electrical components;
  - (4) Off-loading and unpacking instructions including safety considerations, identification of fragile components, and measures to be taken to avoid damage to the system;
  - (5) A process overview of the function of each component and the expected function of the entire system when all components are properly assembled and connected;
  - (6) A clear definition of system installation requirements including plumbing and electrical power requirements, ventilation, air intake protection, bedding, hydrostatic displacement protection, water tightness, slope and miscellaneous fittings and appurtenances;
  - (7) A sequential installation procedure;
  - (8) Repair or replacement instructions in the event that a system possesses flaws that would inhibit proper functioning and a list of sources where replacement components can be obtained; and

- 
- (9) A detailed start-up procedure.
- b. *Operation and Maintenance* - Manufacturers must provide comprehensive and detailed operation and maintenance instructions to the authorized representatives, to the local health officer and to the owner. Comprehensive operating instructions must clearly delineate proper function of the system, operating and maintenance responsibilities of the owner and authorized service personnel and service related obligations of the manufacturer. At a minimum, the following must be included:
- (1) A maintenance schedule for all components; copies of the periodic maintenance reports must be provided to the owner and the local health authority;
  - (2) Requirements and recommended procedures for the periodic removal of residuals from the system;
  - (3) A detailed procedure for visual evaluation of system component functions;
  - (4) A description of olfactory and visual techniques for the evaluation of system effluent and mixed liquor;
  - (5) A list of household substances that, if discharged to the system, may adversely affect the system, operational processes and/or the environment.
- c. *Trouble Shooting and Repair* - Manufacturers must provide comprehensive and detailed trouble-shooting and repair instructions to authorized representatives, the local health officer, and to the owner. At a minimum, the following must be included:
- (1) A guide for visually evaluating the system and narrowing the scope of the problem based on effluent characteristics, system operation, and history; detailed methods and criteria must be included;
  - (2) A sequential method for isolating specific component failure;
  - (3) A step-by-step guide for repairing or replacing all system components; and
  - (4) The name and telephone number of an appropriate service representative to be contacted in the reference to the system data plate in the event that a problem arises or service is required to obtain this information.

E. *Service Related Obligations*

1. *Initial Service Policy:*

- a. A three-year initial service policy must be furnished to the owner by the manufacturer or the authorized representative; the cost of the initial service policy must be included in the original purchase price. The initial policy must contain provisions for six inspection/service visits (scheduled once every six months over the three-year period) during which electrical, mechanical, and other applicable components are inspected, adjusted and serviced.
- b. The initial service policy must contain a clause that states that the owner must be notified in writing about improper system operations that cannot be remedied at the time of inspection, and that the written notification must include an estimated date

of correction. If the malfunction is expected to cause a sewage backup into the dwelling or a surface discharge of effluent, then a copy must be furnished to the local health authority.

- c. Service providers must maintain accurate records of their Service Contracts, customers, and time lines for renewal of service contracts.
2. *Submission of Maintenance Reports* - The manufacturer or licensed distributor shall submit to the Department and county health authority by March 15th reports of each visit for maintenance conducted during the previous year. Information such as name and address of the owner, date of visit, reason for the visit, and corrective action taken shall be included in the report. Failure to submit timely reports may result in the suspension of the license to market the system in Georgia. The NSF Onsite Monitoring Program or equivalent, accessible by the Department, district office, county, and homeowner, may be used in lieu of the maintenance reporting requirements if such reporting system includes the information required by the Department.
3. *Extended Service Policy* - A manufacturer or authorized representative must make available, for purchase by the owner, an extended service policy with services provided as extensive as or greater than those in the initial service policy. The owner must obtain such a service policy or insure that equivalent maintenance and repair service is provided. Maintenance and the periodic reporting requirements noted in the paragraph above must continue for the life of the system.
4. *Stand-by Parts* - In the event that a mechanical or electrical component must undergo off-site repairs, the local authorized representative must maintain a stock of mechanical and electrical components that may be temporarily installed until repairs are completed.
5. *Availability of Service* - Emergency service must be available within 48 hours of a service request.
6. *Limited Warranty* - The manufacturer must warrant all components of their ATU to be free from defects in material and workmanship for a minimum of two years from the date of installation. The manufacturer must fulfill the terms of the warranty by repairing or exchanging any components that, in the manufacturer's judgment, show evidence of defect.
7. *Owner's Manual* - Each ATU must be accompanied by a manufacturer prepared owner's manual. The authorized representative must provide copies of the manual to the owner and the local health officer, at the time of system installation.
8. *Contractor/Service Provider* - Any contractor installing or performing work on an Advanced Treatment System (ATS) must be provided with a certificate or card that demonstrates their completion of the manufacturer's certification program. All ATS manufacturers must submit a listing of their certified installers and service providers with their annual maintenance reports. Any additions or deletions to this list must be submitted to the Department and county.

## 10) Class I Effluent Systems

- 
- A. *Other Types of Pretreatment Systems* - The Department recognizes other types of pretreatment systems are capable of producing a Class I effluent. Pretreatment systems capable of producing a Class I effluent must meet the following testing requirements. Third party testing from an accredited testing facility acceptable to the DPH Technical Review Committee showing the system meets current ANSI/NSF Standard 40 testing requirements for Class I effluent.
- B. *Annual Listing* - The manufacturer shall provide the Department and local health authority an annual listing of system installations. At a minimum the list must contain the following information:
1. County where installed;
  2. City where installed;
  3. Owner's name;
  4. Owner's address;
  5. Owner's zip code;
  6. System serial number;
  7. Installation date;
  8. Date the service policy ends;
  9. Date warranty ends, and if different, date service contract ends.”
- C. *Service-Related Obligations*
1. *Initial Service Policy*
    - a. The manufacturer or the authorized representative must furnish a three-year initial service policy to the owner; the cost of the initial service policy must be included in the original purchase price. The initial service policy must contain provisions for annual service visits (a minimum of one service visit/year) during which electrical, mechanical, and other applicable components are inspected, adjusted and serviced.
    - b. The initial service policy must contain a clause that states that the owner will be notified in writing about improper operations that cannot be remedied at the time of inspection and that written notification must include an estimated date of correction. If the malfunction is expected to cause a sewage backup into the dwelling or a surface discharge of effluent, then a copy must be furnished to the local health authority.
    - c. Service providers must maintain accurate records of their service contracts, customers and time lines for renewal of service contracts.
  2. *Submission of Maintenance/Service Reports* - The manufacturer or licensed distributor shall submit to the Department and county health authority by March 15<sup>th</sup> reports of maintenance/service visits conducted during the previous year.
  3. *Extended Service Policy* - The manufacturer or authorized representative must make available, for purchase by the owner, an extended service policy with services equal to or greater than those provided by the initial service policy. The owner must obtain such

- a service policy or insure that equivalent maintenance is provided. Maintenance and periodic reporting must continue for the life of the system.
4. *Owner's Manual* - A manufacturer prepared owner's manual must accompany each Advanced Treatment System. The authorized representative must provide copies of the manual to the system owner at the time of installation.

## 11) Nitrogen Reduction

- A. *Testing Criteria* - In areas of the State which have been identified that must reduce nitrogen in surface and ground water, the Department has adopted NSF/ANSI Standard 245, or equivalent, to evaluate residential wastewater technologies designed for nitrogen reduction. Technologies tested against Standard 245 must either be Standard 40 certified or be evaluated against Standard 40 and must meet all requirements of Aerobic Treatment Units found in this Manual including but not limited to application standards, operation and maintenance, and service related obligations.
- B. *Performance Standards* - A pretreatment system must produce the following effluent concentrations to meet Standard 245:
  1. CBOD5 - 25 mg/L
  2. TSS - 30 mg/L
  3. Total Nitrogen - at least a 50% average of influent TKN
  4. pH - 6.0 to 9.0

## 12) Portable Toilets

Portable toilets fitted with a sewage receptacle of easily cleanable and impervious construction, which is easily accessible for cleaning, may be used at construction sites or places of public assembly of a temporary nature; provided such toilets are provided in numbers adequate to serve the anticipated usage and are cleaned and serviced regularly, and the waste removed from them is disposed of in a manner approved by the County Board of Health in accordance with The Department of Public Health's Chapter 511-3-6, Titled *Portable Sanitation Contractors*.

## 13) Incinerator Toilets

Where waste generation is greatly limited, such as a remote office staffed by a limited number of people, and where no waste water from kitchens, bath or laundry is expected, incinerator toilets which use gas or electrical energy to incinerate feces and urine in timed cycles may be considered. The waste is reduced to a dry ash product, which must be removed periodically. Disposal of the ash should be accomplished by land burial and covered with a minimum earth cover of six inches. The use of such toilets where kitchen, laundry, bath and toilet waste are expected is not recommended since a conventional septic tank system would be required to treat the kitchen, bath and laundry waste. Incinerator toilets must be certified by the National Sanitation Foundation as meeting the current Standard #41 or certified by the manufacturer as meeting a nationally recognized standard for such purpose.

---

## 14) Composting Toilets

Where the availability of land for installation of conventional septic tank systems is limited so as to allow for only a septic tank and a reduced size absorption field system, composting toilets may be considered. Such units, especially the larger ones, commonly receive garbage and human wastes, which are acted upon by microorganisms, ultimately resulting in the creation of a compost that may be used as a soil amendment. Large composting units can handle toilet and kitchen scraps, while the smaller self-contained units only accept toilet wastes (see Figure 7.D). Laundry, bath, and kitchen wastes must be disposed of in a conventional septic tank system, although the size of the absorption field may be reduced by 35 percent from that required for a conventional system, provided devices which restrict flow to no more than 3 gpm on shower heads and other appropriate water-using fixtures are installed. Composted wastes from the treatment unit shall be removed as per the manufacturer's recommendations and the residue shall be buried by covering with at least six inches of soil. Wastes should not be used as fertilizer for root or leaf crops, which may be eaten raw. All manufacturers' recommendations shall be followed as to the installation, operation and maintenance requirements of the units. Composting toilets must be certified by the National Sanitation Foundation as meeting the current Standard # 41 or certified by the manufacturer as meeting a nationally recognized standard for such purpose.

## 15) Water Saving Devices and Fixtures

The County Board of Health may consider a proposal to reduce estimated daily sewage flow where it is clearly established that workable, effective water saving devices will be installed. An example would be the use of low water use toilets in facilities where essentially all of the waste generated is from toilet use.

## 16) Separate Black Water - Gray Water Systems

- A. *Gray Water Tank Sizing* - Where a separate gray water system is to be used, the minimum effective capacity of the gray water retention tank shall be 500 gallons. Otherwise the design shall meet the requirements of "Section 511-3-1-.05 Rules for On-Site Sewage Management Systems." If a gray water system is to be used for residential development, for each bedroom over four (4), an additional one hundred and thirty (130) gallons capacity shall be provided. Gray water retention tank capacities for commercial or industrial developments shall be computed by taking 65% of the total sewage flow, using the sewage flow schedule (see Pages J-1 through J-3).
- B. *Black Water Disposal* - There are a number of devices which can be used to treat or dispose of the black water waste, such as composting toilets, incinerator toilets, absorption fields or mound systems, etc. However, if absorption is selected as the disposal method, the absorption area shall be preceded by a conventional septic tank designed according to Section 511-3-1-.05 "Rules for On-Site Management Systems."
- C. *Non-Residential Facilities* - The minimum absorption area for gray water or black water absorption systems serving commercial, industrial, or similar facilities shall be based on the total daily sewage flow (Section J) and percolation coefficient calculations (Table 9.F).

The black water portion of the total daily sewage flow shall be thirty-five percent (35%) and the gray water portion shall be sixty-five percent (65%).

- D. *System Sizing* - The minimum absorption area for gray water or black water absorption systems serving residential properties (single family and multifamily) shall be based on the number of bedrooms and the percolation rate (see Table 10.F, for single family homes and Table 9.F for multifamily homes). The black-water portion of the total daily sewage flow shall be thirty-five percent (35%) and the gray water portion shall be sixty-five percent (65%).

## 17) Privies

- A. *Location* – Pit privies shall be located downgrade and not less than 100 feet from any well or spring used as a source of water supply for domestic use and human consumption and not less than 20 feet from any property line. Pit privies shall meet all additional absorption field setback requirements.
- B. *Size of Pit* – The pit shall be an excavation approximately three feet six inches square and not less than three feet deep or greater than five feet.
- C. *Floor and Riser* – A floor at least four feet square with a riser and lid shall be placed over the pit in such a manner as to prevent access of rodents and insects to the pit. The seat lid shall be hinged as to close automatically and remain closed when not in use.
- D. *Earth Backfill* – Sufficient tamped earth fill shall be placed around the base of the pit privy in such a manner as to prevent surface water from entering the pit.
- E. *Use* – Privies may be constructed, installed or used for sewage storage and disposal where water under pressure is not available within the building structure or where approved gray water disposal systems are provided. Use of the pit privy shall be discontinued and the pit filled with earth when the contents of the pit accumulate to within 18 inches of the ground surface. (See Figure 10.D for pit privy design). Vault type privies may be pumped out.
- F. *Soil Evaluation* – A soil report consisting of soil characteristics, including; soil types and capabilities; frequency and evaluation of seasonal high ground water tables, occurrence of rock, and/or other impervious strata shall determine whether a pit privy will be approved for installation (See Section C).

## 18) Grease Traps

- A. *Description* – In certain commercial / institutional applications, grease can clog sewer lines and inlet and outlet structures in septic tanks, resulting in restricted flows and poor septic tank performance. The purpose of a grease trap is simply to remove grease from the waste stream prior to treatment. Grease traps are tanks into which grease flows and is retained. Grease floats to the water surface while the cleaner water underneath is discharged to a septic tank. The type of grease traps discussed here are outside tanks. Grease trap tank design is similar to that of a septic tank (See Figures 8.D and 9.D).
- B. *Application* – Influent to grease traps usually contain high organic loads including grease, oils, fats and dissolved food particles. Grease traps are used for treating wastewater when

the grease content is in excess of 50 mg/l. This primarily occurs with kitchen wastewater from cafeterias, restaurants, hospitals, schools and other institutions with kitchens that produce a large volume of wastewater. Sanitary wastewater should not be treated through the grease trap. Wastewater from garbage grinders should not be discharged to the grease trap, as higher solids loadings can upset grease trap performance and increase solids accumulation.

- C. *Factors Affecting Performance* – Several factors can affect the performance of grease traps: wastewater temperature, solids concentrations, inlet conditions, retention time and maintenance practices. By placing the grease trap close to the source of the wastewater generator (usually kitchen), where the wastewater is still hot, allows the grease to flow into the grease trap before congealing. As the grease cools in the grease trap, grease separation is facilitated. Flow control fittings may be needed on the inlet side of smaller grease traps to protect against overloading or sudden surges. These surges can cause agitation in the trap, impede grease floatation and allow grease to escape through the outlet. High loading and short retention time may not allow grease to separate fully, resulting in poor removal. Therefore, it is important to properly size the grease trap for the expected peak flow generated by the facility served. Maintenance practices are important, as failure to properly clean and remove grease accumulation can result in excessive buildup that can lead to the discharge of grease into the system.
- D. *Sizing* – The following sizing equations have been developed through years of field experience for restaurants and other types of commercial kitchens. See examples for the use of the appropriate formulas. The minimum size grease trap should be 125 gallons.

1. *Restaurants:*

$$(S) \times (GS) \times (HR/12) \times (LF) = \text{GT capacity}$$

S = Number of seats in dining area

GS = Gallons of wastewater per seat (Use 25 gallons per seat)

HR = Number of hours open

LF = Loading Factor

2.0 Interstate freeway

1.5 Other freeway

1.25 Recreational area

1.0 Main highway

0.75 Other highways

Example 1: For a restaurant with a 75 seat dining area, 12-hour day operation, a typical discharge of 25 gallons per seat and located on a main highway, the size of the grease trap is calculated as follows:

$$(75) \times (25) \times (12/12) \times (1.0) = 1875 \text{ gal. capacity}$$

2. *Hospitals, Nursing Homes, Other types of Commercial Kitchens with varied seating:*

$$(M) \times (GM) \times (LF) = \text{GT capacity}$$

M = Meals per day

GM = Gallons per meal (Use 5 gallons per meal)

LF = Loading Factor

1.0 with dishwashing

0.5 without dishwashing

Example 2: A nursing home with 100 beds, serves 300 meals per day, a discharge of 5 gallons per meal and a loading factor with dishwashing of 1.0. The size of the grease trap is calculated as follows:

$$(300) \times (5) \times (1.0) = 1500 \text{ gal. capacity}$$

- E. *Construction Features* – Grease traps are generally made of precast concrete, and are purchased completely assembled. However very large units may be field constructed. Minimum design requirements for precast concrete septic tanks apply to concrete grease trap except as discussed here in Section D and as shown in Figures 8.D and 9.D. Grease traps are usually buried so as to intercept the building sewer. They must be level, located where they are easily accessible for cleaning and close to the wastewater source. Where efficient removal of the grease is very important, a two-chamber grease trap design may be used which has a primary grease separating chamber. The inlet, outlet and baffle fittings are typical of “Tee” design with a vertical extension 12 inches from the tank floor and reaching well above the water line. To allow for proper maintenance, access to finish grade must be provided. The access covers should be gas tight construction and should be designed to withstand expected loads. A check of local plumbing ordinances and codes should always be made before the grease trap is designed or purchased.

Other design considerations include: facilities for insuring ease of access for cleaning and maintenance; and inaccessibility of the grease trap to insects and vermin.

- F. *Operation and Maintenance* – In order to be effective, grease traps must be operated properly and cleaned regularly to prevent the escape of appreciable quantities of grease. The frequency of cleaning at any given installation can best be determined by experience based on observation. Generally, cleaning should be done when 75% of the grease retention capacity has been reached. At restaurants, pumping frequencies range from once per week to once every two or three months.

## 19) Septic Tank Riser and Lid Systems

- A. *Concrete Riser and Lid Systems* - Septic tanks with more than 12 inches of soil cover are required to use a riser to bring the tank access to within 12 inches of the grounds surface. The following minimum design, material, and construction standards are applicable to septic tank riser and lid systems manufactured using concrete:

- 
1. Risers shall be made of concrete having a minimum 28-day compressive strength of 4,000 PSI.
  2. Risers shall be flanged to facilitate stacking for varying tank depths and shall be attached to the top of the tank by means of butyl mastic or equivalent approved sealant. Individual stacked riser sections shall be jointed with butyl mastic or equivalent approved sealant.
  3. Riser walls shall have a minimum thickness of 2 inches.
  4. All precast concrete risers shall be reinforced with either 6 x 6 inch, # 10 gauge welded wire mesh or reinforcing fiber designed specifically as a secondary concrete reinforcing material.
  5. Riser lids must contain 6 x 6 inch, #10 gauge welded wire mesh as a minimum reinforcing and must maintain a minimum thickness of 3 ½ inches. Riser lids may be designed to fit either as a wedge into the top of the riser or as a flanged seat. All lids must be provided with a handle of 3/8-inch (#3) rebar or equivalent rot resistant material. Lid handles shall have at least a 1-inch clearance between the lid top and the closest point of the handle.
  6. Riser lids shall be designed to withstand a uniform load of 150 pounds per square foot.
  7. Risers that extend to the ground surface shall have a securable lid to prevent unauthorized access. Concrete riser lids may be considered “secured” if the weight of the lid is a minimum of 65 pounds and cannot be removed by horizontal sliding.
- B. *Non-Concrete Septic Tank Riser and Lid Systems* - Septic tanks with more than 12 inches of soil cover are required to use a riser to bring the tank access to within 12 inches of the grounds surface. The following minimum design, material, and construction standards are applicable to septic tank riser and lid systems manufactured using materials other than concrete:
1. *Materials* - Materials used in the riser and lid manufacturing process shall be capable of effectively resisting corrosive influences of liquid and gas components of sewage as well as withstanding the physical factors that may affect the structural integrity of the risers. Materials used shall be formulated to withstand vibration, shock, normal household chemicals, by-products of sewage digestion, and expected geostatic and hydrostatic stresses. Verification of the material requirements must be provided by the manufacturer.
  2. *Stress testing* - One of the following assembly stress tests must be submitted:
    - a. Inches Hg vacuum with minimal joint seal deflection;
    - b. Compressive to 2500 lbs. center loading; compressive to 4500 lbs. full assembly and center loading; compressive to 6000 lbs. uniform loading;
    - c. Compression to deformation at 500 psi @ 3000 lbs. load or at 1000 psi @ 6000 lbs. load; or
    - d. ASTM D-1784 tested in accordance with AASHTO M304M.
  3. *Riser Lids* - Riser lids shall withstand the following stress testing:

- a. 150 lbs. / sq. ft. uniform live load; and
  - b. 1500 pound 10 by 10-inch area center loading in accordance with ASTM C- 890.
4. *Verification* - Stress testing shall be verified in writing by a Registered Engineer.
  5. *Security* - Provision shall be made in the construction of septic tank riser lids to prevent unauthorized entry or removal when the access openings are at or above ground level. Lids must be fastened to the riser by use of stainless steel nuts and bolts or other approved lockout mechanism.
  6. *Watertight Assembly* - Riser and lid systems shall be so constructed as to be watertight. Risers and lids shall be sufficiently tight when installed to preclude the entrance of surface or ground water into the tank for the designed life of the assembly. Riser segments and lid attachment must include an o-ring gasket or bead of mastic to seal all joints. Sealants shall be capable of effectively resisting corrosive influences of liquid and gas components of sewage as well as withstanding the physical factors that may affect the structural integrity of the riser system. Materials used shall be formulated to withstand vibration, shock, normal household chemicals, by-products of sewage digestion, and expected geostatic and hydrostatic stresses.
  7. *Attachment to tank* - For installation on new concrete tanks, plastic risers must be attached by means of an integrally (cast in place) molded casting ring. Installation of risers onto existing tanks may be achieved with the use of a bolt-on attachment ring, adhesive mastic, or epoxy adhesive compatible with the riser material. Risers that are part of a tank manufacturer's proprietary integrated tank and riser system may be attached by screw type threads molded into the tank and riser or other approved connection method.
  8. *Workmanship* - Risers and lids shall be free from defect that may affect their serviceability or durability.
  9. *Listing* – Upon request, the Department will review riser and lid system products; when the Department determines data provided by the manufacturer demonstrates the product meets or exceeds established design and material requirements, it will be added to the official Product Approvals List. All non-concrete septic tank riser and lid systems must be approved by the Department for use in Georgia.

---

**20) Tables, Figures, Forms**
**Table 4.D Performance Standards/Testing Protocol for Aerobic Treatment Units**

ATU Performance Objective	Wastewater Influent	Wastewater Effluent	Test Protocol
NSF Class I	CBOD <sub>5</sub> (4): 100-300 mg/L (2)	CBOD <sub>5</sub> : 25mg/L (2)	NSF 40 (1)
	TSS (5): 100-350 mg/L (2)	TSS: 30 mg/L (2) 45 mg/L (3)	
	pH: No Standard	pH: 6.0 - 9.0	
	No Bacterial Standard	No Bacterial Standard	
(1) NSF International Standard for Wastewater Technology/Residential Wastewater Treatment Systems (2) 30-day average (3) 7-day average (4) Combined 5-day Carbonaceous Biochemical Oxygen Demand (5) Total Suspended Solids			

Figure 5.D Septic Tank Specifications

DETAIL TABLE	
A	MINIMUM 15" MAXIMUM 24"
B	2/3 TO 3/4 OVERALL LENGTH
C	1/3 TO 1/4 OVERALL LENGTH
D	MINIMUM 1 1/2 TIMES WIDTH
E	WIDTH
F	1" MINIMUM
G	25 TO 50% OF LIQUID DEPTH
H	MINIMUM 9"
I	MINIMUM 36"
J	MINIMUM 3 1/2"
K	50% TO 75% LIQUID DEPTH
L	MINIMUM 2"
N	MINIMUM 2 1/2"
O	EQUAL IN STRENGTH TO NO.3 REBAR
P	IDENTIFICATION STAMP
Q	AT LEAST EQUAL IN SIZE TO INLET PIPE
R	MINIMUM 2"

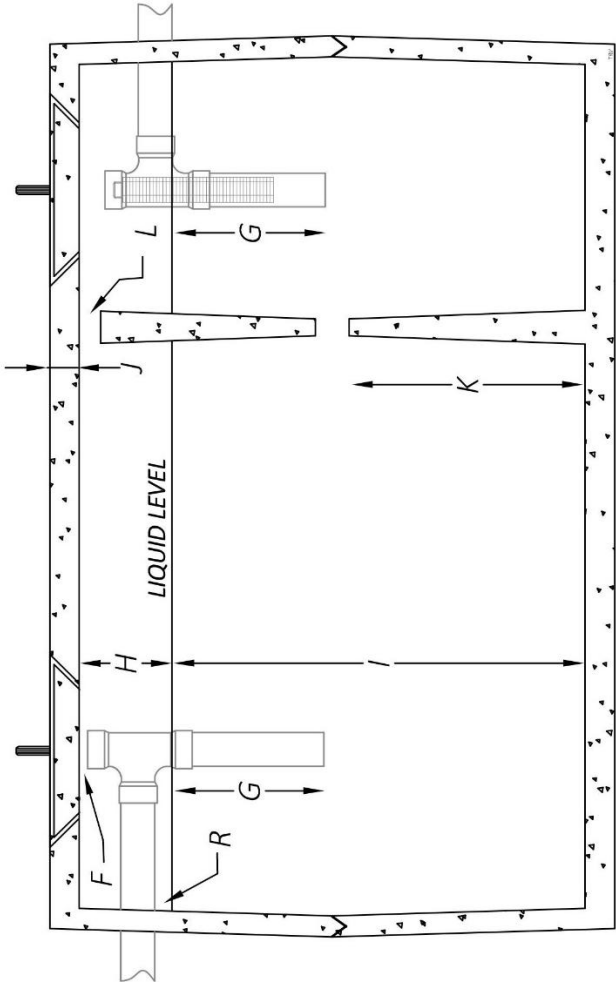
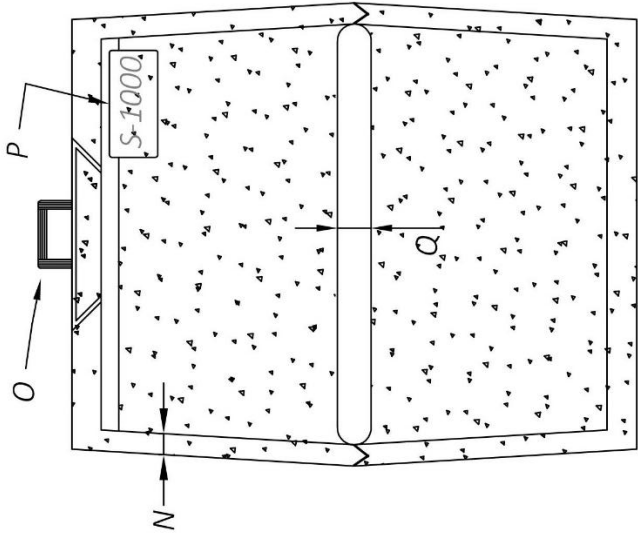
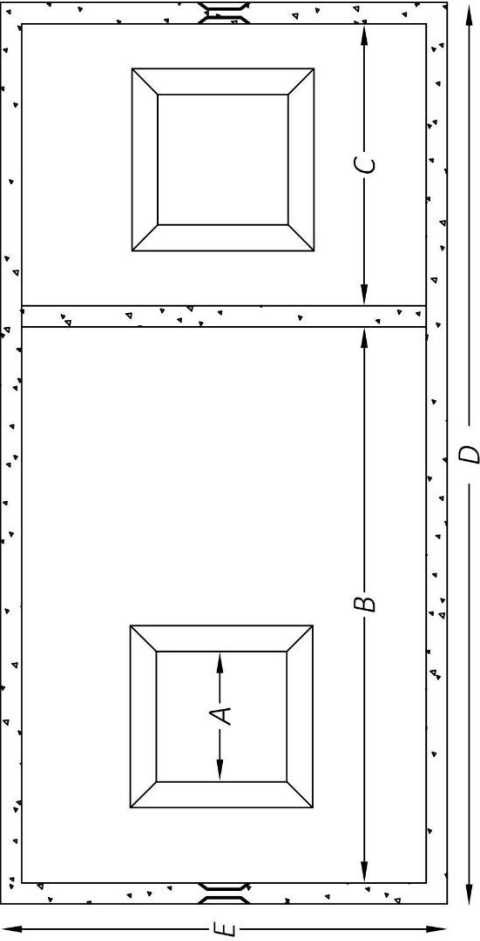

Figure 6.D Aerobic Treatment Unit

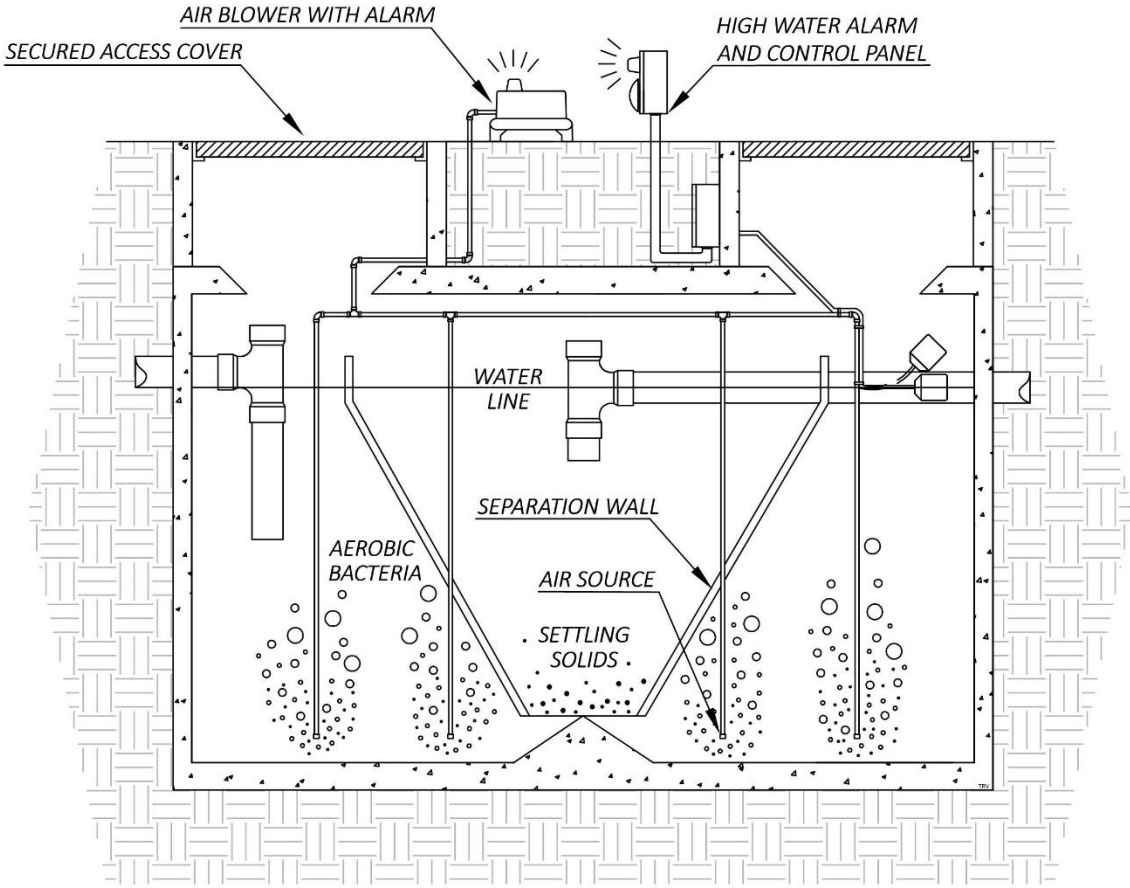

Figure 7.D Typical Composting Toilets

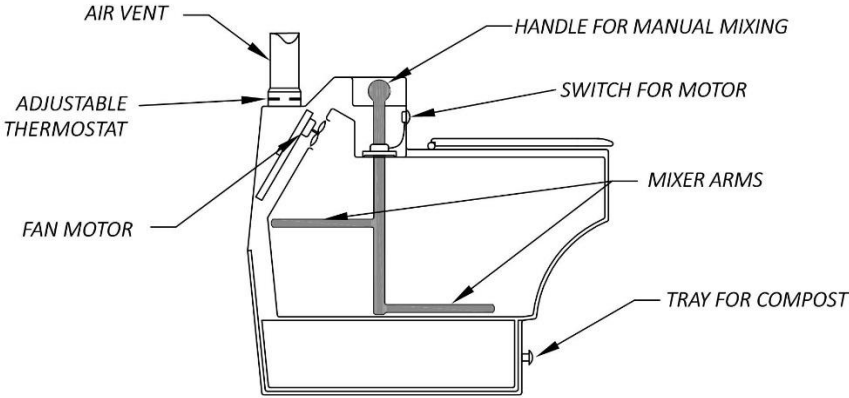
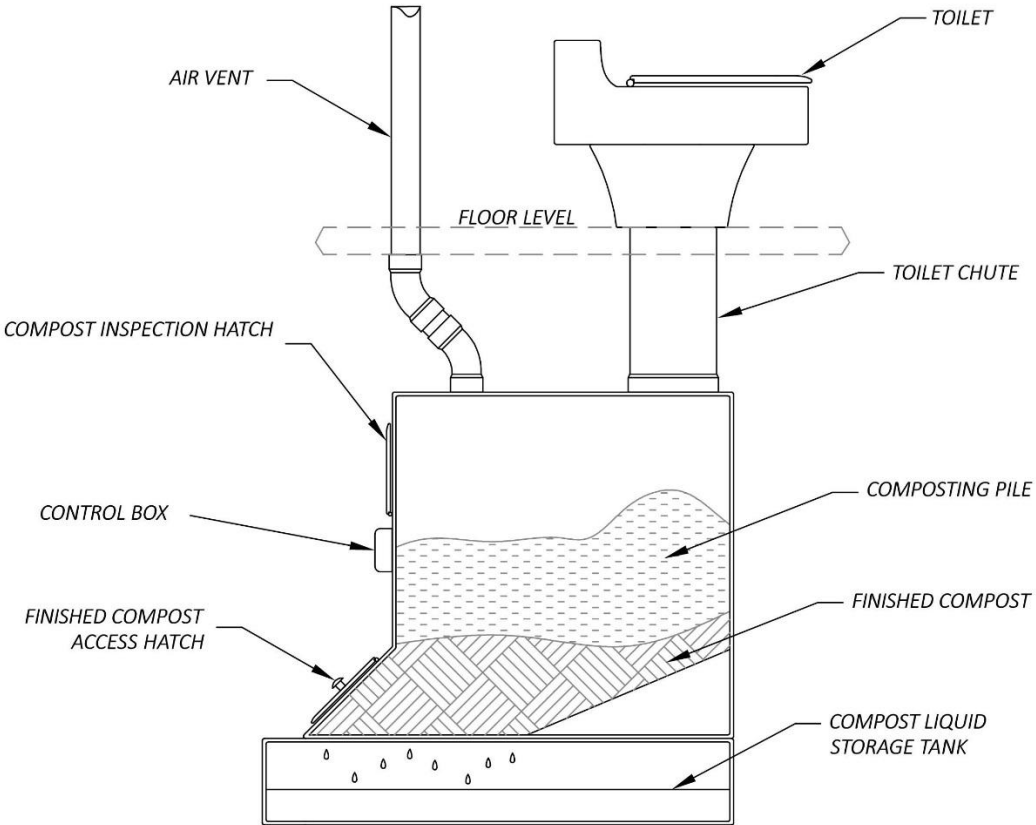

Figure 8.D Standard Grease Trap Detail

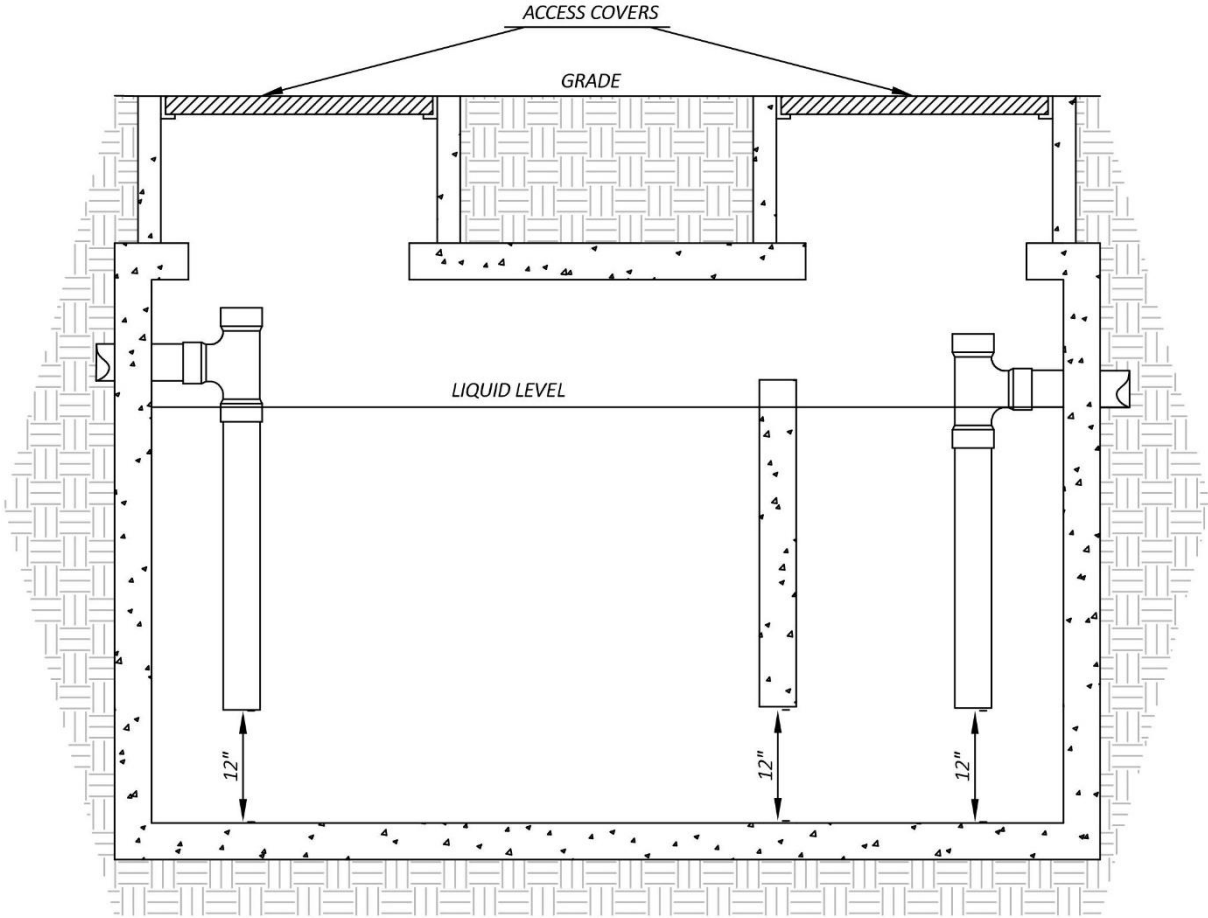

Figure 9.D Septic Tank to Grease Trap Conversion

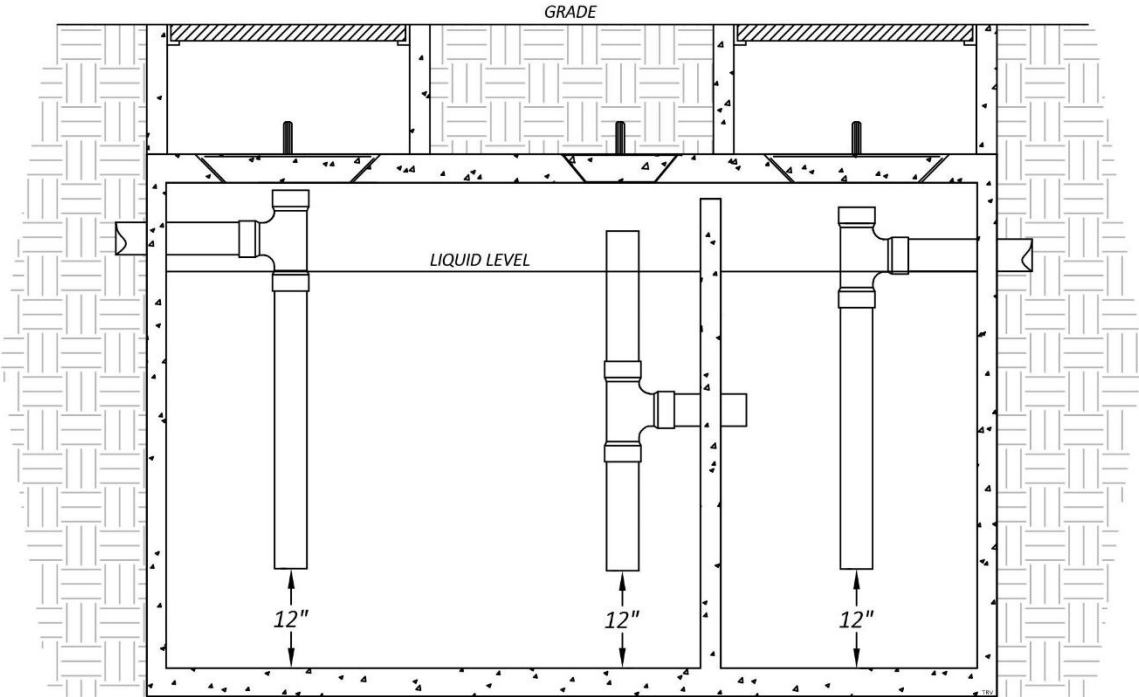
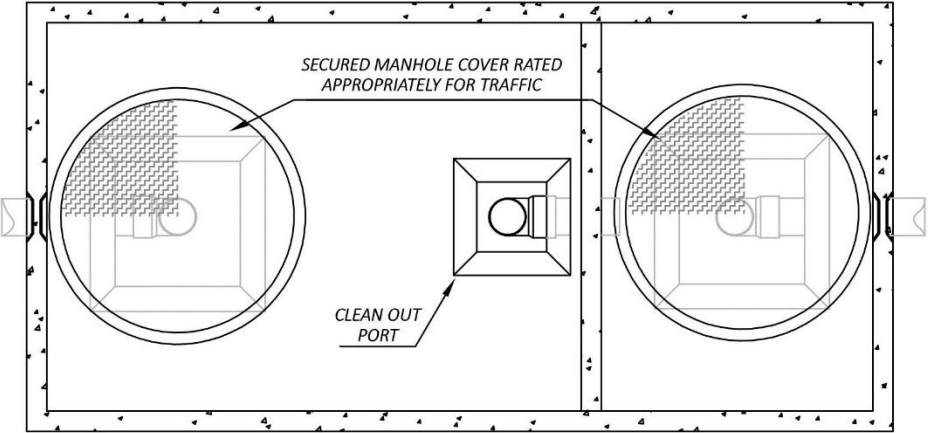
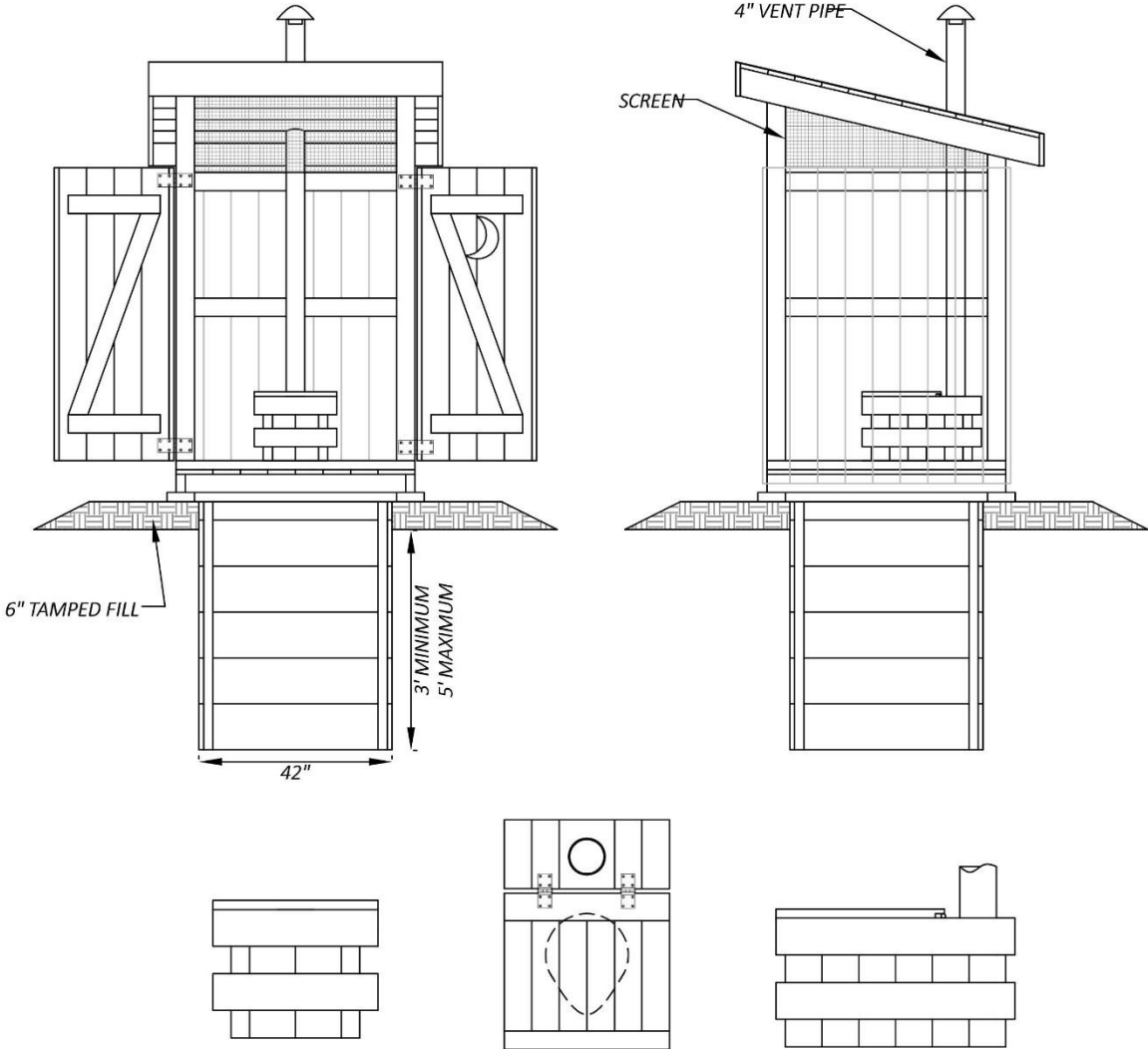

Figure 10.D Pit Privy Design Detail





GEORGIA DEPARTMENT OF PUBLIC HEALTH

# Manual for On-Site Sewage Management Systems

SECTION E | EFFLUENT DISTRIBUTION AND  
DOSING DEVICES

Environmental Health Section

---

## SECTION E - EFFLUENT DISTRIBUTION AND DOSING DEVICES

### 1) Preface

Distribution and dosing devices include distribution boxes, flow splitters, siphons, pumps and other flow diversion devices. These devices shall be of sound construction, water tight and not subject to excessive corrosion. They shall provide sufficient volume to accommodate expected flows.

### 2) Distribution Devices

#### A. Precast Concrete Distribution Box Construction Criteria:

1. *Load Bearing* - All precast concrete distribution boxes shall be designed and constructed to provide sufficient strength and structural integrity to withstand a vertical uniform load of 150 pounds per square foot on the top of the box.
2. *Concrete Strength* - A minimum end product strength of 4,000 pounds per square inch shall be used in the construction of the box and lid.
3. *Concrete Thickness and Reinforcement* - A minimum thickness of one and one-half inches shall be used in the construction of distribution box bottoms, sidewalls, and lids; all shall be reinforced by a minimum # 10 gauge six-inch welded steel reinforcing wire or equivalent.
4. *Lids* - Distribution box lids or covers shall meet the requirements of section 2.A.1 above and shall be provided with suitable handles for removal.
5. *Inlet and Outlet Hole Size* - Knockouts for inlet and outlet piping shall be of sufficient diameter to accept four-inch diameter piping.
6. *Inlet and Outlet Hole Elevations* - The invert of the inlet hole or knockout shall be a minimum of two inches to a maximum of three inches above the invert of the outlet hole.
7. *Inlet and Outlet Hole Dimensions* - The inlet hole or knockout shall be centered left to right. Where multiple outlets are used, they must be located not less than nine inches on center; the outlet (s) shall be not less than three inches from the corners of the box and at least three inches above the inside bottom surface of the box.
8. *Identification* - All distribution devices offered for sale or use in Georgia shall bear the manufacture's name by imprint, stencil or other acceptable means of marking.

#### B. Molded Plastic and Fiberglass Distribution Box Construction Criteria:

1. *Materials* - Distribution boxes shall be constructed of high-density polyethylene (type 3, 0.941 to 0.965 density as provided in ASTM D 3350), fiberglass or other materials acceptable to the Department.
2. *Material Strength* - Distribution boxes shall be constructed of durable watertight materials resistant to deterioration and designed to withstand a vertical uniform load of 150 pounds per square foot on the top of the box. The box shall accommodate a removable lid. The lids will be capable of being secured.

3. *Inlet and Outlet Hole Elevations* - The invert elevation of all outlets shall be the same and shall be at least 1.5 inches below the inlet invert.
4. *Sump Depth* - Each distribution box shall be provided with a sump extending at least two (2) inches below the invert of the inlet.
5. *Identification* - Distribution box covers shall be marked with the manufacturer's business name.
6. *Plans Required* - Each manufacturer shall provide the Department with complete plans and specifications for a given distribution box.

C. *Drop Box Construction Criteria:*

1. *Inlet and Outlet Hole Dimensions* - For concrete drop boxes, the invert of lateral outlet holes or knockouts shall be located with a minimum drop in elevation from the inlet invert of one-half inch; outlet inverts shall be located a minimum of three inches above the inside bottom surface of the box. The inlet or outlet holes or knockouts shall be located a minimum of three inches from adjacent sidewalls.

The requirements in paragraphs B.2 and B.3 below apply to concrete, molded plastic and fiberglass drop boxes.

2. *Inlet and Outlet Hole Elevations* - The centerline of the inlet hole or knockout of drop boxes in series shall be a minimum of five inches above the centerline of the inlet of each successive box.
3. *Design Criteria* - Drop boxes shall be designed to provide sufficient separation distance (12 inches or greater recommended) between the outlet sidewall and supply inlet sidewall of the next box in series.

D. *Molded Plastic and Fiberglass Drop Box Construction Criteria:*

1. *Materials* - Drop boxes shall be constructed of high-density polyethylene (type 3, 0.941 to 0.965 density as provided in ASTM D 3350), fiberglass or other materials acceptable to the Department.
2. *Material Strength* - Drop boxes shall be constructed of durable watertight materials resistant to deterioration, and designed to withstand a vertical uniform load of 150 pounds per square foot on the top of the box. The box shall have a removable lid.
3. *Inlet and Outlet Hole Elevations* - The invert of the inlet and overflow port shall be at the same elevation. The invert of the pipe port (s) leading to the disposal trench (es) shall be at least six (6) inches below the invert of the inlet.
4. *Identification* - Drop box covers shall be marked with the manufacturer's business name.
5. *Plans Required* - Each manufacturer shall provide the Department with complete plans and specifications for a given drop box.

- E. *Plastic Low-Pressure Pipe Manifold Construction Criteria* - All plastic pipe, fittings and connectors used in low-pressure pipe supply lines and manifolds shall be of NSF/ANSI schedule 40 PVC construction and materials.

---

F. *Alternating Valves and Devices Construction Criteria:*

1. *Design Criteria* - Alternating valves and devices shall meet the general design and construction standards listed previously in sections A.1 and A.4 and if constructed of precast concrete, also meet the standards of sections A.2 and A.3 of this subsection.
2. *Valve Requirements* - All alternating valves and devices shall be designed and constructed to provide a positive seal to each outlet when in a closed position. The valving device shall be constructed of corrosion resistant materials and be of sufficient strength to withstand normal operational stresses without damage or deformation resulting in valve malfunction.
3. *Risers Required* - All alternating valves and devices located beneath the soil surfaces shall be fitted with risers and watertight lids or covers, extending to grade, which will permit unobstructed access for maintenance, inspection and operation.

### 3) Dosing Devices

A. *Dosing Tanks*

1. *Description* – Dosing tanks are watertight tanks that store raw or pretreated wastewater for periodic discharge to subsequent treatment units or disposal areas. Pumps or siphons are mounted in the tank to discharge the accumulated liquid and they shall have appurtenant switches and alarms that notify the owner of a malfunction. The structure must be equal to a concrete septic tank in strength. Figure 12.E depicts a septic tank with a dosing tank and siphon. Figure 11.E shows a typical dosing tank with pump.
2. *Application* – Dosing tanks are used where it is necessary to elevate the wastewater for further treatment or disposal, where intermittent dosing of treatment units or subsurface absorption fields is desired or where pressure distribution networks are used. If the dosing tank is at a lower elevation than the discharge point, pumps must be used. If the dosing chamber is at a higher elevation, siphons may be used, but only if the settleable and floatable solids have been removed from the effluent. Dosing tanks shall meet the same setback requirements applicable to septic tanks.
3. *Factors Affecting Performance* – Factors that are to be considered in the design of dosing tanks are: (1) the dose volume; (2) the total dynamic head; (3) the desired flow rate and (4) the wastewater characteristics. When pumps are used, they must be selected based on all four factors. The desired flow rate and the discharge invert elevations determined from the total dynamic head will be the deciding factors for use of automatic siphons.
4. *Dosing Tanks for Conventional Septic Tank System* – A dosing tank shall be provided where more than 500 linear feet of absorption trench is required. The operating liquid capacity of the dosing tank shall be equivalent to 60 to 75 percent of the interior volume of the absorption lines to be dosed. For four-inch diameter absorption lines, the dosing tank operating liquid capacity should be based on one-half gallon per linear foot of absorption line. When more than five hundred linear feet and less than one thousand linear feet of absorption trench is required, a single siphon or pump shall be used (See Figure 13.E). Dosing shall be by automatic siphon or by sewage pump installed in the

dosing tank. When more than 1000 linear feet of absorption trench is required, alternating siphons or pumps shall be used (See Figure 14.E).

5. *Design and Operation of Tank with Siphon* – The action of a siphon is as follows: as the water entering the tank rises above the sniff hole in the bell, it encloses the air within as the lower portion of the trap is being filled with water. As the water level of the tank rises, the pressure of the confined air gradually forces the water out of the long leg of the trap until a point is reached where the air just starts to escape around the lower bend. As the difference of water level in the two legs of the trap equals the difference of the levels between the water in the tank and the water within the bell, it will be seen that the column of water in the short discharge leg of the trap has practically the same depth as the head of the water in the tank above the level at which it stands in the bell. The two columns of water therefore counterbalance each other at a certain fixed depth in the tank. As soon as this depth is increased by a further supply of incoming water, however small, a portion of the confined air is forced around the lower bend; and by its upward rush, carries with it some of the water in the short leg, thus destroying the equilibrium, and the siphon is brought into full action immediately. The water is then drawn out of the tank to the bottom of the bell, the siphon vented by the admission of air through the sniff hole, and the operation automatically repeated. (See Figure 12.E)
6. *Dosing frequency* – Dosing frequency should be determined on a site-specific basis according to the soil characteristics, site conditions, wastewater characteristics and on-site sewage management system design.
7. *Design and Operation of Dosing Tank with Pump (s)* – A dosing tank with a pump (or pumps) consists of a tank, pump, pump controls and alarm systems. Figure 11.E shows a cross section of typical dosing tank used for pumping pretreated wastewater. The tank can be a separate unit as shown, or it can have common wall construction with the pretreatment unit, usually a septic tank. The dosing tank shall have sufficient volume to provide the desired dosing volume plus reserve volume. The reserve volume is the volume of the tank between the high water alarm switch and the invert of the inlet pipe. It provides storage during power outages or pump failure. A reserve capacity equal to the estimated daily wastewater flow is used for residential application. For a single-family residence, this shall mean a minimum of 150 gallons per bedroom. In large flow applications, duplex pump units with alternative power source can be used as an alternative to provide reserve capacity. No reserve capacity is necessary when siphons are used. Pump selection is based on the wastewater characteristics, the desired discharge rate and the total dynamic head. Raw wastewater requires a pump with solids-handling capabilities. While pneumatic ejectors may be used in other applications as well, submersible centrifugal pumps are best suited where large volumes are to be pumped in each dose. The pump size is determined from pump performance curves provided by the manufacturers. Selection is based on the flow rate needed and the total dynamic head. The specific application determines the flow rate needed. The total dynamic head is calculated by adding the elevation difference between the discharge outlet and the lowest water level in the dosing tank to the friction losses incurred in the discharge pipe. The velocity head can be neglected in most applications. If the liquid pumped is to be free of suspended solids, the pump may be set on a pedestal. This provides a quiescent zone below the pump where any solids

entering the tank can settle, thus avoiding pump damage or malfunction. These solids must be removed periodically. In cold climates, where the discharge pipe is not buried below the frost line, the pipe should be drained between doses. This may be done by sloping the discharge pipe to the dosing tank and eliminating the check valve at the pump. In this manner, the pipe is able to drain back into the dosing tank through the pump. The dosing volume is sized to account for this backflow. Weep holes may also be used if the check valve is left in place. The control system for the dosing tank consists of a “pump off” switch, a “pump on” switch and a “high water alarm” switch. The “pump off” switch is set several inches above the pump intake. The “pump on” switch is set above the “pump off” switch to provide the proper dosing volume. Several inches above the “pump on” switch, a high water alarm switch is set to alert the owner of a pump malfunction by activating a visual and audible alarm; this switch must be on a circuit separate from the pump switches (see Figure 11.E). The electrical connections should not be located inside the tank or riser. Pump failures can usually be traced to switch failures resulting in pump burnout; so high-quality switches are a good investment. Some types are: Mercury, Pressure Diaphragm, Weighted Float and Dual or Multiple Function.

#### 4) Pumps and Ancillary Equipment

Pumping of sewage effluent can cause problems if the right pump is not used. The pump can burn or clog if it pumps the wrong substance. Therefore, choosing the right pumps for on-site sewage management operations is critical.

##### A. Pumps

1. *Submersibility* - The pump shall be submersible.
2. *Wastewater Capability* - The pump shall be designed to handle sewage effluent.
3. *Discharge Pipe Size* - The pump shall be capable of delivering the required flow at the design total dynamic head. The discharge pipe shall be the same size or larger than the discharge of the pump.
4. *Materials* - The pump shall be constructed of corrosion resistant materials.
5. *Performance Specifications* - Performance curves and specification sheets indicating the above criteria have been met shall be submitted with the plan review application when pumps are to be used in a system.
6. *Minimum Pipe Sizes* - In order to ensure sufficient fluid velocity to carry any solids present in the septic effluent (generally accepted velocity is at least two feet per second), the following pipe sizes are required: 1 ½” pipe with flows of at least 12 gallons per minute (gpm); 2” pipe with 21 gpm; 2 ½” pipe with 30 gpm; and 3” pipe with 46 gpm.
7. *Backflow Prevention* - A backflow prevention device shall be used on the discharge line where conditions allow, reducing wear on the system.

8. *Piping Materials* - Pipe materials must be schedule 40 PVC, all fittings shall be pressure fittings, and all connections shall be adequately cleaned with cleaning solvent and glued with PVC solvent cement.
9. *Valve Requirements* - If used, the gate or globe valve (s) and check valve shall be either bronze or PVC.
10. *Siphon Prevention* - The discharge line shall be designed and installed to drain after each use unless system design requires a check valve. See subsection 3) A.7 above.

B. *Ancillary Equipment*

1. *Quick Disconnect* - A quick disconnect device shall be included in the discharge piping to facilitate removal of the pump for inspection, repair or replacement.
2. *Pump Extraction Device* - A corrosion resistant rope or cable of adequate strength shall be affixed to the pump to facilitate installation and removal, so that personnel need not enter the chamber to disconnect the pump.
3. *Pump Control Devices* – A pump control device must be adjustable so that the desired dosing volume can be discharged during each pumping cycle. The control device may consist of one or more sealed float or diaphragm switches, which may cooperate with a relay or contactor. Separate control panels located outside the pump tank must be protected from the weather and must provide no air path between the panel and the pump tank.
4. *Security* – For safety, access covers for the pump tank must be lockable, heavy enough to prevent easy access or equipped with tamper-proof retainers. Access must be of adequate size and accessible from the surface to allow for installation and removal of equipment and to maintain the system. Foremost, the pump tank must not allow infiltration or exfiltration.
5. *Separate Circuits* - The alarm switch must be placed on a circuit separate from the pump switches.
6. *Electrical Requirements* - All wiring and components of the whole system shall conform to the National Electrical Code.

5) Tables, Figures and Forms

Figure 11.E Typical Dosing Tank with Pump

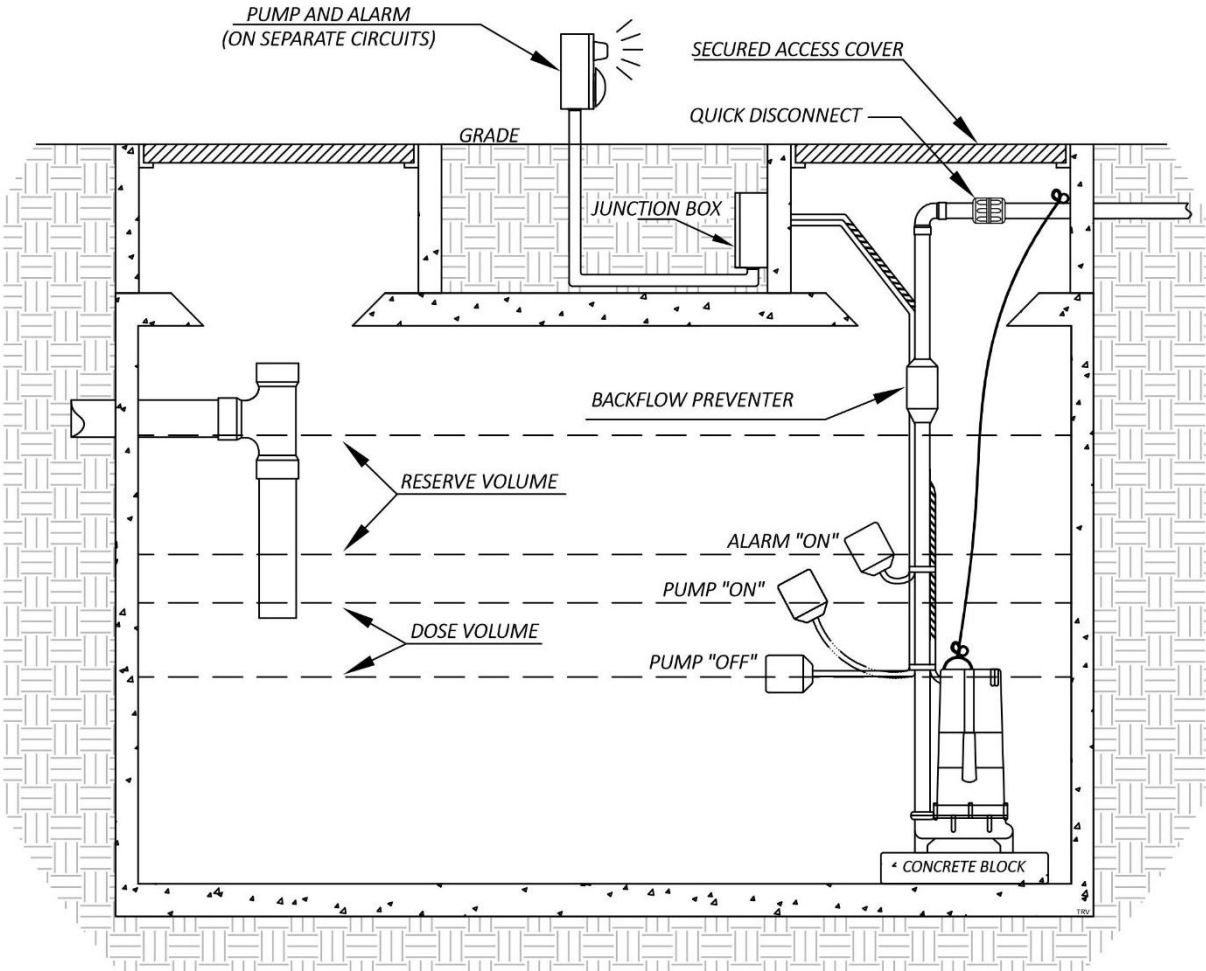
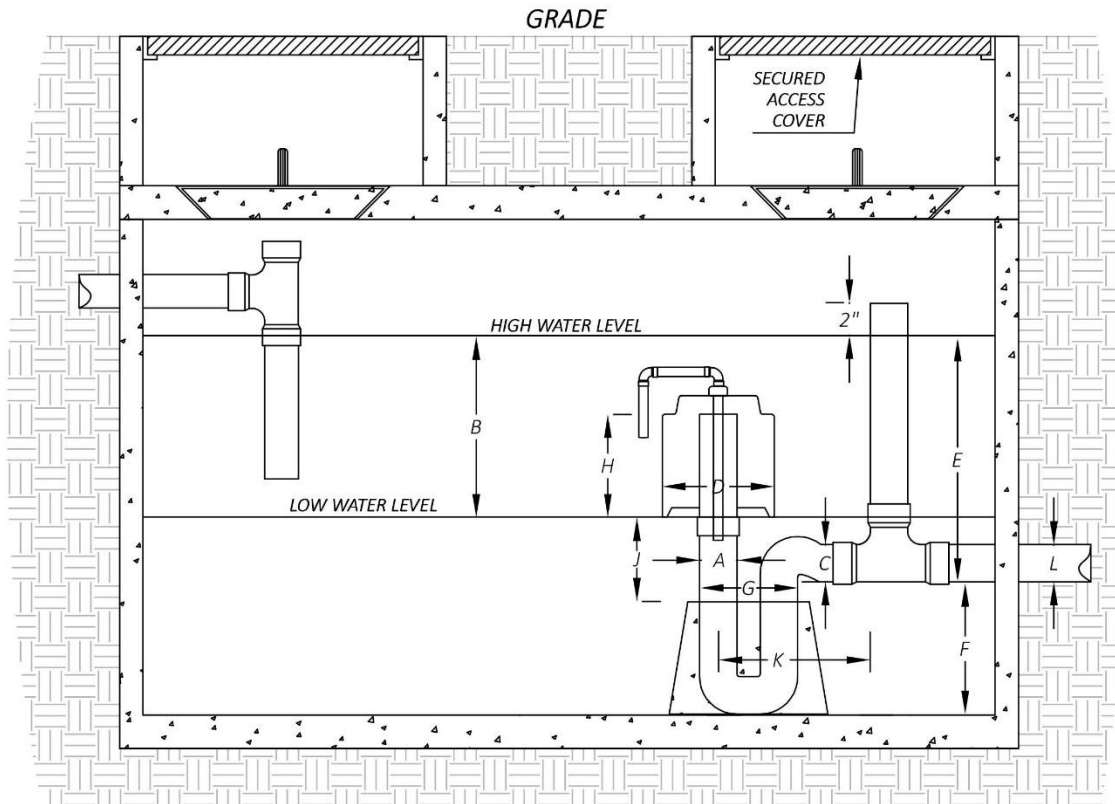

Figure 12.E Sewage Siphon



Sewage Siphon Dimensions (in inches)						
Diameter of Siphon	A	3	4	5	6	8
Draw Depth	B	13	17	23	30	35
Diameter of Discharge Head	C	4	4	6	8	10
Diameter of Bell	D	10	12	15	19	24
Invert Below Floor	E	4 ¼	5 1/8	7 1/8	10	12
Depth of Trap	F	13	14 ¼	23	30 ¼	35 ½
Width of Trap	G	10	12	14	16	22 ½
Height Above Floor	H	7 ¼	11 ¾	9 ½	11	13 ½
Invert to Discharge	I	20 ¼	25 ½	33 ½	44	52
Bottom of Bell to Floor	J	3	3	3	4	5
Center of Trap to End of Discharge	K	8 1/8	11 ¾	15 1/8	17 ½	23 1/8
Diameter of Carrier Pipe	L	4	4-6	6-8	8-10	12-15
Average Discharge Rate – GPM		72	165	328	472	950
Maximum Discharge Rate – GPM		96	227	422	604	1270
Minimum Discharge Rate – GPM		48	102	234	340	698

Figure 13.E Criteria for Drainfields 500 to 1000 Feet

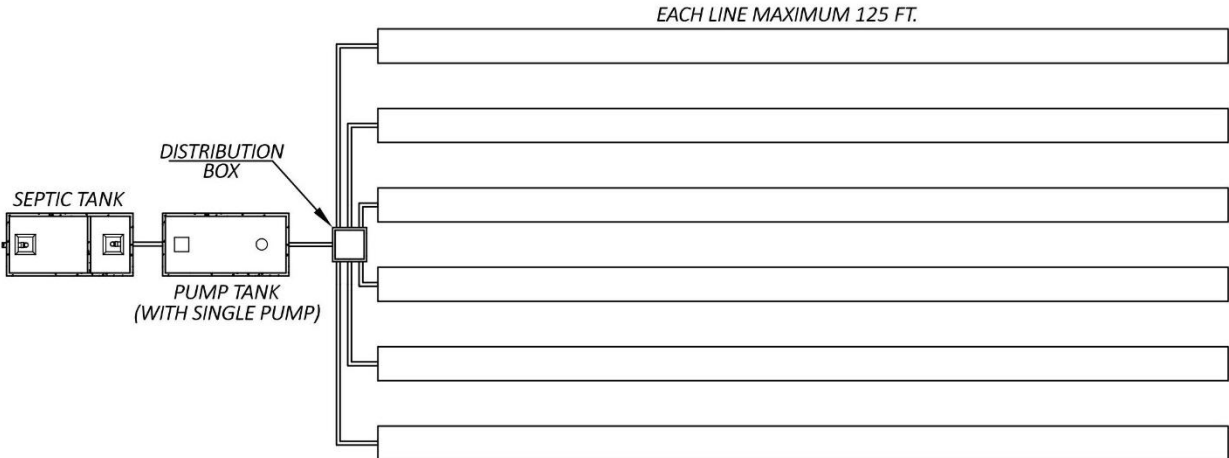
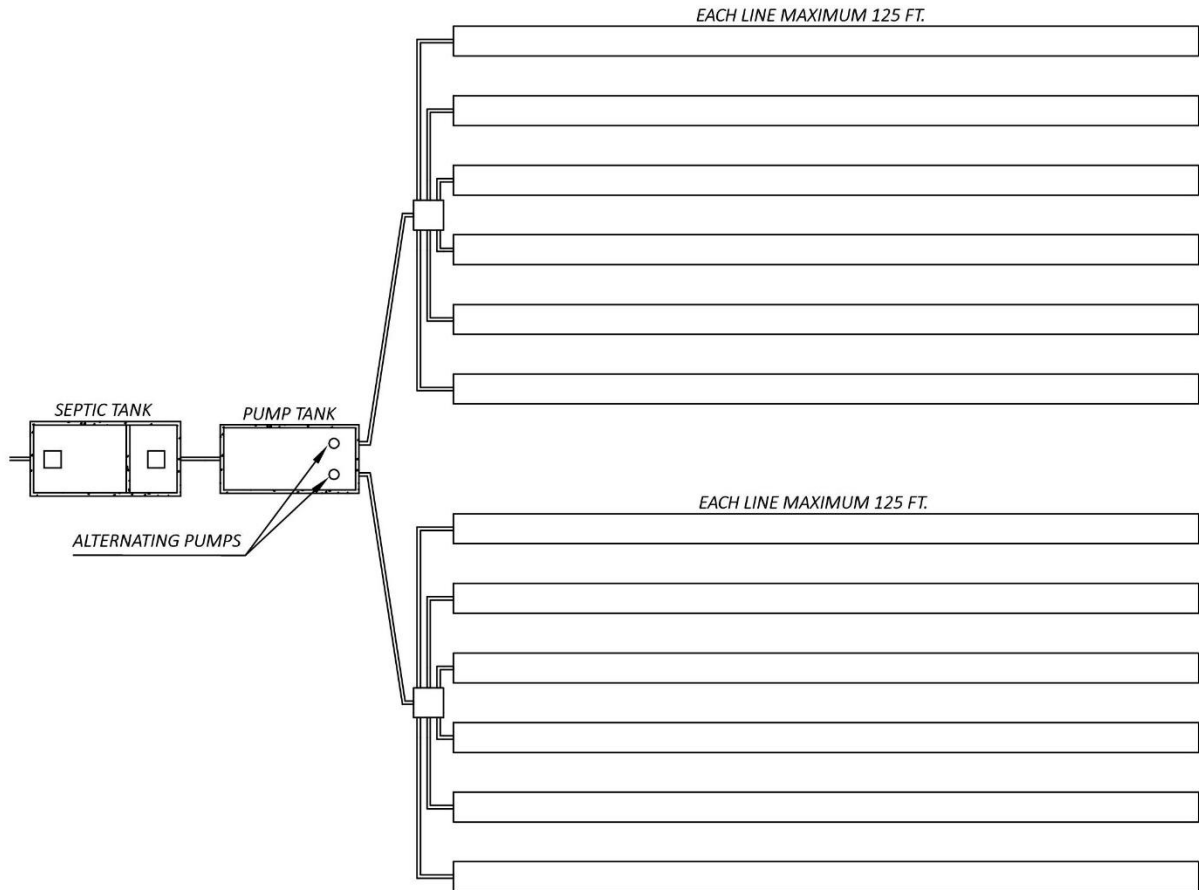

Figure 14.E Criteria for Drainfields >1000





# Manual for On-Site Sewage Management Systems

## SECTION F | DISPERSAL SYSTEMS

Environmental Health Section

## SECTION F – DISPERSAL SYSTEMS

### 1) Preface

Subsurface dispersal systems are portions of on-site sewage management systems that accept effluent from sewage pretreatment units for further treatment by microbial life within the soil. Treatment also occurs by filtration, chemical decomposition and chemical bonding within the soil itself. These systems consist of:

- A. Devices and piping to transport effluent under pressure or by gravity flow and distribute the effluent to the soil absorption surfaces;
- B. Trenches, chambers, mounds, drip emitter lines and others, separately or in combination, which form or enclose the soil absorption surfaces; and
- C. Rock, gravel, peat or other fill materials required within the system including barrier materials and fill soil within or over the system.

### 2) Aggregate Absorption Field Systems

- A. *Conventional Septic Tank System* – This means a septic tank and absorption field system composed of perforated pipe surrounded by gravel or stone masking for the infiltration of effluent into the adjoining bottom and side soil areas. The Department’s Technical Review Committee may recommend approval of other types of aggregate for use in conventional septic tank systems.
- B. *Location* – Absorption fields shall be installed in areas protected from excessive surface water, ponding or runoff, including but not limited to storm water and discharge from building gutters. Absorption fields shall not be installed where slopes exceed 25% unless the results of special investigations demonstrate that the slope limitation can be overcome by design or site modification. Any site modification plan must be approved by the local County Board of Health prior to modifications being carried out. There shall be a minimum of 24 inches of vertical separation from the absorption field trench bottom to any seasonal groundwater table, rock or impervious soil layer. Greater vertical separation distances may be required if special investigations indicate a potential for groundwater contamination. On lots or parcels of land less than 3 acres, the maximum percolation rate shall not exceed 90 minutes per inch.

If properties are served by individual water supply systems, the absorption field shall be installed not less than 50 feet from property lines unless wells and on-site sewage management systems are already in place on surrounding property and the required 100 feet separation distance between wells and absorption fields can be maintained. In pre-planned developments, where sites for individual water supplies and on-site sewage management systems are pre-located so as to maintain the 100 feet separation distance, absorption fields may be installed less than 50 feet, but not less than five feet from property lines. No part of the absorption field other than solid schedule 40 PVC or equivalent pipe with watertight joints shall be covered by buildings, pavements, or used for parking automotive vehicles or vehicular traffic. There shall be available sufficient unobstructed land area, meeting all requirements for the installation of an on-site sewage management system, to provide for the complete replacement of the absorption field. If

topographical features permit, this requirement can be met by installing the initial absorption trenches on 16 feet centers, thus allowing for replacement between the original trenches.

Unless ordinances adopted by the local government responsible for the criteria contained in the Rules of the Georgia Department of Natural Resources, Environmental Protection Division, Chapter 391-3-16-.01-Criteria for Water Supply Watersheds (hereafter Chapter 391-3-16-.01) indicate otherwise, the following setbacks shall apply to septic tanks and absorption fields: septic tanks and absorption fields are prohibited within 150 feet of any perennial stream bank in a large water supply watershed tributary that is upstream to a water supply reservoir of a governmentally owned public drinking water supply intake and within a seven-mile radius of the reservoir boundary. In a small water supply watershed: septic tanks and absorption fields are prohibited within 150 feet of any perennial stream bank upstream of a small water supply reservoir of a governmentally owned public drinking water supply intake within a seven mile radius of the intake or water supply reservoir; additionally these are further prohibited within 75 feet of any perennial stream bank upstream and outside the seven mile radius within the small water supply watershed as required by Chapter 391-3-16-.01.

Absorption fields may not be installed in the 100 feet buffer area of rivers classified for protection under the Rules of the Department of Natural Resources, Environmental Protection Division, Chapter 391-3-16-.04 *Criteria for River Corridor Protection*.

C. *Minimum Design and Construction Criteria:*

1. Absorption lines and absorption trench bottoms shall be true to grade.
2. Trench bottom depth shall be based on soil conditions as determined by criteria in this Manual.
3. A minimum of six to twelve inches of earth cover is required over absorption lines.
4. Absorption line laterals shall be spaced a minimum of seven feet apart, center to center.
5. Absorption trenches shall be no more than 36 inches wide.
6. The minimum depth of aggregate shall be twelve inches with six inches below the perforated pipe and filled to two inches above the pipe.
7. Perforated pipe shall be laid in the center of the trench with the perforations oriented toward the bottom of the trench.
8. A layer of pervious building paper, straw or similar permeable material approved by the Technical Review Committee shall be placed over the aggregate before back filling.
9. Approved solid pipe and fittings with sealed, watertight joints shall be used for horizontal and vertical changes in direction or grade and to cross under roadways or paved areas. Sections of solid pipe shall not be considered in determining the total absorption trench bottom area.
10. Excavation for absorption trenches in soils other than sands shall not be conducted when wet due to the potential irreversible damage to soil structure, such as compaction and smearing.

**D. Perforated Pipe – Gravity Flow Usage:**

1. All perforated pipe used for gravity flow carriage and distribution of effluent within lateral trenches, mounds or other such applications shall meet 1,500 lb crush strength in accordance with ASTM - F810 standards for rigid piping and ASTM – F667 for corrugated semi-rigid piping.
2. Each standard section of pipe as supplied by the manufacturer shall be plainly marked, embossed or engraved showing the manufacturer’s name, the type of pipe material and showing the product meets applicable ASTM standards and a bearing load of 1,500 lbs. per foot. In addition, a painted or other clear line shall be marked on each section of pipe to denote the top.
3. For conventional systems, all gravity flow usage perforated pipe shall have a minimum internal diameter of four inches.
4. All four-inch diameter or greater pipe shall have at least two rows of holes between ½ inch and ¾ inch in diameter, evenly spaced and placed within an arc of 120 degrees on the bottom of the pipe with a third hole of same size being directly opposite the top marking. Spacing of holes longitudinally shall be every 4 inches on centers along the length of the pipe.

**E. Absorption Field Sizing:**

1. The absorption field area shall be based upon the anticipated peak daily volume of treated sewage, waste stream characteristics and the characteristics of the soil in the absorption field location.
2. Prior to application to the soil, the waste stream must have a BOD5 and TSS of 200 mg/l or less. In addition, grease generating facilities shall reduce the fats, oil and grease content of their waste stream to 25mg/l prior to application to the soil.
3. Soil absorption rates shall determine the absorption trench bottom area of the absorption field.
4. Sewage flow rates for individual residences shall be based on the number of bedrooms. Table 10.F relates bedrooms to absorption rates for determining the absorption field trench bottom area required.
5. Sewage flow rates for other facilities shall be based on criteria in Section J of this Manual. Absorption field trench bottom area for other facilities shall be based on the below formula.

**Formula for Sewage Flow Rates for Non-Residential Facilities**

$$\frac{\text{percolation coefficient } (\sqrt{t}/5) \times \text{gallons per day}}{\text{trench bottom width (feet)}} = \text{Linear feet}$$

**3) Absorption Field Methods for Conventional Septic Tank Systems**

- A. *Distribution Box Method* – On level or sloping topography, the distribution box method may be used and shall be required when dosing tanks are used. A firm earthen foundation secured by concrete or concrete foundation for distribution boxes extending at least 12 inches beyond the walls of the box shall be provided to insure against tilting of the distribution box. Installation of the distribution box shall be made to provide equal flow to

each absorption line extending from the box. The top of the distribution box shall have a minimum earth cover of six inches, but no more than twelve inches unless provisions are made for easy access to the distribution box. The sewer from the septic tank or dosing tank shall enter the distribution box and terminate inside the distribution box with an elbow turned downward to form a submerged outlet at normal water level to minimize turbulence. Alternately, a baffle may be used if the same function is accomplished. Absorption lines of equal length shall be connected to the distribution box outlets by watertight independent sewers consisting of four-inch schedule 40 PVC pipe or equivalent. All independent sewer lines shall be installed level at the same elevation for two feet. Beginning two feet from the distribution box to the beginning of the absorption line, independent sewer lines shall be installed to provide a minimum downward grade change of two inches from the distribution box outlet to the perforated pipe at the beginning of the absorption line. Absorption lines shall be installed level or on a uniform grade of no more than four inches of fall for the entire length of the individual absorption line. Absorption lines from distribution boxes used in conjunction with dosing tanks shall not exceed 125 feet in length (See Figure 15.F).

- B. *Level Field Method* – On level or sloping topography of five percent or less, the level field method may be used. When this method is used, the absorption field shall be installed level, with all absorption lines interconnected to form a continuous system. A standard tee fitting or approved distribution device shall be used to interconnect the absorption lines. When this method is used, the invert of the absorption line shall be at least six inches lower than the invert of the septic tank outlet. An absorption field consisting of a single absorption line up to 125 feet in length may be installed level without interconnection (See Figure 16.F).
- C. *Serial Distribution Method* – On sloping topography, the serial distribution method may be used. When this method is used, level absorption trenches shall be constructed parallel along the ground contours. The sewer from the septic tank shall enter the uppermost absorption line and terminate at any point in the line so all effluent from the septic tank is discharged into the first absorption line. Adjacent absorption lines shall be successively connected by means of overflow sewers constructed at any point along the absorption line in such a manner that each absorption trench fills with effluent to the full depth of the aggregate before the effluent flows through the overflow sewer to the next trench. The invert of the first overflow sewer must be at least four inches lower than the invert of the septic tank outlet. At the point an overflow sewer leaves an absorption trench, the excavation for the overflow sewer shall be dug no deeper than the top of the aggregate in the absorption trench, so that a minimum 12-inch undisturbed block of earth will remain in place for the full depth of the aggregate. Overflow sewers shall be laid on undisturbed earth with a minimum earth cover of six inches. All pipe and sewer fittings shall be NSF International schedule 40 PVC or equivalent (See Figure 17.F).
- D. *Alternating Field Method* – When the soil percolation rate is over 60 minutes per inch, but less than 90 minutes per inch or soil evaluation reports indicate the absorption rate to be between 60 and 90 minutes per inch, an alternating absorption field system may be considered. If used, the total absorption field area required by the percolation rate shall be divided into two equal but separate systems (See Figure 18.F). A diversion device shall be used to divert sewage flow from one field to the other (See Figure 18.F). Each field should be utilized for one year before diverting flow to the alternate field so as to give each field a satisfactory resting period, unless the field receiving the flow becomes saturated before

one year's use. In the case of saturation of one field, the flow should be immediately diverted to the other field.

The diversion device shall be constructed of materials designed to resist corrosion and shall be accessible to the surface for routine service. See Section E.2.F

- E. *Pressure Distribution Systems* – When the soil percolation rate or soils information indicate that the absorption rate of the soil is between 60 and 90 minutes per inch, pressurized dosing of the absorption field may be considered. This involves the installation of a septic tank followed by a pump tank fitted with a sewage effluent pump to periodically pump the sewage into an absorption field and reduce the problem of saturated soil at the point of discharge.

To achieve uniform distribution, the volume of water passing out of each hole in the network during a dosing cycle must be nearly equal. To achieve this, the pressure in each segment of pipe must also be nearly equal. This is accomplished by balancing the head losses through proper sizing of the pipe diameter, hole diameter and hole spacing. Thus, approximately 75% to 85% of the total head loss incurred is across the holes in the lateral, while the remaining 15% to 25% of head loss is incurred in the networks. These usually consist of one to 3-inch (3-to 8-cm) diameter laterals, connected by a central or end manifold of larger diameter (See Figures 20.F and 21.F). The laterals are perforated at their inverts with  $\frac{1}{4}$  to  $\frac{1}{2}$  inch (0.6 to 1.3 cm) diameter holes. The spacing between holes is 2 feet to 10 feet (0.6 to 3.0 m).

1. Pumps are used to pressurize the network, although siphons may be used if the dosing tank is located at a higher elevation than the lateral inverts. The active dosing volume is about ten times the total lateral pipe volume. This ensures more uniform distribution since the laterals, drained after each dose, must fill before the network can become properly pressurized. (See Section E for Dosing Tank Design).
2. To simplify the design of small pressure distribution networks, refer to the tables and figures in Section O.

- F. *Perforated Pipe – Pressure Usage, Low Pressure Pipe Systems:*

1. Pipe used for pressure carriage and distribution of effluent within lateral trenches, mounds or other low-pressure pipe (LPP) applications shall be of at least 160 psi PVC construction. Deep hub water line shall be used.
2. Each standard section of pipe as supplied by the manufacturer shall be plainly marked, embossed or engraved showing the manufacturer's name or hallmark, the 160 psi designation and the type of pipe material.
3. All such pipe used on an individual LPP system installation shall be of the same type. Material-mixing of PVC, polyethylene or other equivalent piping is prohibited.
4. Minimum pipe internal diameter shall be determined on a case-by-case basis, based upon system size, configuration and other factors necessary in the design of a low-pressure pipe system.
5. Pipe perforations shall run in a straight line along the bottom of the pipe. Where pre-perforated pipe is unavailable, perforations shall be hand-drilled, and deburred. Hole diameters and hole spacing shall be determined on a case-by-case basis relative to design requirements of the low-pressure pipe system.

#### 4) Chamber Systems

- A. *Chamber Systems* - means a system of chambers with each chamber being a molded polyolefin plastic, arch shaped, hollow structure with an exposed bottom area and solid top and louvered sidewall for infiltration of effluent into adjoining bottom and sidewall soil areas. Chambers may be of different sizes and configurations to obtain desired surface areas.

The first step in designing any sewage disposal system is to conduct a thorough site evaluation as covered in other sections of the Manual. Once the feasibility of a septic system is confirmed, the next step is to determine the appropriate size of the system as specified in the current Manual. Chamber systems may then be equivalently sized according to manufacturers' recommendations and per approval by the Department.

Chamber leaching systems provide flexibility and may be adapted to most design situations including equal distribution, serial distribution, pump-up design, cut and fill, at-grade systems and mounds. Installation instructions for various chambers will be based on specific manufacturer's recommendations, which have been reviewed by the Technical Review Committee and approved by the Department. There must be a totally separate absorption field replacement area equivalent in size to 100% of the chamber field installed or a conventional absorption field, whichever is larger.

- B. *Standards for Chamber Systems* - All chambers must be designed and constructed to meet the following minimum standards:
1. Metal chamber systems are prohibited.
  2. Support vertical uniform loading of 600 lb/sq.ft on the top of the chamber without damage or permanent deformation, meeting American Association of State Highway and Traffic Officials load rating H-10 (16,000 lbs/axle);
  3. In non-vehicle traffic areas, chambers may be approved for installation with a final soil cover of 6 inches provided the chambers in the final installed configuration are capable of supporting a 4,000 lb/axle load without collapsing, fracturing, or breaking. The chamber must be capable of supporting a temporary construction loading of 16,000 lbs/axle (American Association of State Highway and Transportation Officials H-10 load) without collapsing, fracturing or breaking. Additional soil cover above the final grade may be used to bridge this load during construction.
  4. Provide ports, slots or other similar openings on sidewalls to allow air movement and effluent access to lateral field trench sidewall absorption surfaces;
  5. Interlock to allow serial installation of chambers, and be provided with acceptable end plates, caps or other necessary fittings and connectors;
  6. All chambers shall be designed to accommodate at least one inspection port of a minimum internal dimension of four inches centrally located in the top of the chamber;
  7. All such chambers offered for sale or use in Georgia shall bear, by imprint, stencil or other acceptable means of permanent marking, the manufacturer name and product identification number assigned to the chamber plans and specifications; this shall be located in an easily visible location on each chamber.

#### 5) Wisconsin Mound Soil Absorption System

The Wisconsin mound wastewater soil absorption system was developed in the early 1970's to be used on sites with specific site characteristics where in-ground gravity flow trench or bed soil absorption systems were restricted. The Wisconsin mound system has been widely accepted and incorporated in many state regulations. It is one of several systems suitable for treating and disposing of the wastewater generated in residential and commercial units and is not suited for all sites.

The objectives are to treat and dispose of the wastewater via the subsurface in an environmentally acceptable manner and to protect the public health.

The concept of an elevated on-site system for sewage disposal was developed in the 1950's (Witz, 1974). In the 1970's, significant modifications were made to overcome many system limitations (Converse et al., 1975 a, b, c.; Machmeier, 1977; Carlile et al, 1977). Figure 22.F is a cross section of a Wisconsin mound system. It consists of a septic tank, a dosing chamber and the mound. As with other soil absorption systems, the septic tank removes most of the settleable solids and is a place for liquefaction of the more easily biodegradable solids. The dosing tank contains a pump or siphon, which pressurizes a distribution network of small diameter pipe with small perforations and distributes the septic tank effluent uniformly along the length of the mound. The purpose of the mound is to accept septic tank effluent, and along with the native soil, treat and purify the wastewater to acceptable standards. The mound consists of a layer of suitable sand, aggregate, distribution system and soil cover. Originally, the Wisconsin mound system was designed for individual homes with specific soil and site limitation and with wastewater flows of less than 750 gpd (Converse et al., 1975 a, b, c; Converse 1978). As the need for disposal of wastewater on sites where below grade systems were not appropriate and for disposal of greater wastewater volumes from small communities, clusters of disposal of homes and commercial establishments increased, the demand for the Wisconsin mound system on these sites has increased. It is not unusual to see Wisconsin mound systems receiving wastewater flows in excess of 25,000 gpd. Evaluation of mounds on sites with more restrictions than currently allowed in most codes has resulted in utilizing mounds on more difficult sites. (Converse and Tyler, 1986a; 1986b). Based on the experience of siting, design and construction, concepts have been modified (Tyler and Converse, 1985; Converse and Tyler, 1987). The purpose of this Manual is to consolidate these concepts and present the latest siting, design and construction criteria of the Wisconsin mound system.

A. *Siting Criteria* – A designer of on-site wastewater treatment and disposal systems must have a basic understanding of water movement into and through the soil especially on more difficult sites. This understanding is based on information collected during the site evaluation. The siting of the system and loading rates can be no better than the information used. Figure 24.F shows a schematic of effluent movement within and away from mound systems under various soil profiles. Depending on the type of profile, the effluent moves away from the site vertically, horizontally or a combination of both. It should be noted that these concepts are true for all soil absorption systems. The sizing and configuration of all soil absorption systems, including the mound, is based on how the effluent moves away from the system and the rate at which it moves away from the system. Thus, the designer must predict that movement and rate of movement or the design may be flawed and the system may fail. The prediction is made based on soil and site information obtained during site evaluation.

The siting and design concepts presented in this publication and elsewhere (Converse, et. Al. 1989, and Tyler and Converse, 1986) results in soil absorption systems that are usually long and narrow. The more restrictive the site, the narrower and longer the soil absorption system must be. If these concepts are not followed, then the system may not perform as expected. It should be noted that these concepts will not apply to all soil and site situations, as soil absorptions systems are not compatible to all sites and should not be used on such sites.

Codes regulating on-site subsurface disposal of wastewater require a suitable depth of soil to treat the effluent before it reaches the limiting condition; such as bedrock or high water table, or a slowly permeable soil layer. Figure 19.F shows the relationship between the type of system that may be best suited and the location of the limiting condition beneath the ground surface, utilizing a 2 ft suitable soil separation distance. This suitable depth of unsaturated soil varies among codes but usually is between 1 and 4 ft. For the mound system, this suitable depth consists of the distance from the ground surface to the limiting condition below the ground surface, plus the depth of sand between the ground surface and the infiltrative surface within the mound (normally the aggregate/sand interface or the exposed surface of chamber units). For the at-grade system, the suitable depth is from the ground surface to the limiting condition (Converse et al., 1989). For example, if the code required 2 ft of suitable soil and the site distance was greater than two feet but less than required for an in-ground system, an at-grade system would be better suited than a mound system for the site. However, if this distance was less, then a mound system may be most appropriate.

This Manual does not provide methods and procedures for describing and interpreting soil and site conditions used to determine suitability and design parameters for a Wisconsin mound. A Soil Classifier or other qualified soil evaluator should be employed to provide site descriptions and interpretations. It is best if the Soil Classifier works with the designer and installers to insure proper use of the site.

Table 5.F gives soil and site criteria for the Wisconsin mound based on research and field experience. When the mound was originally developed in the 1970's, the criteria were conservative as there was very little experience with mound systems. Since that time, considerable research has been conducted on more difficult sites (Converse and Tyler, 1985, 1987). Care must be taken when using these criteria as they are for the most difficult sites utilizing on-site systems. Design configuration, loading rates and construction are very critical for the successful functioning of the systems.

1. *Depth to High Water Table* – High ground water table, including seasonally perched water table, should be greater than about 10 inches beneath the ground surface. High water table is determined by direct observation and/or interpretation of soil mottling. Since it is impossible to detect soil mottles in black surface horizons, it is difficult to determine the exact location of seasonal saturation during wet periods. At some sites during wet periods, saturation may occur at the sand/soil interface at the toe of the mound as the effluent is restricted from moving away from the mound. This effluent is usually extremely low in fecal bacteria but has high nitrates and chlorides (Converse and Tyler, 1985; 1987). Under these saturated conditions, there is the possibility of leakage of this water from the toe of the mound for a few days during seasonal saturation of the soil.

2. *Depth to Bedrock* – Bedrock should be classified as crevice, non-crevice semi-permeable or non-crevice impermeable. Two feet of natural soil depth is suggested for the crevice bedrock as it is assumed that very little treatment takes place in the crevice bedrock. The natural soil aids in the treatment of the effluent and the extra foot of natural soil acts as a factor of safety as the first water table that the effluent will contact may be permanent and potable. Potable water is usually separated from seasonal water table; therefore, shallower depths are required for the non-crevice bedrock as the potential for ground water contamination is much less. In the non-crevice, very slowly permeable or impermeable bedrock, the effluent flow will be horizontal. In the semi-permeable sandstones, the flow will be both vertical and horizontal.
3. *Soil Permeability* – Most codes have used the percolation test to size the soil absorption system. The percolation test is empirically related to the loading rate and it has been shown that the percolation test is very variable. Loading rates should be based on soil texture, structure and consistence with the percolation test, if required, to confirm morphological interpretations. This approach requires more detailed site evaluation and will be used for mound design and siting. Table 6.F gives the design soil loading rates based on morphological interpretations.
4. *Slope* – Mound systems on steep slopes with slowly permeable soils should be narrow to reduce the possibility of toe seepage. Slope limitation is primarily for construction safety. It is very difficult to operate equipment on such steep slopes and installers should be warned about the construction hazards.
5. *Filled Sites* – Fill is defined as the soil placed on a site to raise the elevation of the site. Typically, it is placed on top of the natural soil and may consist of soil with textures ranging from sand to clay or a mixture of textures. During placement soil structure is destroyed and the soil is usually compacted. Under these circumstances the permeability of the soil is reduced and variable. Thus, if a system is to be placed on the site, sufficient time must pass to allow the soil structure to develop and compaction to be reduced via warm and/or freeze/thaw activity. A more intensive soil evaluation must be done because of the variability encountered in filled sites over naturally occurring sites. Many more observation locations are generally needed for filled sites compared to non-filled sites.
6. *Over Old Systems* – Mounds have been successfully placed over failing in-ground soil absorption units. The soil above the system has been disturbed and must be treated as a filled site when evaluating the soil for loading rate. A more detailed evaluation of the effluent movement must be done especially if a mound is placed over a large in-ground system.
7. *Flood Plain* – It is not recommended to install any soil absorption system in a flood plain, drainage ways or depressions unless flood protection is provided.
8. *Horizontal Separation Distances* – The same separation distances between the mound and the respective site features that apply for in-ground systems should apply for the Wisconsin mounds. On sloping sites, the upslope and end distances should be measured from the upslope edge or ends of the aggregate to the respective features and the down slope distance should be measured from the down slope toe of the mound to the respective features. As with all wastewater infiltration systems on sloping sites that have primarily horizontal flow from the mound, a greater down slope horizontal

separation distance may be appropriate to avoid weeping into a ditch or basement that may be located down slope.

9. *Sites with Trees and Large Boulders* – Generally, sites with large trees, numerous smaller trees or large boulders are less desirable for mound systems because of the difficulty in preparing the site. If a more desirable site is not available, the trees must be cut at ground level. The stumps should not be removed. If the tree stumps and/or boulders occupy a significant amount of the surface area, the size of the mound should be increased to provide sufficient soil to accept the effluent. The site evaluator should provide location and size information about trees and boulders.
- B. *Mound Design Concepts* – As with all soil absorption systems, a mound wastewater infiltration system must be sized and configured to match the soil and site conditions and the volume and quality of wastewater applied to it. Thus, it is imperative that the designer has sufficient information about the quality and quantity of effluent, soil and site features and understands the mound operating principles. The Soil Classifier or site evaluator must accurately estimate the design soil loading rate (Table 6.F) and determine the direction of flow away from the system (Figure 24.F) before the mound can be properly designed.

The design consists of estimating the: 1) sand fill loading rate, 2) soil (basal) loading rate and 3) linear loading rate for the site. Once these three design rates are determined, the mound can be sized for the site. Figures 27.F and 28.F show a cross section and plan view of the mound on sloping and level sites, respectively, and show dimensions that must be determined.

1. *Sand Fill Loading Rate* – The design sand loading rate for the absorption area (aggregate/sand interface) in Figures 27.F and 28.F is dependent upon the quality of effluent applied and the type and quality of fill material placed beneath the aggregate. The loading rate in this Manual assumes a sand is used that meets the guidelines and a typical domestic septic tank effluent quality. If commercial septic tank effluent is used, such as from restaurants, the loading rates should be reduced as the strength of the effluent may be much greater thus accelerating and intensifying the clogging of the aggregate/sand interface (Seigrest et al., 1985). If higher quality effluent is used, such as that from sand filters or aeration units, higher design loading rates may be justified. Limited experience with different qualities of effluent wastewater makes it difficult to predict long term loading rates.

The purpose of the sand fill, along with the native soil, is to treat the effluent to an acceptable level. A very coarse sand will not provide adequate treatment and a very fine sand cannot be loaded at acceptable levels without severe clogging, thus resulting in mound failure. Thus, a sand must be selected that provides satisfactory treatment and allows for a reasonable loading rate.

During the initial development of the mound, medium sand (USDA classification) was considered suitable for mound fill but it was soon shown that premature failure resulted for sand fill that was on the fine side of medium or was a fine sand. Bank run sand, which was classified as medium sand, was also found unsuitable, in most cases, as it was usually poorly sorted and contained a lot of fines. Currently the recommendation is to use a coarse sand with a minimum amount of fines, which appears to give acceptable treatment at an acceptable loading rate. It is also important to provide a specification that provides acceptable treatment and is available at a reasonable cost.

Standard classifications such as USDA are not suitable as they are very broad. For example, a coarse sand may or may not be acceptable while a medium sand may be, as it depends upon a combination of various sand fractions.

Figure 26.F can be used as a guide for selecting a suitable mound sand fill. Based on a sieve analysis of the total sample, the sand fill specification should fit between the ranges given in Figure 26.F. In addition, the sand fill must not have more than 20% (by wt) material that is greater than 2 mm in diameter, which can include stone, cobbles and gravel. Also, there must not be more than 5% silt and clay (<.053 mm) in the fill. This guideline is based on experience and judgment. According to USDA classification, this is a coarse sand; however, many other sands could be defined as coarse sand according USDA and not meet this guideline for mound sand fill. C-33 specification (ASTM, 1984) for fine aggregate does fit within this guideline but the coarser (>2 mm) and finer (<.053) fractions must be evaluated to make sure they meet the limits. A sand with an effective diameter (D10) of 0.15 to 0.3 and a uniformity coefficient (D60 /D10) between 4 and 6 fit within this guideline provided the coarser (>2 mm) and finer (<.053) fractions meet the guideline.

The recommended design loading rate for a sand fill that meets this guideline (Figure 26.F) is 1.0 gpd/ft<sup>2</sup> if the effluent is a typical domestic septic tank effluent. This assumes that there is a factor of safety provided. It assumes, for design purposes, that a home generates 75 gpcd with two people per bedroom or 150 gallons per bedroom per day. Based on a number of studies, the average quantity of effluent generated per day is about 45 gpcd (Witt et al. 1974). Converse and Tyler, 1987, found, based on water meter reading in the home, that the wastewater generated in the home averaged 47% of design with a range of 29 to 82%. If water meter readings are used for design purposes, the design sand loading rate should be reduced accordingly. Systems loaded to design without appropriate factor of safety will fail due to overloading. Similar procedures should be followed for commercial establishments including lower loading rates due to the higher strength effluent as discussed above.

2. *Basal Loading Rates* – The basal area (sand/soil interface in Figures 27.F and 28.F) is the area enclosed by the B (A+I) for sloping sites (Figure 27.F) and B (A+I+J) for level sites where J equals I for level sites (Figure 28.F). It is sized according to the long-term infiltration rate (assuming a clogging mat forms) for the soil at the sand/soil interface (Table 6.F). This interface receives relatively clean effluent since the wastewater has already passed through sand and normally a clogging mat does not develop at this interface, thus over sizing the basal area. Additional over sizing usually results because the distance required to maintain a 3:1 mound side slope is greater than that required for the infiltration basal width except for maybe the very slowly permeable soils or the very steep sites.
3. *Linear Loading Rate* – The linear loading rate is defined as the amount of effluent (gallons) applied per day per linear foot of the system (gpd/lf). The design linear loading rate is a function of effluent movement rate away from the system and the direction of movement away from the system (horizontal, vertical or combination, Figure 24.F). If the movement is primarily vertical, then the linear loading rate is not as critical as if the flow is primarily horizontal. Other factors such as gas transfer from beneath the absorption area suggests that the absorption area width be relatively small

(Tyler et al, 1986). It is difficult to estimate the linear loading rate for a variety of soil and flow conditions, but based on the authors' experience, "good estimates" can be given. If the flow away from the system is primarily vertical, then the linear loading rate can be high, but should be in the range of 8 to 10 gpd/lf otherwise; the absorption area is excessively wide, especially for the slower permeable soils such as silt loams. However, if the flow is shallow and primarily horizontal then the linear loading rate should be in the range of 3 to 4 gpd/lf. This approach will result in long and narrow systems.

4. *Dimensioning the Mound* – Figures 27.F and 28.F show the cross section and plan view of the mound for sloping and level sites. The dimensions are based on the site conditions and loading rates that are site-specific.
  - a. Absorption Area Width (A) – The width of the absorption area is a function of linear loading rate and the design loading rate of the sand fill selected.
  - b. Absorption Area Length (B) – The length of the absorption area is a function of the design loading rate (gpd) and the width of the absorption area (A).
  - c. Basal Length and Width – For sloping and level sites the basal width is (I + A) and (I + J + A), respectively, and the basal length is (B). The width is determined by the linear loading rate and the infiltration rate for the surface soil horizon (sand/soil interface).
  - d. Slope Width (I) and (J) – For sloping sites the down slope width (I) is a function of the basal width (A + I) and the absorption area width (A). Upslope width (J) is a function of the 3:1 recommended side slope and is dependent upon the depth of the mound and the slope of the site. A typical dimension is 8 to 10 ft. but can be greater or less depending on the desired mound side slope and the slope of the site. For level sites the slope widths (J) and (I) are equal and are a function of the required basal width or the minimum recommended mound side slopes, whichever is greater.
  - e. Slope Length (K) – The slope length (K) is a function of the mound depth and the desired mound end slope. The recommended end slope is 3:1 but can be greater. Steeper mound side slopes are not recommended as they can become a safety hazard if the mound is to be mowed. Typical dimensions are 10 - 15 ft.
  - f. Depth (D) – This depth is a function of the suitable soil separation depth required by code and the depth of the limiting condition from the soil surface. If the required separation distance from the absorption surface to the limiting condition, such as bedrock or high water table, is 3 ft and the limiting condition is 1 ft beneath the ground surface, then (D) must be a minimum of 2 ft.
  - g. Depth (E) – This depth is a function of the surface slope and width of the absorption area (A) as the absorption area must be level.
  - h. Depth (F) – This depth is at least 9 in. with a minimum of 6 in. of aggregate beneath the distribution pipes, approximately 2 in. for the distribution pipe and 1 in. of aggregate over the pipe.
  - i. Depth (G) and (H) – The recommended depth for (G) and (H) is 12 in. and 18 in., respectively, for the colder climates and 6 in. and 12 in. for the warmer climates. The (H) depth must be greater than the (G) depth to promote runoff on the top of the mound.

5. *Mound Cover* – The purpose of the soil cover is to provide a medium for a vegetative cover and protection. Any soil material that will support a suitable vegetative cover is satisfactory. This material may range from a sandy loam to a clay loam. A sand does not support a suitable vegetative cover. A heavier textured soil will promote more precipitation runoff than a lighter texture soil and will also hold more moisture during dry periods thus reducing the drying out of the vegetative cover on the top and sides.
  6. *Effluent Distribution Network* – The mound system is designed with a pressure distribution network to distribute the effluent along the length of the mound. Gravity distribution will not distribute it uniformly but drops it in one or two locations (Converse, 1974), Machmeier and Anderson, 1988). Otis, 1981, gives design criteria and examples for pressure distribution.
  7. *Observation Tubes* – It is essential for all soil absorption systems to have observation wells extending from the infiltrative surface (aggregate/sand interface) to or above the ground surface for the purposes of observing the performance of the infiltrative surface. The tubes provide an easy access to the infiltrative surface to see if ponding is occurring. Tubes should be placed at 1/6, 1/2 and 5/6 points along the length of the absorption area. All observation tubes must be securely anchored. Figure 25.F illustrates three methods of anchoring the observation tubes. Slip or screw caps can be used. If brought to the surface, they should be recessed slightly as lawn mowers may destroy the caps. If brought above ground surface, schedule 40 PVC pipe is required.
- C. *Mound Performance* – The first Wisconsin mound system of the current design was installed in 1973. In Wisconsin alone there are over 12,000 mound systems. Many other states have adopted the technology. Proper siting of all soil absorption systems, including the mound, is essential otherwise the system may not function as planned.
- In Wisconsin the mound system has a success rate of over 95% (Converse and Tyler, 1986). This success rate is due in part to a very strong educational program relating to siting, design and construction.
- A mound can fail either at the 1) aggregate/sand interface due to a clogging mat or 2) at the sand/soil interface due to the inability of the soil to accept the effluent. Converse and Tyler (1989) discuss the mechanisms that may cause failure and methods to rectify the problems.
- D. *Mound Construction* – A construction plan for any on-site system is essential. A clear understanding between the site classifier, designer, contractor and inspector is critical if a successful system is installed. It is important that the contractor and inspector understand the principles of operation of the mound system before construction commences otherwise the system may not function as intended. It is also important to anticipate and plan for the weather. It is best to be able to complete the mound before it rains on it. The tilled area and the absorption area must be protected from rain by placing sand on the tilled area and aggregate on the absorption area prior to rain. The following points are essential:
1. The mound must be placed on the contour. Measure the average ground elevation (prior to tillage) along the upslope edge of the absorption area, which will be used to determine the elevation of the absorption area.

2. Grass, shrubs and trees must be cut close to the ground surface and removed from the site. In wooded areas with excessive litter, it is required to rake the majority of it from the site.
3. Locate the entrance of the force main into the mound. It is required to bring it into the center on the upslope side. If it must be brought in from the down slope side, especially on sites with horizontal flow, it must be brought in perpendicular to the side of the mound with minimal disturbance to the down slope area.
4. The mound site must be tilled when at the proper moisture level. The proper moisture level to a depth of 7 to 8 in. must be such that the soil will crumble and not take on a wire form when rolled between the palms. The purpose is to roughen up the surface and incorporate most of the vegetation. This can be done with a mold board plow, chisel plow or chisel teeth mounted on a tool bar attached to the bucket of a backhoe. The backhoe bucket teeth are not satisfactory and must not be used. Rototillers are prohibited on structured soils but can be used on unstructured soils such as sands. However, they are not recommended. Tilling along the contour is required. Protect the tilled area from rain by placing a layer of sand on it.
5. If a platy structure is present in the upper horizons, it is necessary to till it. Normally, the chisel teeth mounted on a backhoe bucket is preferred as it can be used to till around stumps and till deeper than the other methods. Stumps are not to be removed but tilled around. If there is an excessive number of stumps or boulders, then the basal area should be enlarged or another site found.
6. Once the site is tilled, a layer of sand should be placed before it rains on the tilled area. Placement of the sand should be such as not to rut up or compact the tilled area. All work shall be done from the upslope side so as not to compact the down slope area especially if the effluent flow is horizontal away from the system. Sand should be placed with a backhoe or moved around the site with a track type tractor. Wheeled tractors will rut up the site.
7. Place the proper depth of sand then form the absorption area with the area bottom being level. Protect this infiltrative area from rain by placing the aggregate prior to rain.
8. Place a suitable aggregate to the desired depth in the area provided. The aggregate must be clean and sound and not deteriorate. Limestone is not recommended.
9. Place the pressure distribution pipe and connect it to the force main and cover with 1 in. of aggregate.
10. Cover the aggregate with a geotextile synthetic fabric.
11. Place a minimum of 6 inches of suitable soil cover on the sides of the mound and to the prescribed depth on the top of the mound.
12. Final grade the mound and area with light weight equipment so surface water moves away from the mound and does not accumulate on the upslope side of the mound.
13. Seed and mulch the entire exposed area to avoid erosion. Landscape it with shrubs and plants so that it fits into the surrounding area. The top of the mound may be somewhat dry during the summer months and the down slope toe may be somewhat moist during the wet seasons (Schutt, 1981).

## 6) Minimum Criteria for Pressurized Subsurface Absorption Fields Utilizing Emitters

Subsurface systems utilizing emitters may be used in lieu of conventional or other alternative absorption fields. The number of subsurface land disposal systems continues to increase as sites are developed with conditions unsuitable for many other wastewater treatment systems. This document provides guidelines and criteria for the planning, design and operation of pressurized subsurface absorption fields utilizing emitters, commonly referred to as drip irrigation.

The term drip irrigation as used in this document refers to the treatment of wastewater by irrigation below the land's surface. These systems are designed and operated so that there is no direct discharge of wastewater to the land's surface. The irrigated wastewater transpires to the atmosphere and enters the groundwater through infiltration and percolation. Organic constituents in the wastewater are consumed or stabilized by soil bacteria. Organic and ammonia nitrogen are taken up by plants, nitrified by soil bacteria, lost to the atmosphere through denitrification, leached into the groundwater or stored as soil nitrogen in the site biota. Phosphorous and many metal constituents are absorbed into soil particles and taken up by plants. Properly designed and operated wastewater irrigation systems produce a percolate water of high quality and thus protect ground and surface waters.

The criteria in this document only apply to domestic wastewater. The drip irrigation technology is based on maintaining aerobic conditions in the soil. Therefore, dosing and resting cycles must be established as part of the plan of operation and management. In order for systems to maximize nitrogen removal and prevent nitrate nitrogen from contaminating the groundwater, the installation of the subsurface dripper lines should be within the root zone of the cover vegetation. The on-site wastewater system will consist of aerobic pretreatment followed by a subsurface distribution system utilizing emitters to distribute a controlled flow of wastewater to the soil. Drip irrigation systems must be capable of providing an equal flow distribution of wastewater effluent applied throughout the application field (s) at a predetermined application rate. It is imperative that all drip irrigation systems maintain uniform and accurate control of the effluent emission rates. Equipment must be provided that will identify and record any fluctuations in the wastewater flow through the system. All equipment proposed for use must be certified and warranted by the manufacturer that it has been tested for use with wastewater. A drip irrigation system may be sold as a complete package. All prepackaged systems must be approved by the Department prior to sale in the state of Georgia. A state of Georgia Registered Engineer must design drip irrigation systems designed on a site-specific basis.

### A. Design Criteria:

1. *Aerobic Pretreatment* – The drip emitter system shall be preceded by a pretreatment process designed to reduce the wastewater biological oxygen demand (BOD5) to a maximum concentration of 25 milligrams per liter (mg/l) and total suspended solids (TSS) concentration to a maximum of 30 milligrams per liter (mg/l). The aerobic pretreatment process must be reviewed by Technical Review Committee and approved by the Department.
2. *Dosing Tanks*:
  - a. The dosing chamber shall meet all requirements established in the On-Site Manual and have a minimum capacity equal to the 24-hour waste flow from the facility

- served. The dosing chamber shall be equipped with an audible and visible alarm that indicates a high water level or loss of power to the pump or controls.
- b. Time dosing shall be utilized to dose the absorption field or zones. The frequency of dosing shall be based on the soil's hydraulic loading rate and the design flow. Fields or zones shall be time dosed to insure the total 24-hour wastewater effluent flow is applied in a 24-hour period.
  - c. All new systems must be equipped to detect a plus (+) or minus (-) 10% change in flow rate in the disposal field due to clogging of the filters, a force main break, emitter clogging, leaks in the field lines and a flush valve failure.
3. *Subsurface Absorption Field* – All components of the subsurface absorption system must be reviewed by Technical Review Committee and approved by the Department for use in the state of Georgia. Any component changes will require a review and approval prior to use. The emitter subsurface absorption field system must meet the following requirements:
- a. Dose the entire absorption field or zone equally. The length of each distribution line shall not exceed the manufacturers' specifications to insure equal application of wastewater effluent from each emitter. No more than a 10 percent variation in flow between individual emitters anywhere within a separately dosed zone, including drain back is acceptable.
  - b. Drain back - When slopes exceed five percent, check valves or other approved means shall be used in the supply and return manifolds to minimize drainage into the lowest area of the zone.
  - c. Emitter line and emitters must be warranted by the manufacturer for wastewater application and approved by the Department. Emitter lines must be identified with the manufacturer's name and product number. Emitters shall be pressure or non-pressure compensating emitters. Emitters shall be spaced either one foot or two feet apart within the emitter line.
  - d. The wastewater effluent must be filtered to emitter manufacturer's specifications to insure the proper operation of the distribution system.
  - e. The filtration system shall be automatically self-cleaning and the filter residue and backwash returned to the treatment unit, with provisions made to minimize disturbance of any solids settling in the chamber (ex. Provide baffles or comparable intake structure in septic tank to minimize solids re-suspension in the inlet compartment).
  - f. Typically, separation between emitter line laterals will be two feet. However, a one-foot separation between emitter line laterals may be allowed without a reduction in absorption field area. Lateral spacing of three feet or greater is required on slopes exceeding 20%.
  - g. Individual emitter lines shall be designed and installed level, following the naturally occurring ground contour, with a maximum allowable variance of plus (+) or minus (-) six (6") inches within any linear one hundred (100') foot segment.

- h. Emitter lines shall be installed in the root zone of the cover vegetation, a depth of 8 to 12 inches from the original undisturbed ground surface, and /or shall be a minimum of eight inches from the ground surface.
  - i. A system for automatic flushing of distribution lines should be provided and performed according to manufacturer's recommendations, at a minimum on a bi-monthly basis. Velocities must be a minimum of two feet per second at the distal end of each drip irrigation line or return line during the flushing operation.
  - j. All materials shall meet applicable ASTM standards, be chemical resistant, and be approved for wastewater usage.
  - k. Equipment susceptible to freezing must be adequately protected to prevent freezing.
  - l. There must be a totally separate absorption field replacement area equivalent in size to 100% of the emitter field installed or for a conventional absorption field, whichever is larger.
  - m. A vibratory plough, ditch witch or backhoe may be utilized for drip line installation.
4. *Site Criteria:*
- a. The minimum horizontal setback requirements established in the On-Site Sewage Management System Manual, Chapter 511-3-1-.07 (3) shall be met.
  - b. Required vertical separation requirements shall be measured from the bottom of the drip tubing or trench bottom, whichever is greater.
  - c. There shall be a minimum vertical separation of 12 inches between the bottom of the absorption field and any seasonal groundwater table, rock or impervious soil strata. Greater vertical separation may be required if a site is hydraulically limited as determined by soil investigations by the Soil Classifier or design engineer.
  - d. Areas subject to surface water ponding shall not be considered for installation.
5. *Absorption Field Sizing:*
- a. Table 7.F shall be used in determining the hydraulic loading rate for subsurface absorption fields utilizing emitters. The design hydraulic loading rate shall be based on the most hydraulically limiting, naturally occurring soil horizon within one (1') foot of the drip line or trench bottom, whichever is greater.
  - b. Facilities utilizing approved aerobic pretreatment shall not have a waste stream that exceeds a fat, oil and grease content of 25mg/l prior to soil application.
  - c. In calculating the number of square feet for the absorption field, the design daily sewage flow shall be divided by the maximum hydraulic loading rate determined by the Table 7.F. In calculating the minimum linear length of drip emitter line required, the total square footage of the absorption field shall be divided by two feet.
  - d. There shall be a totally separate area available for 100% replacement of the emitter absorption field or a conventional absorption field, whichever is larger.
6. *Application Requirements* – The following information shall be submitted to the local county health department for evaluation and approval in order to obtain a construction

- permit for an on-site sewage management system utilizing pressurized subsurface absorption fields with emitters:
- a. A Level 4 soil investigation including detail with soil horizons identified and hydraulic loading rates determined for each horizon.
  - b. A site plan at a minimum scale of 1 inch to 40 feet including; topography with two feet contour changes and soil types overlaid; house or facility location scaled with driveways, sidewalks, parking, and other structures shown; location of utilities, wells, water bodies or courses and easements.
  - c. Sewage system must be scaled on site plan including; pretreatment unit, drip line (wastewater approved), force main, return line, manifolds, location of check valves and air vents.
  - d. System Design Criteria including; type of pretreatment, sewage flow rate, absorption line calculation, pump size (make and model #), and pipe sizes identified (schedule 40).
  - e. Type of emitter tubing (manufacturer and product # - wastewater approved).
  - f. A manufacturer certified system design approved by the Department or a state of Georgia Registered Engineer system design is required. A state of Georgia Registered Engineer shall design systems with a design sewage flow in excess of 2,000 gallons per day.
  - g. Site plans shall bear the signature of the designer and the following statement: I certify this sewage system design meets the minimum design requirements established by the Georgia Department of Public Health's Manual for On-Site Sewage Management Systems.
7. *Operation and Maintenance* - Satisfactory operation and maintenance of pressurized subsurface absorption fields are necessary to safeguard the health of the user and the public.
- a. A three-year initial service policy shall be furnished to the user by the manufacturer or licensed distributor and shall be included in the original purchase price. This policy shall provide:
    - (1) A minimum of 6 inspection/service visits (scheduled once every six months over the three-year period), during which electrical, mechanical, and other applicable components are inspected, adjusted, serviced and/or replaced.
    - (2) Emergency service shall be available within no more than two days following a request. The owner and local county health authority shall be notified immediately in writing of any improper operation observed which cannot be corrected at the time of the service call and the estimated date of correction.
    - (3) A clearly visible, permanently attached label or plate, giving instructions for obtaining service, shall be placed at the visual alarm signal.
  - b. An owner's manual shall be provided by the manufacturer or licensed distributor to the facility owner.
  - c. Facility owners shall be offered a continuing service contract.

- d. Facilities with a design flow in excess of 2,000 gallons per day shall submit to the local health authority a Plan of Operation and Management. The plan must address wastewater application rates, drip field cycling, monitoring requirements, maintenance schedules and all other information necessary for successful operation.

**7) Guidelines for domestic wastewater application for absorption fields designed for Class I effluent**

- A. Systems producing a Class I effluent quality are allowed a vertical separation distance of 12 inches between the bottom of the absorption trench and any restrictive horizon with no reduction in absorption field size.
- B. Systems producing a Class I effluent quality are allowed an absorption field reduction provided the restrictive horizon is a minimum of 24 inches below the bottom of the absorption trench.
- C. Maximum absorption field reduction shall be based on the standards established through the Technical Review committee as illustrated in Table 8.F.
- D. When a Class I effluent system is used in conjunction with an absorption field bed design, timed dosing of the effluent shall be utilized to dose the absorption field. The frequency of dosing shall be based on the soil's hydraulic conductivity and the design flow. The absorption field bed shall be time dosed in a manner that uniformly distributes the effluent across the entire bed with no more than a 10% variation in flow. The absorption field shall be time dosed to ensure the expected 24-hour effluent flow is applied in a 24-hour period.
- E. The required absorption field area shall be based on the most hydraulically limiting soil horizon in contact with the infiltrative surface of the absorption field sidewall, bottom and extending for a distance one (1') foot below the absorption field.

## 8) Tables, Figures, and Forms

**Table 5.F Recommended Soil and Site Criteria for Wisconsin Mound System**

<b>Parameter</b>	<b>Value</b>
Depth to Seasonal High water Table	10 inches
Depth to Crevice Bedrock	2 feet
Depth to Non-Crevice Bedrock	1 foot
Permeability of Top 10 inches	Moderately Low
Site Slope	25%
Filled Site	Yes*
Over Old System	Yes**
Flood Plains	No
<p><i>*Suitable according to soil criteria (texture, structure, consistence)</i></p> <p><i>**The area and backfill must be treated as fill as it is a disturbed site.</i></p> <p><i>Note: Table based on research and field experience (Converse and Tyler, 1985,1987)</i></p>	

**Table 6.F Estimated Design Basal Loading Rates**

Basal Loading Rates for Surface Horizon Based on Soil Morphological Conditions for Wisconsin Mound Systems ( <i>Instructions: Read questions in sequence. When the conditions of your soil match the question, use that loading rate and do not go further</i> )		
Soil Condition of Horizon at Sand/Soil Interface		If yes, Loading Rate in gpd/ft <sup>2</sup>
1.	Is the horizon gravelly coarse sand or coarser?	0.0
2.	Is consistence stronger than firm or hard, or any cemented class?	0.0
3.	Is texture sandy clay, clay, or silty clay of high clay content and structure massive or weak, silt loam and structure massive?	0.0
4.	Is texture sandy clay loam, clay loam, or silty clay loam and structure massive?	0.0
5.	Is texture sandy clay, clay, or silty clay of low clay content and structure moderate or strong?	0.2
6.	Is texture sandy clay loam, clay loam, or silty clay loam and structure weak?	0.2
7.	Is texture sandy clay loam, clay loam, or silty clay loam and structure moderate or strong?	0.4
8.	Is texture sandy loam, loam or silt loam and structure weak?	0.4
9.	Is texture sandy loam, loam or silt loam and structure moderate or strong?	0.6
10.	Is texture fine sand, very fine sand, loamy fine sand, or loamy very fine sand?	0.6
11.	Is texture coarse sand with single grain structure?	0.8

**Table 7.F Hydraulic Loading Rates for Fields Utilizing Emitters, Class I Effluent**

Soil Group	Soil Textural Classes (USDA classification)	Percolation Rate (minutes/inch)	Maximum Hydraulic Loading Rate (gpd/ft <sup>2</sup> )
I	Sands (Sand and Loamy Sand)	<10	0.4 – 0.3
II	Coarse Loams (Sandy Loam and Loam)	10-30	0.3 – 0.15
III	Fine Loams (Sandy Clay Loam, Silt Loam, Clay Loam, Silty Clay Loam, Silt)	30-60	0.15 – 0.1
IV	Clays (Sandy Clay, Silty Clay, Clay)	>60	0.1 – 0.04

**Table 8.F Absorption Field Sizing Coefficients for Class I Effluent Systems**

This chart correlates (approx.) percolation rates, soil texture and infiltration rates for the purpose of absorption field sizing for approved systems in Georgia producing a Class I effluent for domestic wastewater application.

Percolation Rate Minutes/Inch	Soil Texture Classes (USDA classification)	Infiltration Rate Bed Absorption Field gallons/day/ft <sup>2</sup>		Infiltration Rate Trench Absorption Field gallons/day/ft <sup>2</sup>	
		Depth to Limiting Horizon			
		2 ft.	1 ft.	2 ft.	1 ft.
5	Group I – Sand: (Sand and Loamy Sand)	1.31	0.97	1.6	1.2
10		1.18	0.71	1.5	0.91
15		1.09	0.61	1.4	0.79
20		1.0	0.59	1.3	0.71
25		0.92	0.54	1.2	0.65
30	Group II – Coarse Loams: (Sandy Loam and Loam)	0.82	0.50	1.1	0.6
35		0.75	0.47	1.0	0.57
40		0.67	0.45	0.9	0.54
45		0.63	0.42	0.85	0.5
50		0.59	0.37	0.8	0.48
55		0.55	0.35	0.75	0.46
60	Group III – Fine Loams: (Sandy Clay Loam, Silt Loam, Clay Loam, Silty Clay Loam, Silt)	0.51	0.34	0.7	0.45
65		0.47	0.33	0.65	0.43
70		0.43	0.32	0.6	0.42
75		0.39	0.31	0.55	0.41
80		0.36	0.31	0.5	0.41
85		0.32	0.30	0.45	0.4
90		0.28	0.30	0.4	0.39
95		N/A	N/A	0.39	0.39
100	Group IV – Clays: (Sandy Clay, Silty Clay, Clay)	N/A	N/A	0.385	0.38
105		N/A	N/A	0.38	0.38
110		N/A	N/A	0.375	0.38
115		N/A	N/A	0.37	0.37
120		N/A	N/A	0.365	0.37

- 1) Systems producing a Class I effluent quality are allowed a vertical separation distance of 12 inches between the bottom of the absorption trench and any restrictive horizon with no reduction in absorption field size.
- 2) Systems producing a Class I effluent quality are allowed an absorption field reduction provided the restrictive horizon is a minimum of 24 inches below the bottom of the absorption trench.
- 3) Maximum absorption field reduction shall be based on the standards established through the Technical Review committee as illustrated in Table 8.F.

- 4) When a Class I effluent system is used in conjunction with an absorption field bed design, timed dosing of the effluent shall be utilized to dose the absorption field. The frequency of dosing shall be based on the soil's hydraulic conductivity and the design flow. The absorption field bed shall be time dosed in a manner that uniformly distributes the effluent across the entire bed with no more than a 10% variation in flow. The absorption field shall be time dosed to ensure the expected 24-hour effluent flow is applied in a 24-hour period.
- 5) The required absorption field area shall be based on the most hydraulically limiting soil horizon in contact with the infiltrative surface of the absorption field sidewall, bottom and extending for a distance one (1') foot below the absorption field.

**6) Table 9.F Percolation Coefficient Calculations for Non-Residential Facilities**

Percolation Rate minutes/inch (t)	Square root of time ( $\sqrt{t}$ )	ft <sup>2</sup> /gallon (multiply) ( $\sqrt{t}/5$ )	gallon/ft <sup>2</sup> (divide) ( $5/\sqrt{t}$ )	Percolation Rate minutes/inch (t)	Square root of time ( $\sqrt{t}$ )	ft <sup>2</sup> /gallon (multiply) ( $\sqrt{t}/5$ )	gallon/ft <sup>2</sup> (divide) ( $5/\sqrt{t}$ )
5	2.236	0.447	2.236	65	8.062	1.612	0.620
10	3.162	0.632	1.581	70	8.367	1.673	0.598
15	3.873	0.775	1.291	75	8.660	1.732	0.577
20	4.472	0.894	1.118	80	8.944	1.789	0.559
25	5.0	1.0	1.0	85	9.220	1.844	0.542
30	5.477	1.095	0.913	90	9.487	1.897	0.527
35	5.916	1.183	0.845	95	9.747	1.949	0.513
40	6.325	1.265	0.791	100	10.0	2.0	0.500
45	6.708	1.342	0.745	105	10.247	2.049	0.488
50	7.071	1.414	0.707	110	10.488	2.098	0.477
55	7.416	1.483	0.674	115	10.724	2.145	0.466
60	7.746	1.549	0.645	120	10.954	2.191	0.456

*Note: Effluent BOD and TSS levels must be lowered to 200 mg/l or below before application to drainfield. Public Health Services Formula  $C = 5/\sqrt{t}$*

**Table 10.F Residential Trench Absorption Field Sizing**

Percolation Rate (minutes/inch)	Absorption Area per Bedroom (ft <sup>2</sup> )	Percolation Rate (minutes/inch)	Absorption Area per Bedroom (ft <sup>2</sup> )
5	125	65	345
10	165	70	355
15	190	75	365
20	210	80	370
25	230	85	375
30	250	90*	380
35	265	95*	385
40	280	100*	390
45	300	105*	395
50	310	110*	400
55	325	115*	405
60	335	120**	410

*\*Note: For sites less than 3 acres in size, soil horizons that exceed a percolation rate of 90 minutes per inch shall not be considered for installation of a conventional on-site sewage management system.*

*\*\*Note: For sites of 3 acres or more in size, soil horizons that exceed a percolation rate of 120 minutes per inch shall not be considered for installation of a conventional on-site sewage management system.*

Figure 15.F Distribution Box System Installation Example

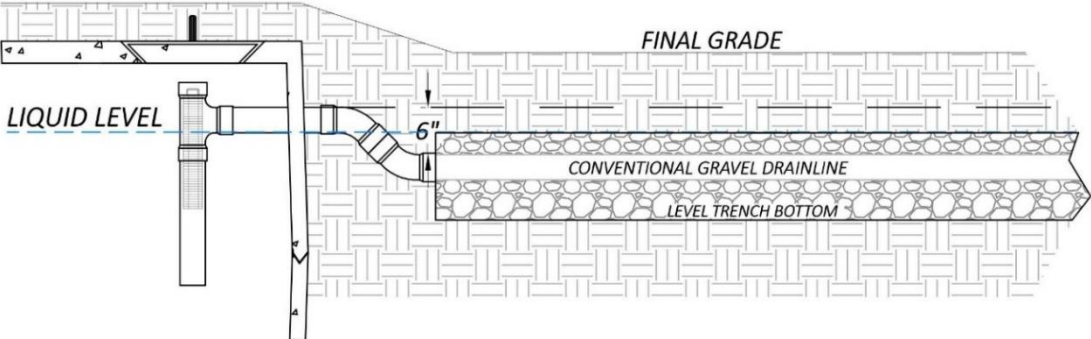

Figure 16.F Level Field Installation Example

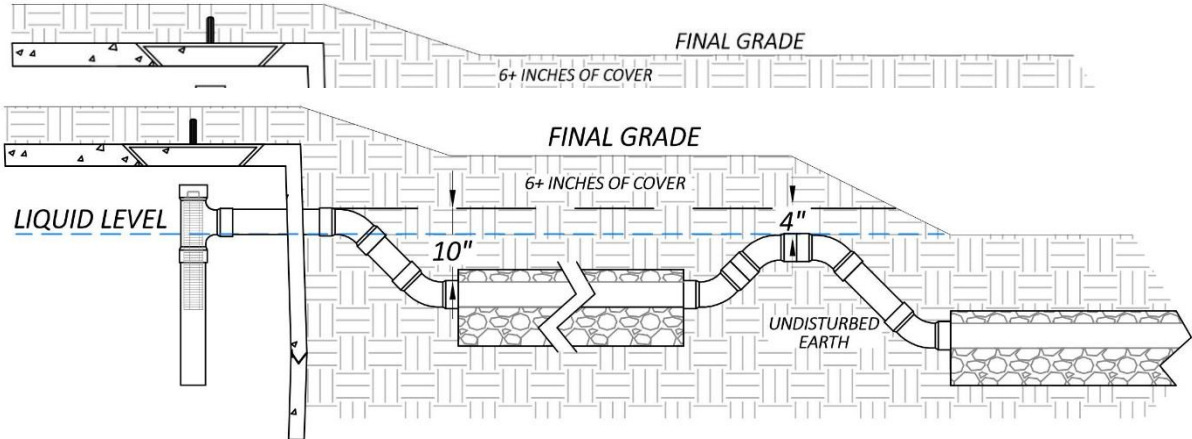
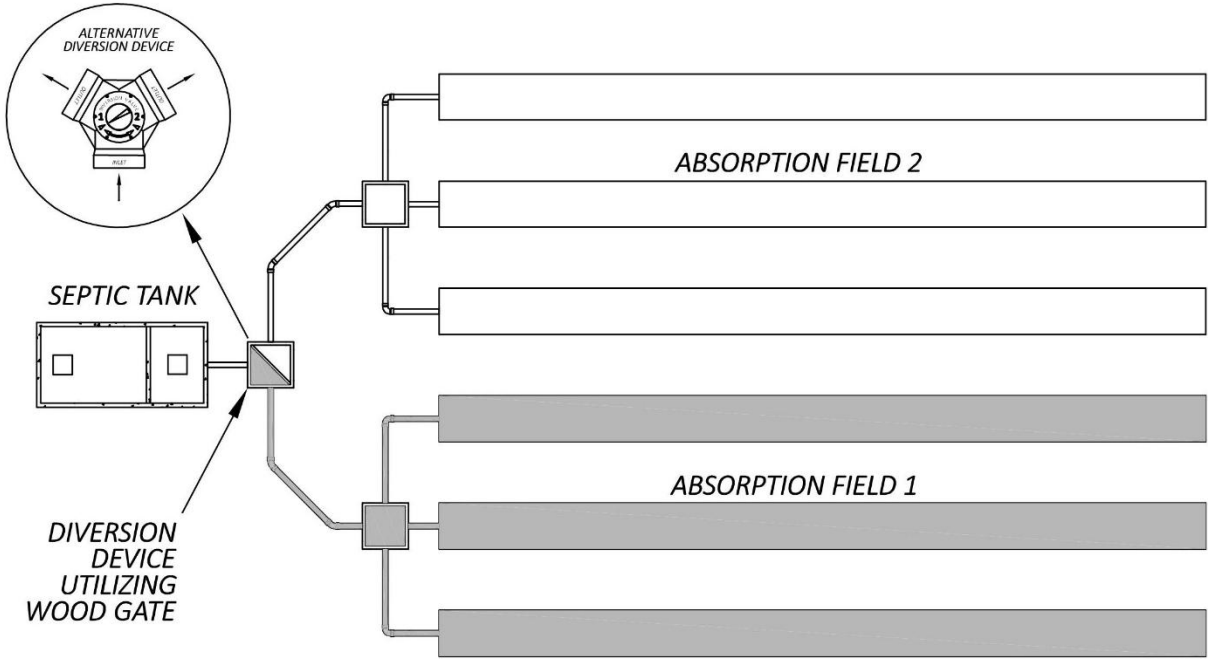
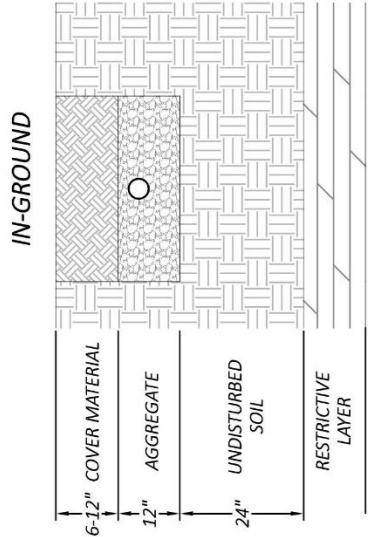
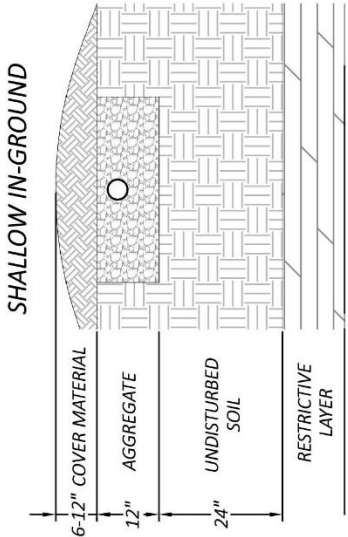

Figure 17.F Serial System Installation

Figure 18.F Alternating Drainfields with Diversion Valve



**Figure 19.F Trench Installation Examples**



**AT-GRADE AREA FILL MOUND**

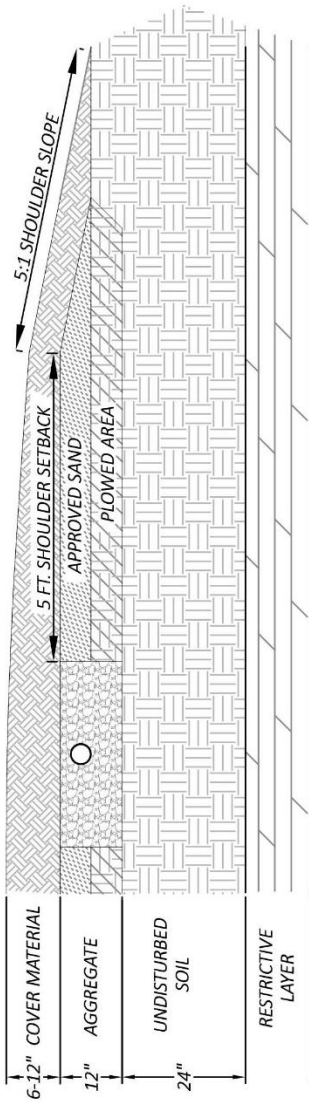

**ABOVE-GRADE AREA FILL MOUND**

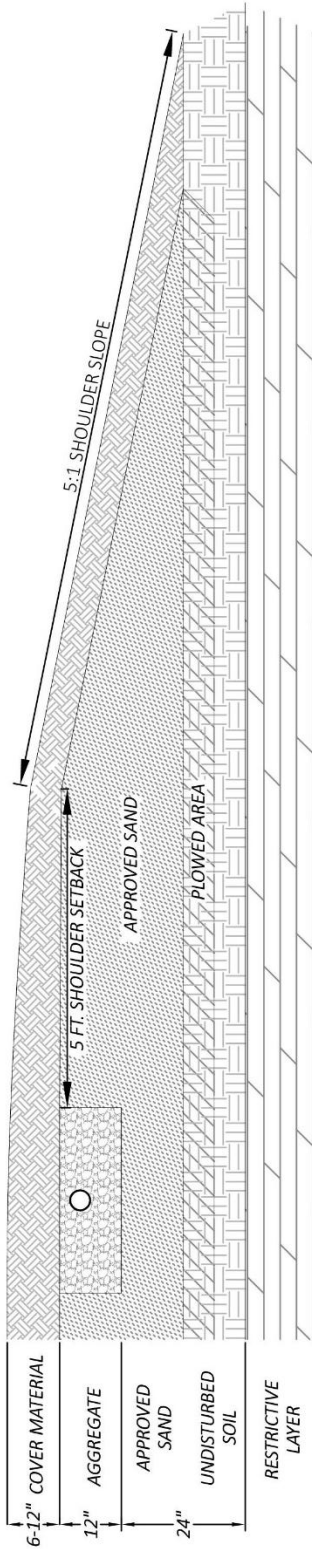

Figure 20.F Central Manifold Distribution Network

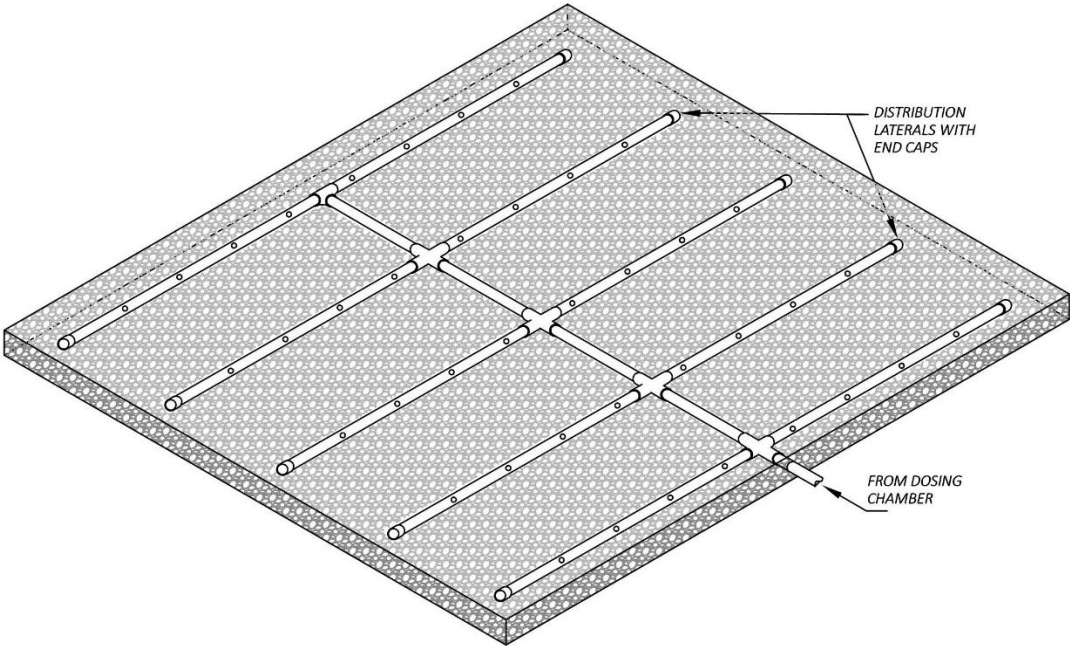

Figure 21.F End of Manifold Distribution Network

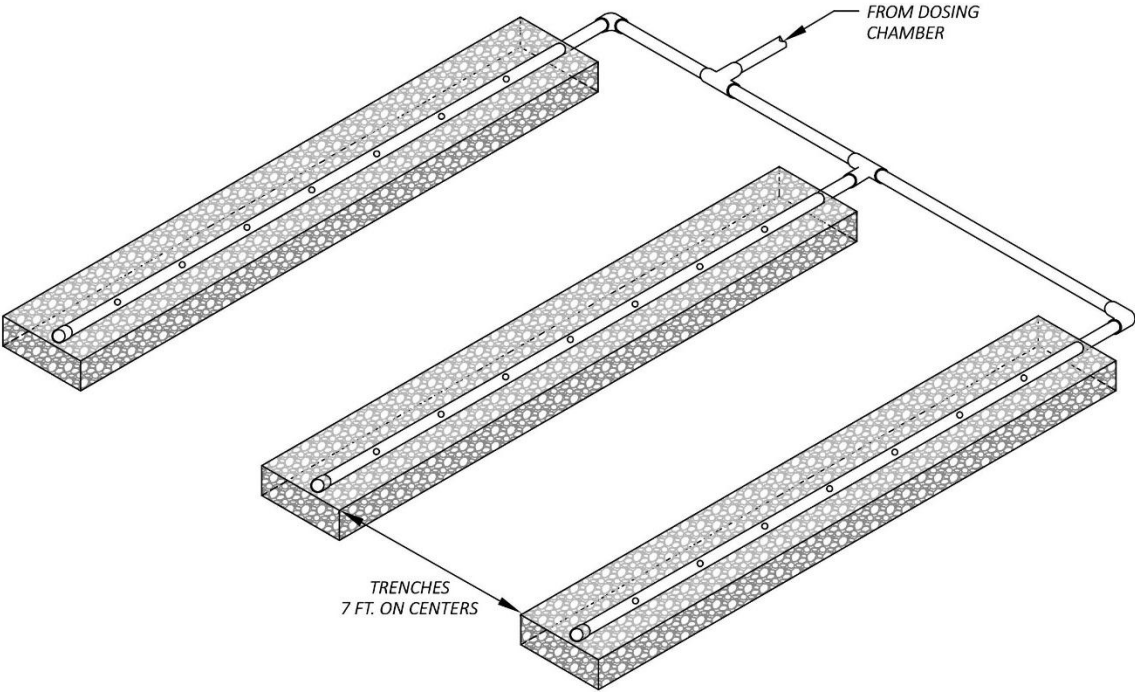

Figure 22.F Wisconsin Mound General Diagrams

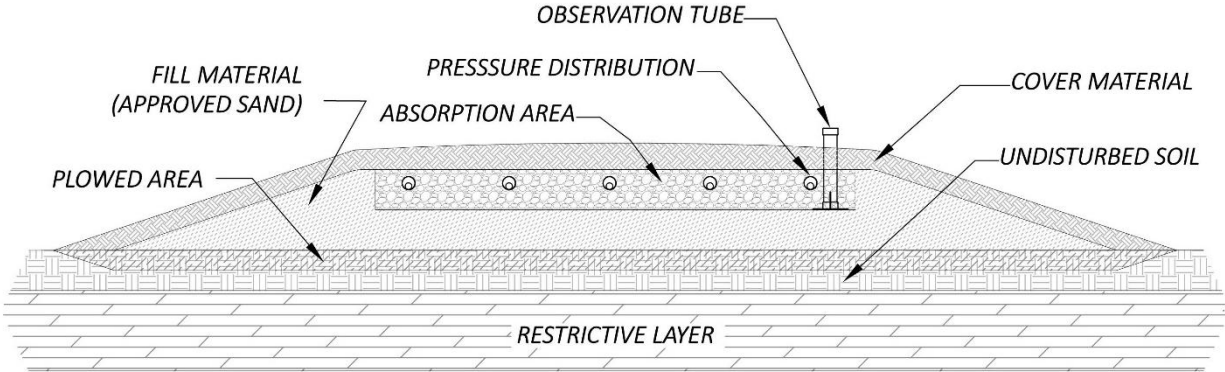

Figure 23.F Wisconsin Mound vs. Area Fill Mound Detail

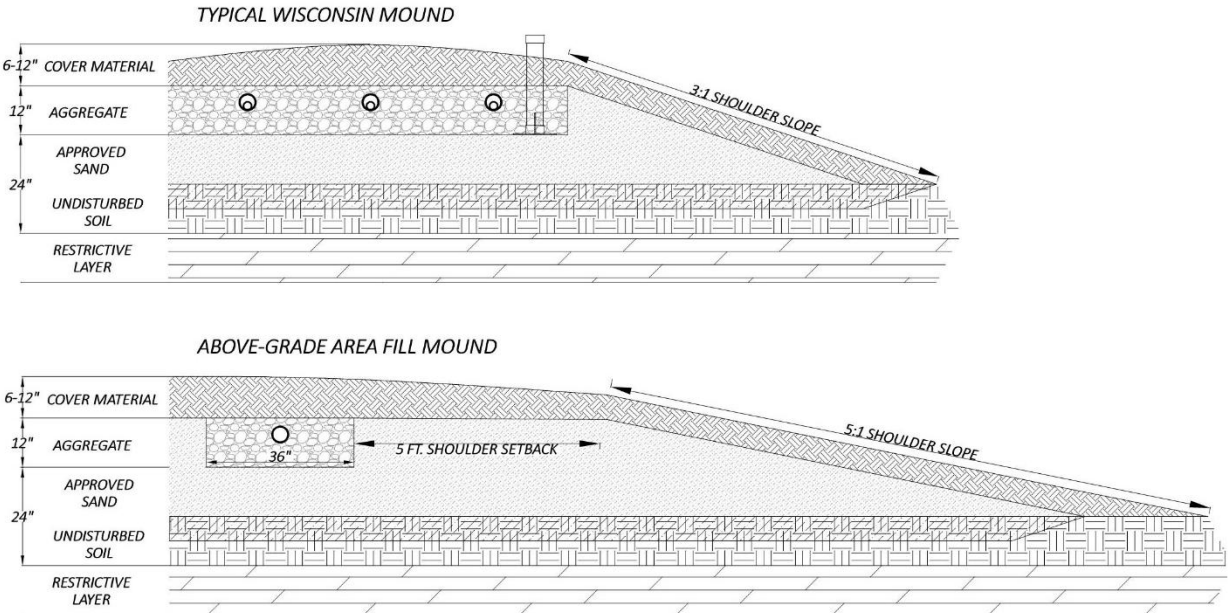

Figure 24.F Effluent Movement – Wisconsin Mound

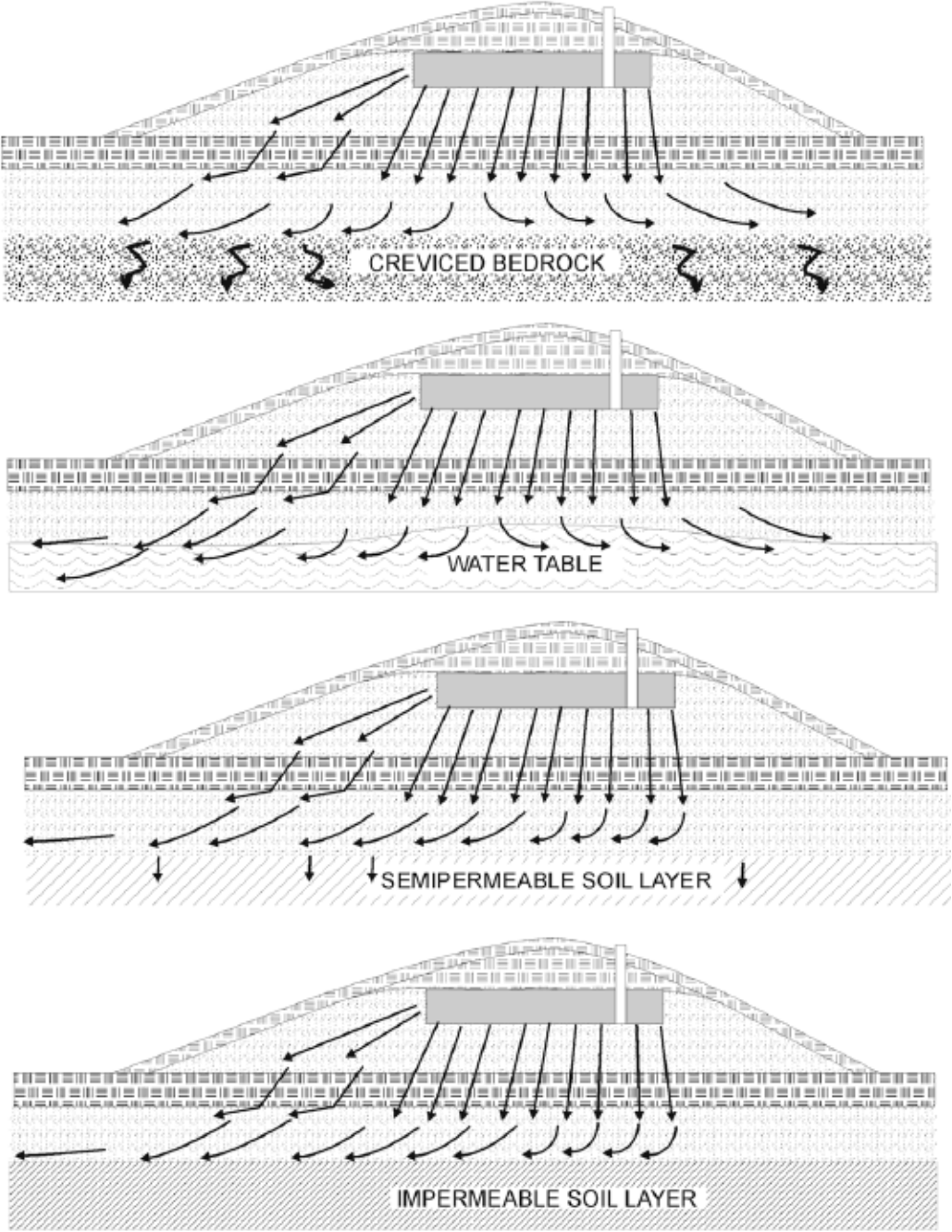

Figure 25.F Observation Tube Detail

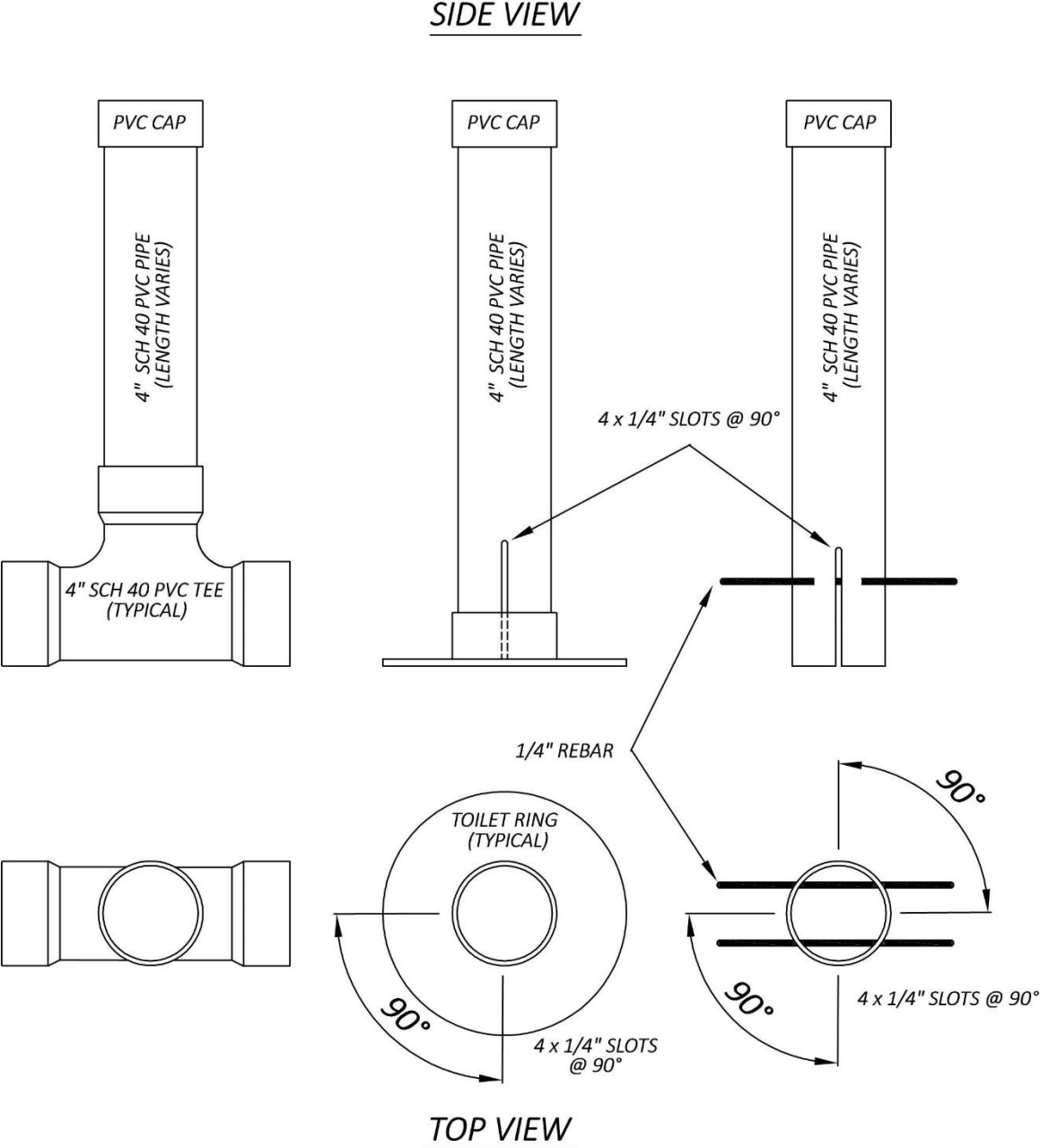

Figure 26.F Sieve Analysis for Acceptable Fill Material

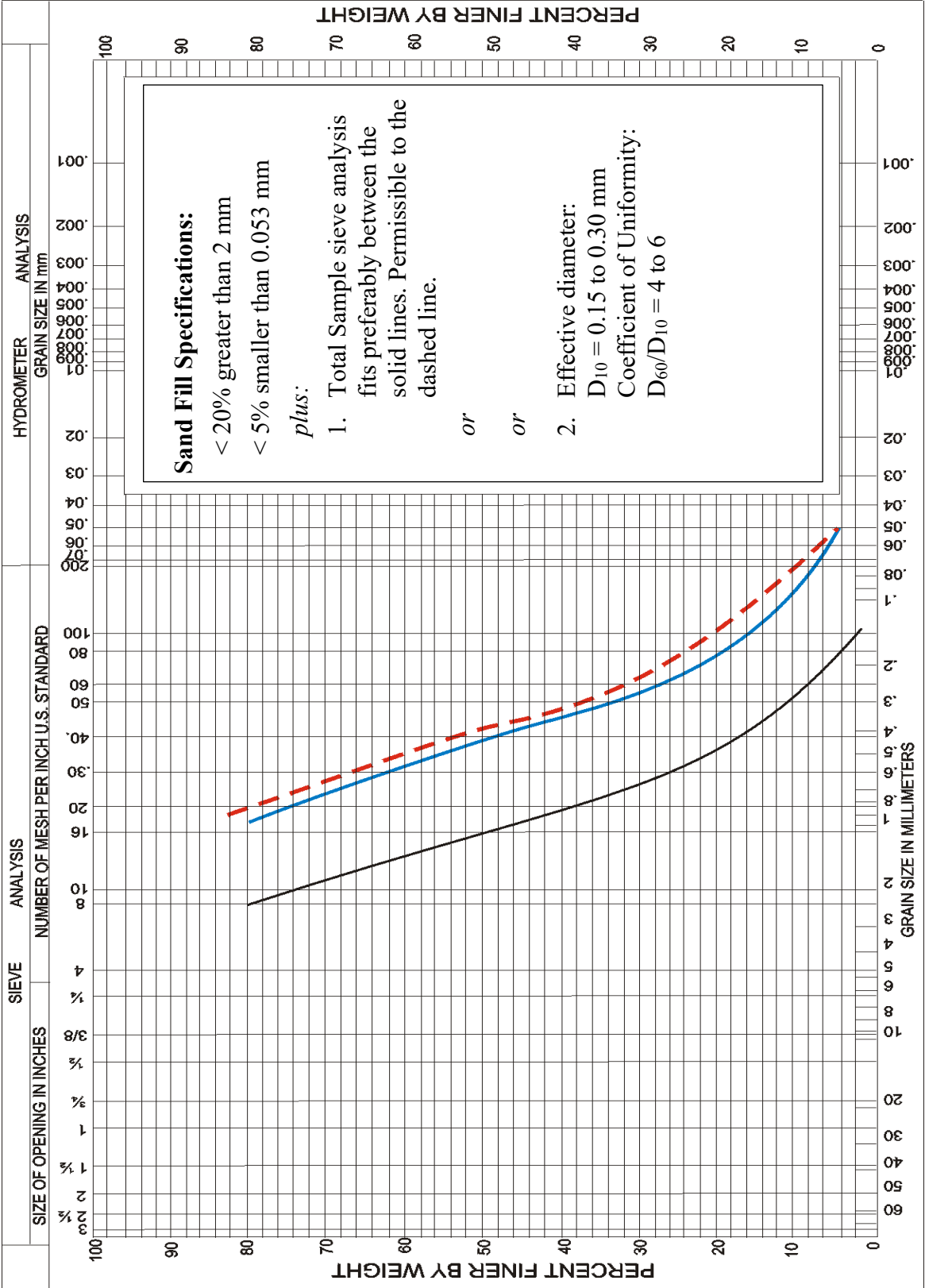

Figure 27.F Wisconsin Mound Sloping Site Detail

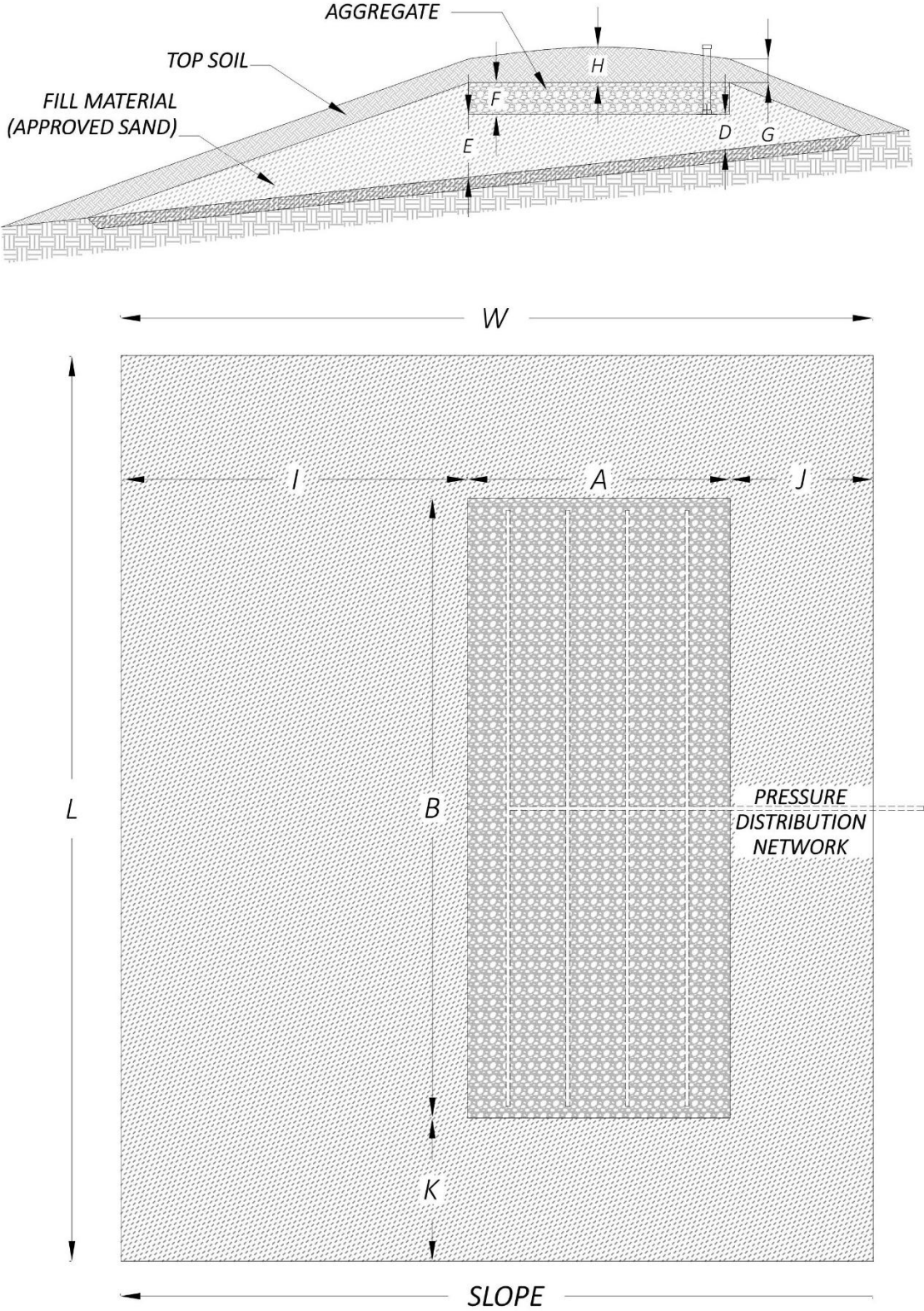

Figure 28.F Wisconsin Mound Level Site Detail

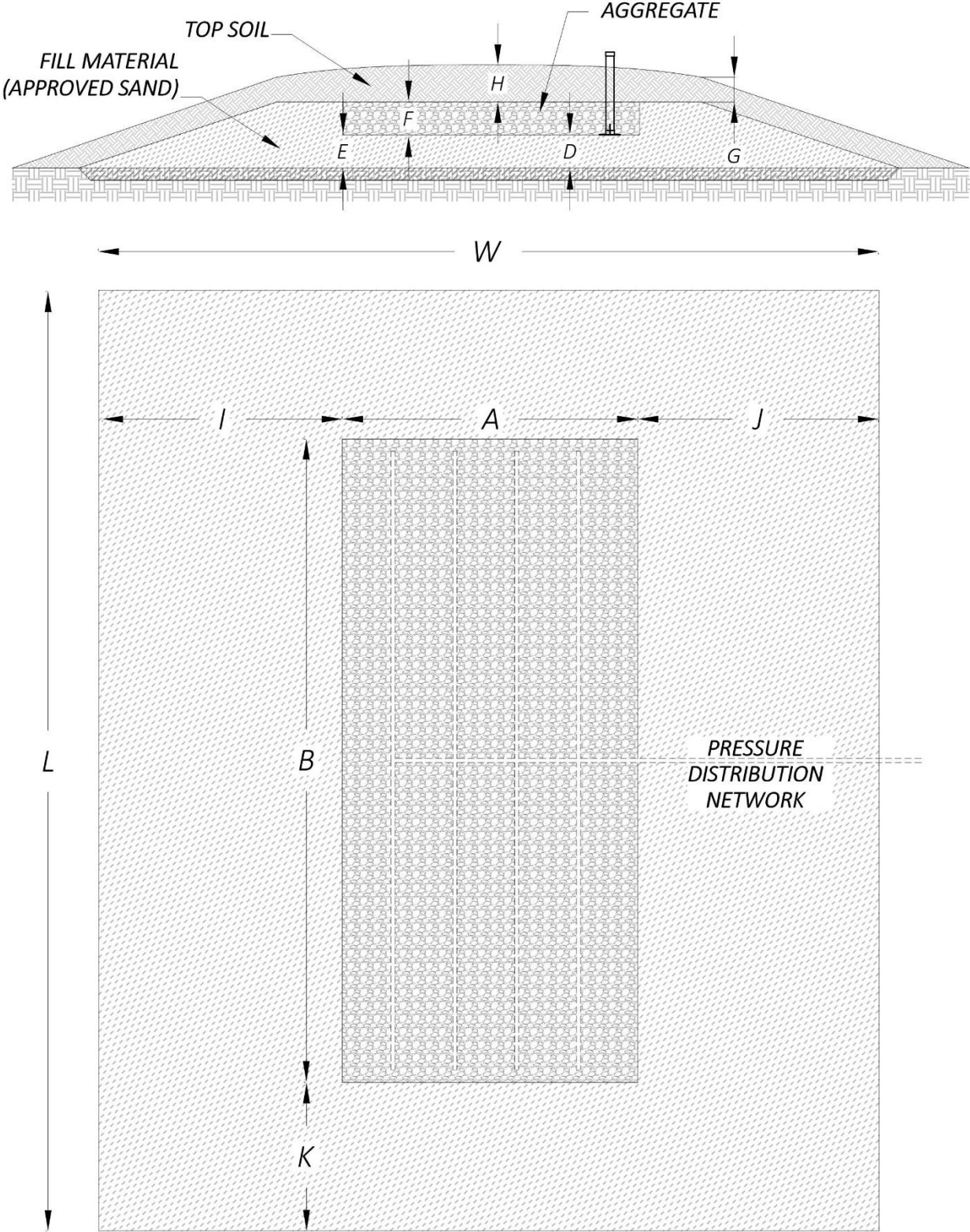
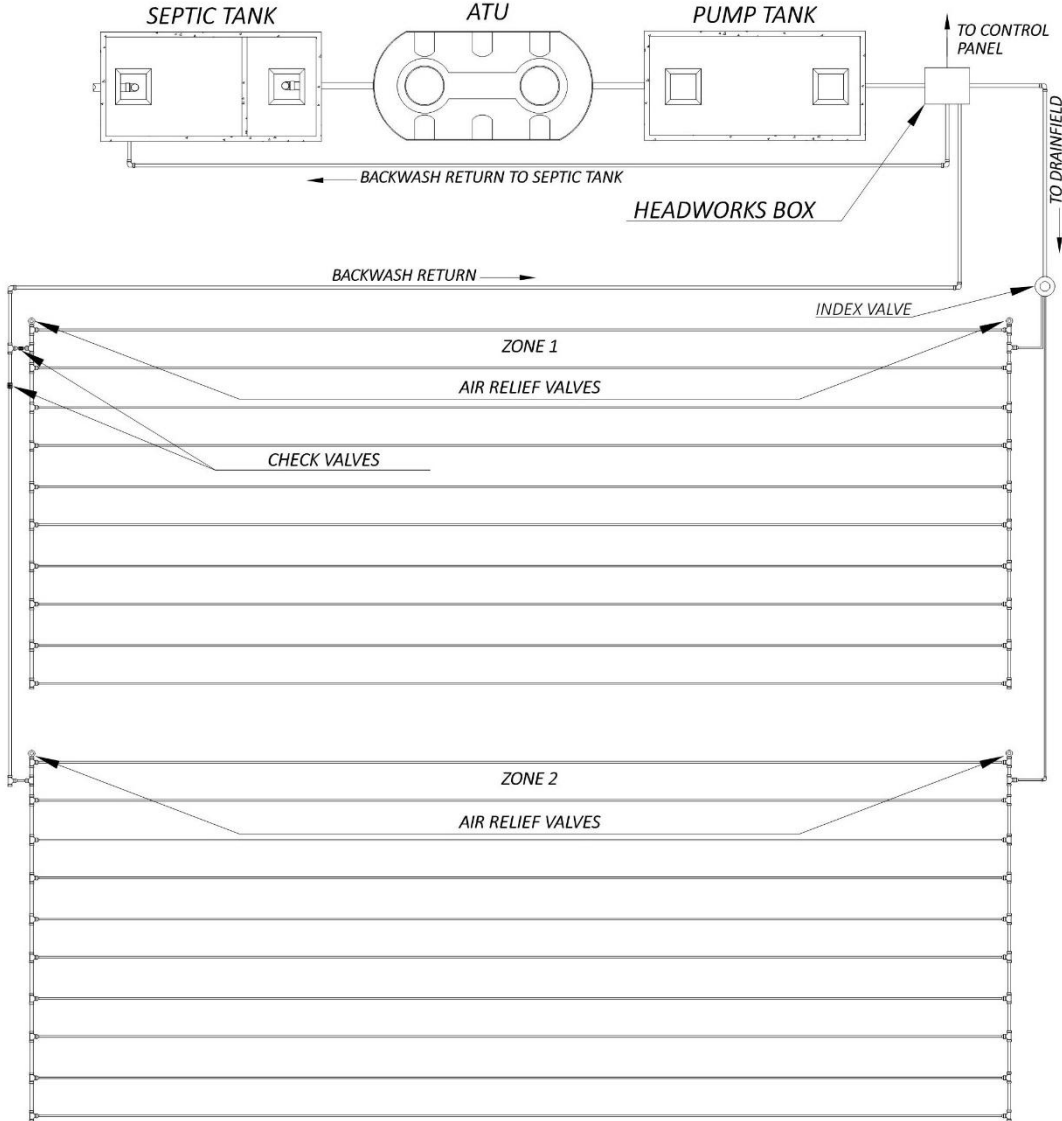
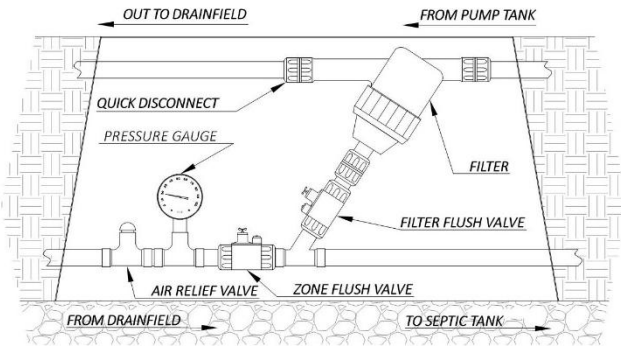

Figure 29.F Drip Emitter System Detail



HEADWORKS BOX DETAIL



**Form 7.F Wisconsin Mound System Worksheet**

Wisconsin Mound System Worksheet (refer to Figures 27.F and 28.F)		
Parameter		Value
1.	Determine <b>design flow rate</b> (gallons/day)	
2.	Determine the <b>basal loading rate</b> (gallons/day/square foot) <i>(This information must be provided by a qualified Soil Classifier)</i>	
3.	Determine the <b>linear loading rate</b> (gallons/day/linear foot) Note: the size and configuration of the mound is based on how the effluent moves away from the system and the rate at which it moves away from the system. <ul style="list-style-type: none"> <li>• Good soil structure, good permeability – vertical flow 8-10 gpd/lf</li> <li>• Poor soil structure, slow permeability – horizontal flow 3-4 gpd/lf</li> </ul> <i>(This information must be provided by a qualified Soil Classifier)</i>	
4.	<b>Sand fill design loading rate</b> – 1.0 gpd/ft <sup>2</sup> <i>(A Soil Classifier must certify the fill material as meeting the requirements in the Manual)</i>	
5.	Determine the absorption area width ( <b>A</b> ), where: $A = \text{linear loading rate} / \text{sand fill loading rate}$	
6.	Determine the absorption area length ( <b>B</b> ), where: $B = \text{design flow rate} / \text{linear loading rate}$	
7.	Determine the basal width ( <b>A + I</b> ), where: $A + I = \text{linear loading rate} / \text{basal loading rate}$	
8.	Determine mound fill depth ( <b>D</b> ), where: $D = 24'' - (\text{depth to shallow water table from original ground surface})$ <i>(Note: Code requires 2 feet of separation from bottom of absorption trench/bed and seasonal high water table.)</i>	
9.	Determine mound fill depth ( <b>E</b> ), where: $E = D + (\% \text{ slope in area of mound footprint}) A$	
10.	Determine mound depths ( <b>F</b> ), ( <b>G</b> ), and ( <b>H</b> ), where: $F = \text{absorption trench/bed aggregate depth, and}$ $G = \text{fill cover depth, and}$ $H = \text{fill cover depth} + \text{top soil depth}$	
11.	Determine mound upslope width ( <b>J</b> ), where: $J = 3 (D + F + G)$ <i>(Note: A maximum mound side slope of 3 to 1 is required)</i>	
12.	Determine mound end-slope length ( <b>K</b> ), where: $K = 3 ( (D + E) / 2 + F + H )$	
13.	Determine downslope width ( <b>I</b> ), where: $I = 3 (E + F + G)$ <i>Note: Compare (I) with calculation from step 7. Use the largest number for downslope width. A maximum mound side slope of 3 to 1 is required)</i>	
14.	Determine overall mound length ( <b>L</b> ) and width ( <b>W</b> ), where: $L = B + 2K$ , and $W = A + I + J$	

**Form 8.F Engineered Site Plan Check sheet**

<b>GEORGIA DEPARTMENT OF PUBLIC HEALTH</b> <b>OSSMS Engineered Site Plan Check sheet</b>	
<p>A site plan may be required when more information and detail is needed to determine compliance with the regulations. Sites with marginal soil conditions, restrictive topographic features or other factors that limit the amount of suitable area available for the installation and replacement of an on-site sewage management system may require an engineered plan from a State Registered Engineer. The following requirements will determine compliance with the state regulations. The site plan must include the following:</p>	
	Site plan drawn to a minimum 1" to 40' scale.
	Topographic delineations on 2-foot contours showing existing and/or finish grades.
	Location and dimensions of residence (s) or building (s), including setback distances from property lines.
	Location of driveway (s), paved areas, pools, and other structures.
	Location of underground utility lines, water lines or wells (on or within 100 ft. of the property).
	Location of streams, lakes, bodies of water, drainage ways, easements, wetlands or floodplains on property.
	Finish floor elevations, including basement.
	Elevation and location of plumbing stub-out.
	Scaled drawing of the on-site sewage management system including replacement area. Drawing to include primary treatment (septic tank or aerobic treatment unit), dosing/pump tank (if applicable), and absorption field layout (including type and size). Pump size and manufacturer, including pump calculations (if applicable).
	A Level 3 or Level 4 soil report (as applicable) and map overlaid on the site plan. Absorption fields within 20 feet of soil transition lines shall be verified by the Soil Classifier for accuracy.
	Engineered site plans shall bear the seal and signature of the designer and include the following statement: I certify this on-site sewage management system meets the minimum design requirements established by the Department of Public Health. I have made a site visit to verify the system can be installed as designed in accordance with these regulations.
<p>Comments:</p>	
Environmental Health Specialist:	Date:
<p><b><i>Site plans with deficiencies shall be returned to the engineer within 3 working days with the deficiencies noted and the process of appeal.</i></b></p>	



# Manual for On-Site Sewage Management Systems

SECTION G | EXPERIMENTAL SYSTEMS

Environmental Health Section

**SECTION G - EXPERIMENTAL ON-SITE SEWAGE MANAGEMENT SYSTEMS****1) Definition**

An Experimental On-site Sewage Management System is defined as “any on-site sewage management system proposed for testing and observation and provisionally approved for such purpose by the Department but which has not been fully proven under field use.”

**2) Request for Approval**

Manufacturers shall make application to the Department for an individual experimental on-site sewage management system (experimental system) temporary approval for the installation of a limited number of systems to be evaluated over a prescribed period of time. The application shall include the following as applicable:

- A. Remittance of the current fee for the technical review of new on-site sewage management products/systems.
- B. Description of the system, including materials used in construction and its proposed use.
- C. Summary of pertinent literature, published research and previous experience and performance with the system.
- D. Results of any available testing, research or monitoring of pilot systems or full-scale operational systems conducted by a third-party research or testing organization.
- E. Identification and the qualifications of any proposed research or testing organization and the principal investigators, as well as an affidavit certifying that the organization and principal investigators have no conflict of interest and do not stand to gain financially from the sale of the experimental system.
- F. A monitoring protocol, outlining a research and testing plan for a representative number of installations. The protocol shall include a defined list of objectives, parameters to be monitored and test methodology, data collection and reporting forms and a schedule for the completion of the outlined activities. The minimum period of research, testing and monitoring is three years.
- G. Specification of the number of systems proposed to be installed, the criteria for site selection, system monitoring and reporting procedures.
- H. Operation and maintenance procedures, system classification, proposed management entity and system operator.
- I. Procedure to address system malfunction and replacement or premature termination of any proposed research or testing.
- J. Notification of any proprietary information system, component or device.

**3) Technical Review**

The Technical Review Committee (the Committee) shall review applications for such proposed experimental systems and upon their recommendation, the Department may forward an

experimental system temporary approval and system registration to the manufacturer. A copy of this approval will be distributed to all District Environmental Health Program Directors. The approval will indicate the conditions under which a limited number of a given type of experimental system may be installed as outlined in applicable parts of section 2B through 2J above. No more than ten experimental systems of one individual type system will be allowed to be installed in each District, unless the Committee specifies a greater or lesser number may be allowed.

#### **4) Permitting**

Property owners, authorized distributors or installers shall make an application for each installation of an approved experimental system to the County Environmental Health Office. In addition to documentation required by Chapter 511-3-1-.03 (2), the Committee and the Manual, the application will include a consent letter from the property owner or authorized agent, on forms provided by the Department, acknowledging the experimental nature of the system and holding the Georgia Department of Public Health and cooperating County, District and State personnel harmless regarding the installation or use of an experimental system. The property owner or authorized agent shall agree to allow the distributor, installer and environmental health personnel from the County, District and State, access to the site at reasonable hours to evaluate the functioning of the system.

The County Environmental Health Office will evaluate the permit application, which must include data on soils acceptability; such data may include but not be limited to: test holes, percolation tests and soil report (s) by a Certified Soil Classifier. An on-site evaluation will be performed, and a proposed experimental system installation permit developed for each proposed installation site.

When permitting installation of the experimental system, the permit conditions shall include the requirement of a reserve area sufficient for installation of a conventional system, except:

- A. When an existing and properly functioning wastewater system is available for immediate use including connection to a public or community wastewater system; or
- B. When the experimental system is to serve as a repair to an existing malfunctioning system.

The special maintenance, monitoring, testing and reporting requirements shall also be specified as permit conditions, in accordance with the research and testing program/protocol approved by the Committee. All required review documentation will be forwarded along with the proposed installation permit to the District for approval.

The District shall approve or deny requests for individual installations of approved experimental systems based on the review of the required information. Once three installations of a given type of experimental system have been permitted, the District may delegate approval to the County for subsequent permit approvals. Approval or denial shall be issued within ten days of the receipt of the complete review information.

The County will issue an installation permit once it is signed by the permit applicant, and payment of appropriate County permitting fees have been received; only then can construction of the experimental system begin.

#### **5) Installation**

The manufacturer will identify its distributors and installers in the state of Georgia that have been instructed and trained on the installation, operation and maintenance of the experimental system. Installers shall be certified in accordance with 511-3-1-.16. Certified installers shall be the ONLY personnel approved to install experimental systems. Failure to carry out the installation permit conditions shall be grounds for permit suspension or revocation. The County staff will inspect the installation of the experimental system. Once final approval has been granted to the installation, a copy of the completed inspection documentation will be forwarded through the District to the Department. Repairs or modifications to an approved experimental system installation must be recorded and reported by the manufacturer to the County for issuance of an appropriate repair permit, inspection and approval of the repair (s).

#### **6) Record Keeping**

The Department, District and County will maintain a separate filing system and database to track experimental system installations.

#### **7) Monitoring and Testing**

As indicated in Section 3 above, the Committee will approve design of a monitoring, testing and reporting protocol as appropriate for each approved experimental system. The Department, District and County, as applicable, shall implement the protocol. Unless otherwise approved by the Committee, no more than ten of a given experimental system will be allowed to be installed in each District during this monitoring and testing period.

#### **8) Final Disposition**

Upon completion of the monitoring, research and testing, the manufacturer or appropriate research and testing organization or individual and appropriate District and County Environmental Health Offices, shall provide a final report including recommendations on future use of the system to the Committee for review. Based upon the Committee's action, the Department may issue a final disposition on the status of the experimental system. This will consist of, but not necessarily be limited to, denial or approval as an alternative on-site sewage management system for statewide use.

**9) Table, Figures and Forms**

**Form 9.G Administrative and Monitoring Criteria for an Experimental Sewage System**

The undersigned, in support of the attached proposal to use a(n) \_\_\_\_\_  
 (System Type)  
 experimental sewage system (ESS) to serve the property at, \_\_\_\_\_  
 (Address)  
 \_\_\_\_\_, submits the following:  
 (Municipality/City) (State) (County)

This proposal is for a full-time, single family residential or other property. It is not for a seasonal, part-time or recreational use structure.

As owner of the property to be served by a(n) experimental sewage system. I acknowledge the importance of conducting the monitoring, reporting and maintenance activities in a timely fashion and accept responsibility for performing these activities for a period of three (3) years from the date of system installation and start-up. I realize that the monitoring program is a condition of the permit, which is enforceable by law.

The monitoring program for this system shall consist of the following activities:

- (1) Determining whether the observation ports contain ponded liquid and recording these results;
- (2) Measuring and recording the depth of any liquid in the ports;
- (3) Conducting a visual examination of the areas immediately adjacent to and down slope of the experimental sewage system for seepage, sponginess, leakage or any other evidence of discharge of liquid from the experimental sewage system; and recording and reporting the results of this examination on the monitoring report form included in this proposal (Form 8.G);
- (4) Recording monthly water usage data (gallons);
- (5) Performing the activities in 1, 2, 3, and 4 above monthly and submitting a report to the County Environmental Health Program Director (CEHPD) with a copy forwarded through the District Environmental Health Office to the Department every three months (quarterly).

I am aware that this is an experimental system that may fail and that in the event this system malfunctions, I am solely responsible to replace or repair the system in accordance with the replacement provision of this proposal. (See Plot Plan for replacement area location and provisions for its protection).

I acknowledge my responsibility to inform the CEHPD immediately of any malfunction or modification of the system by others or myself.

As owner of the property, I grant environmental health personnel from the County, District and Department access to my property for the purpose of conducting additional testing, observation and monitoring for the duration of the experiment proposal (three years from the date of system activation).

Further, I agree to notify the CEHPD at least seven days prior to system installation so the District and Department may observe and monitor the system installation.

The septic tanks, which are part of this experimental sewage system, will be pumped at least once, during the last quarter of the third year, to prolong system life. Evidence, in the form of a receipt from the septic tank pumper, that the pumping has been performed will be submitted with the last quarterly monitoring report at the end of the third (3rd) year.

\_\_\_\_\_  
 Property Owner

\_\_\_\_\_  
 Application Date

**Form 10.G DPH Experimental Sewage System Monitoring Record**

Property Owner:				Installation Date:					
Address of System:				Type of System:					
Instructions: Record all information each month, use the comments column to record maintenance activities, locations of surface discharge of sewage effluent or describe unusual conditions.									
Observation Date (mo/day/yr)	Liquid Seepage Over Trench or Down slope?		Observation Ports – Liquid Levels						Comments
	Yes	No	Port #1			Port #2			
			No	Yes	Depth (Inches)	No	Yes	Depth (Inches)	
Note: Monitoring and reporting of results from this experimental system is a permit condition enforceable by law. Each quarter (every three months) for three years from the time of installation, a completed copy of this form must be submitted to the following offices:									
Office			Name			Address			
County Environmental Health Program Director									
District Environmental Health Program Director									
Georgia Department of Public Health Land Use Program						Environmental Health Section 2 Peachtree Street, NW, 13 <sup>th</sup> Floor Atlanta, GA			



# Manual for On-Site Sewage Management Systems

## SECTION H | SITE MODIFICATIONS

Environmental Health Section

---

## SECTION H – SITE MODIFICATIONS

### 1) General Guidelines for Filling of Land

- A. *Uniformity of Fill Materials* - Any variability of the fill material used for absorption of sewage effluent will likely cause problems for on-site sewage management systems. Fill must not include stumps, logs, rocks, brick, concrete or extraneous materials. Fill material must meet ASTM C-33 Specifications for Fine Aggregate with less than five percent passing a number two hundred sieve. Other fill materials may be acceptable, however, they must have a permeability of between 0.0005 meters per second (m/sec) and 0.00003 (m/sec) at ninety-five percent Standard Proctor Compaction. The simplified falling head permeability test procedure as described in Section H.8 or other ASTM approved testing procedures may be used for determining permeability of fill.
- B. *Compaction of Fill* - Fill material must be compacted to a density of undisturbed soil in the proposed absorption field area (90% Standard Proctor Compaction) before the installation of an on-site sewage management system can be allowed. This can be done naturally or mechanically. The fill material should be placed in lifts not exceeding 12 inches loose thickness and compacted to the density specified. The County Board of Health may require a Standard Proctor Compaction test.
- C. *Original Soil Surface to be Plowed* - Heavy topsoil, black or very dark gray organic topsoil, and vegetation must be removed from the fill site area and the exposed underlying soil plowed to prevent formation of an impervious barrier between the fill and natural soil. Plowing of the original soil shall be done only while dry to a depth of six to eight inches, throwing the soil toward the center of the area to be developed. The proper soil moisture must be such that the soil will crumble and not take on a wire form when rolled between the palms. A mold board plow, chisel plow, or chisel teeth mounted on a tool bar attached to the bucket of a backhoe can be used. The backhoe bucket teeth are not satisfactory and must not be used. Once the site is tilled a layer of sand must be placed before it rains on the tilled area. Placement of the fill must be such as not to rut up or compact the tilled area. All work must be done from the up-slope side, so as not to compact the down slope area. Fill should be placed with a backhoe or moved around the site with a track type tractor. Wheeled tractors will rut up the site.
- D. *Topsoil Cover and Grass* - A minimum of six inches of a suitable topsoil material shall be placed over the filled area so grass or other suitable vegetation can be established. The area must be seeded and mulched to avoid erosion before the site can be approved.
- E. *Fill Area Sizing and Drainage* - There must be a minimum five feet separation between the shoulder of the fill and the nearest absorption trench. The slope of the fill material from the shoulder to the toe of the fill must have a minimum of a five to one slope. There must be at least a one percent slope from the center of the filled area to the shoulder so water will not pond on top of the filled area. Swales and/or other suitable drainage devices shall be used to divert any storm water away from the filled site area.
- F. *Sizing and Placement of Absorption Trenches in Fill* - The sizing of absorption trenches shall be based on the most restrictive texture encountered within twelve (12") inches of the

original soil surface. Absorption trenches must be installed across the contours of the original site slope.

- G. *Certification of Filled Site* - A Soil Classifier, Registered Engineer or Registered Geologist must submit a statement to the Board of Health certifying that the in-place fill and the filled site meet requirements of these guidelines or with Board of Health approval a Level II Certified Environmental Health Specialist trained in fill evaluation may approve in-place fill meeting these guidelines.
- H. *Restrictions on the Use of Area Fill* - The minimum depth of original soil to the seasonal high groundwater table, rock or other restrictive soil horizon shall be twelve (12") inches. The maximum permeability of the top 12 inches of original soil shall be 30 minutes per inch. Area fill should not be used on sites with slopes that exceed 12%.

## 2) General Guidelines for Drainage of Land

General guidelines for the drainage of land for on-site sewage management are more complex because of the multiplicity of possibilities for design and the potential for intercepting sewage-contaminated water flowing laterally from the absorption field. Drainage is commonly accomplished by either surface drainage or by internal drainage (subsurface drainage).

- A. *Surface Drainage* - This method is often used for handling storm water runoff and should be an important part of any site plan where surface water is expected to pose a problem either by ponding on-site or by flowing across the property. Any plan for surface drainage should be developed under the supervision of the appropriate local governing body having responsibility for approving drainage plans. Along with appropriate property easements obtained, there should be provisions for proper installation and continued maintenance of the drainage facilities since lack of maintenance often allows the drainage ways to become clogged with debris, silt, vegetative growth, etc., to the point where conditions are as bad or worse than before the drainage improvement was installed. Surface drainage is often effective in reducing the length of the period of saturation on a site, but is usually not adequate to prevent temporary saturation with resulting localized malfunctioning of absorption fields.
- B. *Subsurface Drainage (Internal Drainage)* - The removal of excess soil water from seasonal high water table elevations or soil saturation caused by natural precipitation is often crucial to proper absorption field operation. In some cases, this may be corrected by installing subsurface drain networks which remove the excess water as it flows laterally into the drains usually resulting in some lowering of the water level. If the water level can be lowered significantly and to the point where there is vertical separation of the proposed absorption field trench bottoms and the water level, subsurface drainage may be an approvable modification. Many interrelated factors come into play in any drainage plan. Probably the most important variables include: the depth of permeable soil and homogeneity of the soil to be drained, depth of water table, availability of gravity flow outlets and frequency of in station of subsurface absorption lines. Any subsurface drainage plan must be prepared and the installation approved by a Soil Classifier, Agricultural Engineer or other design professional competent in the design of subsurface drainage systems.

- C. Subsurface drainage must be located 10 feet up gradient or 30 feet down gradient from any absorption trench.

### 3) Artificially Drained Systems

High water tables that limit the use of absorption trenches can sometimes be artificially lowered to permit the use of this disposal method. Vertical drains, curtain drains and under drains are commonly used subsurface drainage techniques. Soil and site conditions determine which method is selected (see Table 12.H). Successful design of artificially drained systems depends upon the correct diagnosis of the drainage problem. The source of the groundwater and its flow characteristics must be determined to select the proper method of drainage. Particular attention must be given to soil stratification and groundwater gradients. Because each of these drainage problems requires different solutions, it is important that the site evaluation be done in sufficient detail to differentiate between them. Where the need for subsurface drainage is anticipated, topographic surveys, soil profile descriptions and estimation of the seasonally high groundwater elevations and gradients should be emphasized. Evaluation of these site characteristics must be done in addition to evaluation of other site characteristics affecting surface disposal.

### 4) Subsurface Drainage Problems

There are an unlimited variety of subsurface drainage problems, but the most common ones can be grouped into four general types. These are: (1) free water tables, (2) water tables over artesian aquifers, (3) perched water tables, and (4) lateral groundwater flow problems.

- A. *Free Water Tables* - Free water tables typically are large, slow-moving bodies of water fed by surface waters, precipitation, and subsurface percolation from other areas. In the lower elevations of the drainage basin, the groundwater is discharged into streams, on the ground surface in low areas, or by escape into other aquifers. The groundwater elevation fluctuates seasonally. The slope of a free water table surface is usually quite gentle. Where the soil is permeable, under-drains can be used to lower the water table sufficiently to permit the installation of trench or bed disposal systems. In fine textured soils of slow permeability, however, subsurface drainage is impractical.
- B. *Water Table Over Artesian Aquifer* - An artesian aquifer is a groundwater body confined by an impervious layer over the aquifer. Their pressure surfaces (the elevation to which it would rise in well tapping the aquifer) are higher than the local water table and may even rise above the ground surface. Pressure in the aquifer is caused by the weight of a continuous body of water that is higher than the local water table. Leaks at holes or weak points in the confining layer create an upward flow, with the hydraulic head decreasing in the upward direction. The groundwater moves in the direction of the decreasing gradient and escapes as seepage at the ground surface or moves laterally into other aquifers. Areas with this problem are impractical to drain. The water removed is continually replenished from the aquifer. This requires relatively deep and closely spaced drains and pumped discharges. On-site disposal options should be investigated in areas with shallow artesian aquifers.

- C. *Perched Water Table* - In stratified soils, a water table may develop that is separated from the free water table by a slowly permeable layer, i.e., a perched water table. This occurs when surface sources of water saturate the soil above the layer due to slow natural drainage. Methods employed to drain perched water tables depend upon the particular site conditions. Vertical drains, curtain drains or under drains may be used. Subsurface drainage may be impractical in fine textured soils of slow permeability.
- D. *Lateral Groundwater Flow* - Lateral groundwater flow problems are characterized by horizontal groundwater movement across the area. This flow pattern is usually created by soil stratification or other natural barriers to flow. The depth, orientation and inclination of the strata or barriers determine the drainage method used and its location. Curtain drains or vertical drains are usually employed to intercept the water upstream of the area to be drained.

## 5) Selection of Drainage Method

In designing a subsurface drainage system, the site characteristics are evaluated to determine which method of drainage is most appropriate. Table 11.H presents the drainage method for various site characteristics. In general, shallow, lateral flow problems are the easiest drainage problems to correct for subsurface wastewater disposal. Since the use of the under drains for onsite disposal systems has been very limited, other acceptable disposal methods not requiring drains should first be considered.

- A. *Curtain Drains (See Figure 30.H)* - Curtain drains are placed some distance up slope from the proposed soil absorption system to intercept the groundwater, and around either end of the system to prevent intrusion. On sites with sufficient slope, the drain is extended down slope until it surfaces, to provide free drainage. The drain is placed slightly into the restrictive layer to ensure that all the groundwater is intercepted. A separation distance from the soil absorption system is required to prevent insufficiently treated wastewater from entering the drain. This distance depends upon soil permeability and depth of drain below the bottom of the absorption system; however, a separation distance of 10 feet is commonly used. The size of the drain is dependent upon the soil permeability, the size of the area drained, and the gradient of the pipe. Silt traps are sometimes provided in the drain to improve the quality of the discharged drainage. These units may require infrequent cleaning to maintain their effectiveness.
- B. *Vertical Drains (See Figure 31.H)* - Vertical drains may be used to intercept a laterally flowing perched water table. Separation distances between the drain and the bottom of the absorption field are the same as for curtain drains to maintain an unsaturated zone under the absorption field. The size and placement of the drain depends upon the relative permeability of the saturated soil and the soil below the restrictive layer, and the size of the area to be drained. The infiltration surface of the vertical drain (side walls and bottom area) must be sized to absorb all the water it receives. The width and depth of the drain below the restrictive layer is calculated by assuming an infiltration rate for the underlying soil. If clay and silt are transported by the groundwater, the infiltration rate will be less than the saturated conductivity of the soil. Clogging of the vertical drain by silt can be a significant problem. Unfortunately, experience with these drains in wastewater disposal is lacking.

- C. *Under Drains (See Figure 32.H)* - Under drains are used to lower the water table when the table is 4 to 5 ft. (1.2 to 1.5m) below the surface in permeable soils. This also provides the necessary depth of unsaturated soil below the infiltrative surface of the soil absorption system, and to prevent poorly treated effluent from entering the drain. Sometimes, a network of drains is required throughout the area where the absorption field is located. The depth and spacing of the drains is determined by the soil permeability, the size of the area to be drained, and other factors.

## 6) Mound System Modification

When slowly permeable soils exist and or rock formations or high, ground water elevations prohibit issuance of permits for conventional on-site sewage management systems, a mound system may be considered. Construction of such systems shall be in accordance with design standards found in the "Wisconsin Mound Soil Absorption System Siting, Design and construction Manual, January, 1990 edition. See Section F for a copy of this design manual and other acceptable pressure dosing alternatives. Site preparation and suitability of the in-place fill materials used must be certified by a Soil Classifier, Registered Engineer or Registered Geologist as meeting the above criteria before on-site sewage management construction permits can be issued by the Board of Health.

## 7) Alternative Distribution System Specifications

The distribution system in an elevated sand mound shall consist of three components:

- A. Pressurized distribution manifold - that shall consist of a small diameter (1" - 1.5") schedule 40 pipe, to receive the effluent from the pump. This pipe shall be connected as to not create any dead ends, and shall have 3/8" holes drilled in it every 36" pointing up. The effluent from the pump must come to the center of this distribution manifold and absorption area.
- B. Field drainpipe to house the pressurized distribution manifold - A 4" field line pipe with the holes pointing down is acceptable. Other field drainpipe designs may be acceptable, but first must go through the experimental protocol.
- C. Distribution media - 1/2" to 2" gravel to a depth of 1ft. is acceptable. The design of the absorption area must comply with design guidelines for gravel underground absorption. If other distribution media are approved, they must comply with the appropriate regulations and guidelines.

## 8) Simplified Falling-Head Permeameter Test for Fill Material for Disposal Fields

The permeameter consists of an acrylic glass clear plastic tube with one end covered by a fine mesh screen. The cylinder is stood in a low plastic container with a layer of filter fabric at the bottom to allow free exit of permeating water. The details and general arrangement of the apparatus are shown in Figure 34.H. Approximately 60 mm. of the sand to be tested are filled into the cleaned cylinder and compacted by allowing the cylinder to fall 200 mm. five times onto the workbench. More sand is added to the 110 mm. mark and again compacted. The cylinder is then placed in the container and the sand flooded from the bottom up to drive out any air. After allowing the wet sand to drain excess water, the sample is again compacted by dropping five times and the sample is trimmed to a finished height of 100 mm. using a suitable

scraper. The cylinder is now returned to the container, flooded from the bottom up and then water is carefully poured into the top of the cylinder above the upper reference mark. The water level is now allowed to fall, noting the time in minutes that it takes to pass over the 50 mm. gauge length. Measure or judge the temperature of the water used in the test. Now refer to the chart in Figure 35.H to determine the apparent permeability.

## 9) Tables, Figures and Forms

**Table 11.H Drainage Methods for Various Site Characteristics**

<b>Drainage Problem</b>	<b>Site Characteristics</b>	<b>Drainage Method</b>
Free Water Table	Deep uniform soils	Underdrain <sup>2</sup>
Artesian-Fed Water Table	Saturated soils above and below a restrictive layer with hydraulic gradients increasing with depth	Avoid
Perched Water Table	Saturated or mottled soils above a restrictive layer, soil below restrictive layer is unsaturated; site is level or only gently sloping	Underdrain <sup>2</sup> Vertical Drain <sup>1</sup>
Lateral Flow	Saturated or mottles soils above a restrictive layer with water source located at a higher elevation; site usually sloping	Curtain Drain Vertical Drain <sup>1</sup>
<sup>1</sup> Use only where restrictive layer is thin and underlying soil is reasonably permeable.		
<sup>2</sup> Soils with more than 70% clay are difficult to drain and should be avoided.		

**Table 12.H Use of Subsurface Drains to Control Ground Water Table**

Suitable Soils to Place Subsurface Drains (Inches)	Soil Series*	Depth to shallow water table (Inches)	Depth of Water Table After Drainage (Inches)			
			Drain Spacing 120 ft.	Drain Spacing 100 ft.	Drain Spacing 70 ft.	Drain Spacing 50 ft.
60	Chipley Lynn Haven Ousley Leon Mandarin St. Johns	24	48	50	54	55
50	Albany Goldsboro Izagora Johns Lynchburg Ona Plummer Sapelo	24	39	40	41	42
40	Leefield Mascotte Ocilla Olustee Pelham Rains Rigdon Stilson	24	30	33	35	36
36	Clarendon Irvington Hazlehurst	24	22	23	24	26
*Suitable-sandy or loamy soils (5 to 35 percent clay)						

**Figure 30.H Curtain Drain Detail**

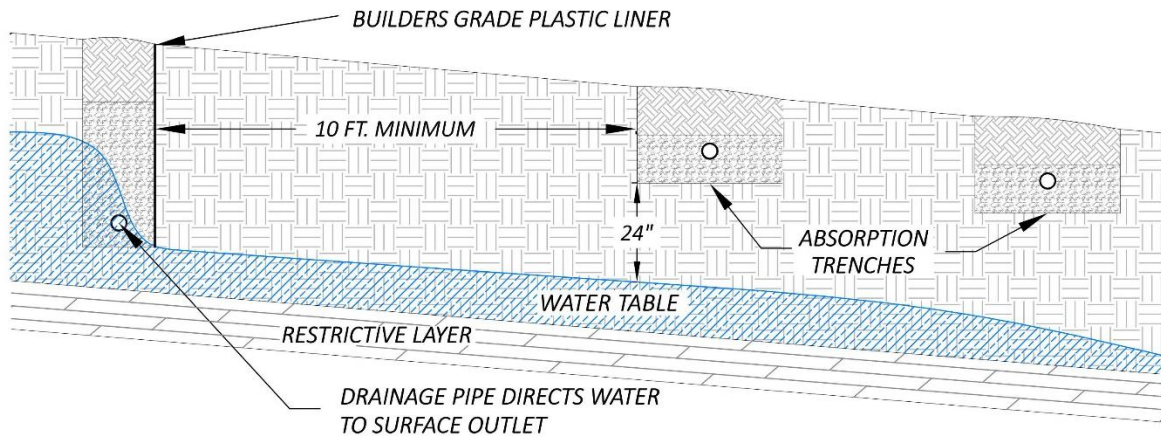

**Figure 31.H Vertical Drain Detail**

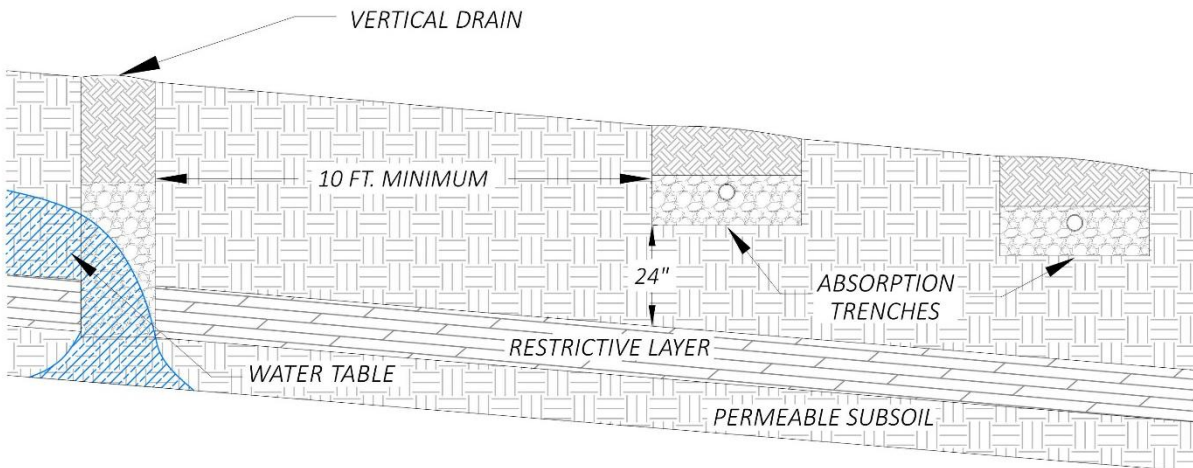

**Figure 32.H Underdrain Detail**

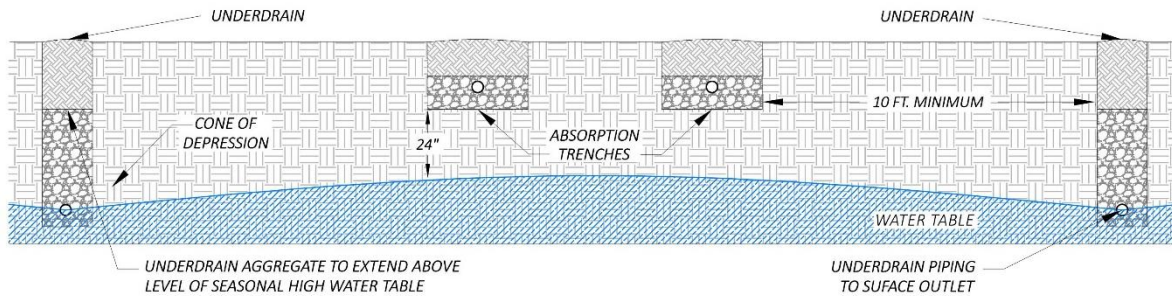

**Figure 33.H Side View of Piping Distribution System in a Wisconsin Mound**

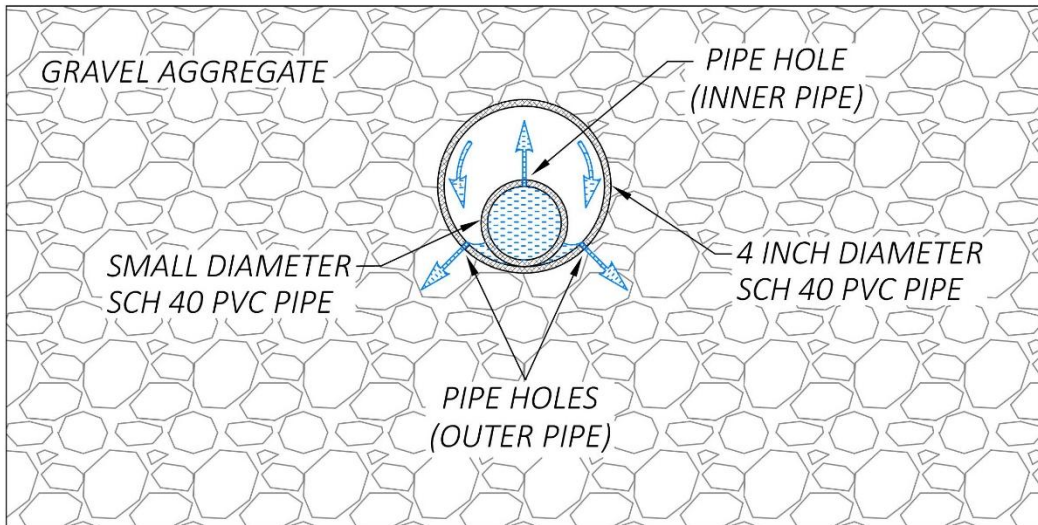

**Figure 34.H Falling Head Permeameter Apparatus**

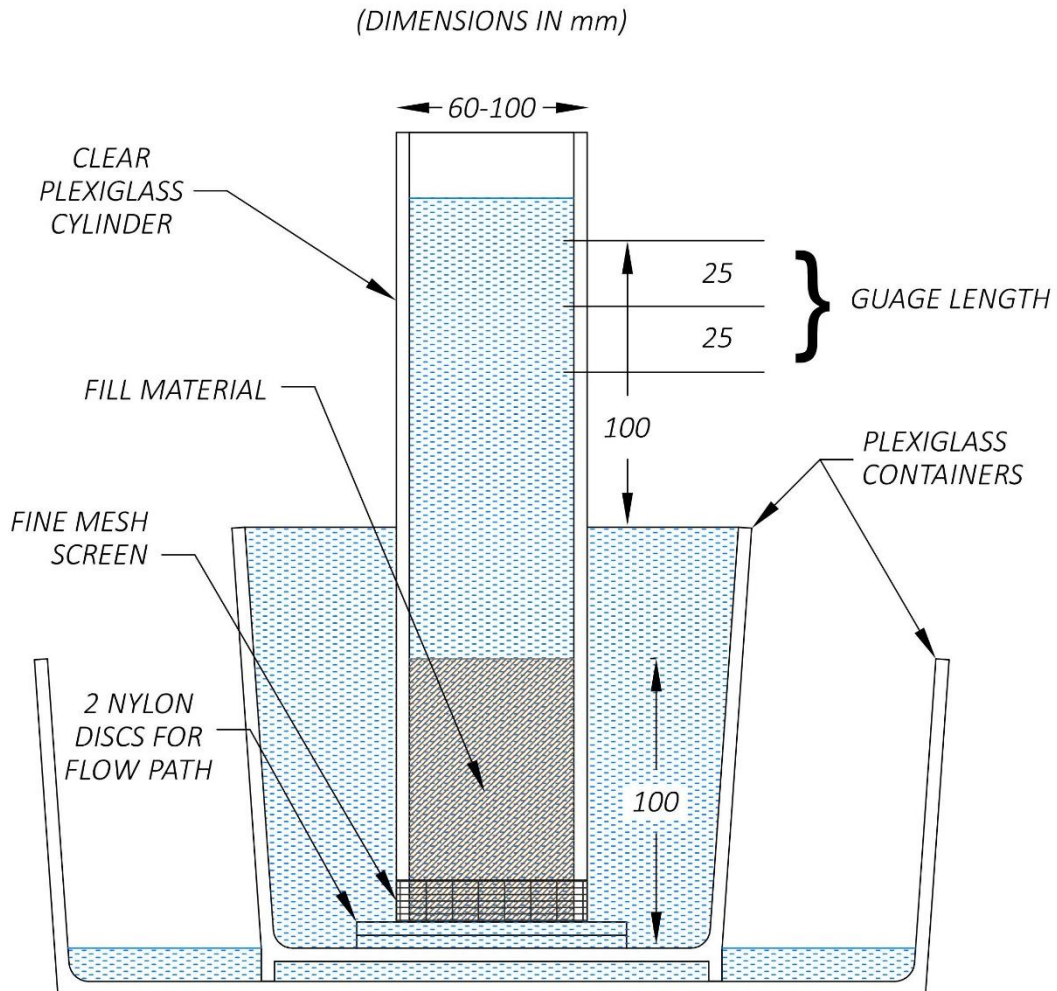

**Form 11.H OSSMS Filled Site Certification Form**

Property Owners Name:		
Location and Address of the Property:		
1. Topsoil and vegetation has been removed from the entire filled area	Yes	No
2. Entire filled area has been properly tilled	Yes	No
3. The fill material used on the site is coarse/medium sand that meets fill regulations in the Manual	Yes	No
4. The proper amount of fill material has been properly placed on the site to construct the absorption field area to comply with distance regulations for the slope fringe area	Yes	No
5. The filled area has been properly constructed and has a 5 to 1 slope	Yes	No
6. Is there proper surface water control around the filled site? (i.e. swales, gutters on house, ditches, or other methods specified for proper drainage)	Yes	No
7. Is there enough good quality topsoil on the site to be used as six inches of cover on the entire absorption field area including the slope?	Yes	No
8. Are there any other considerations that should be addressed that may cause the on-site sewage system installed in this fill area to fail prematurely; or if you answered any of the above comments by checking NO, please explain below:		
9. The soil type at the site is:		
10. The fill soil has an estimated percolation rate of:		
11. The size of the fill site is:		
12. The height of the fill area is:		
<b>The fill site is (circle one)</b>		
APPROVED	DISAPPROVED	
I certify that is information on this document is true.		
Signature of Certified Soil Classifier: _____		Date: _____
Print Name/Phone Number: _____		

Figure 35.H Falling Head Permeameter Permeability Chart

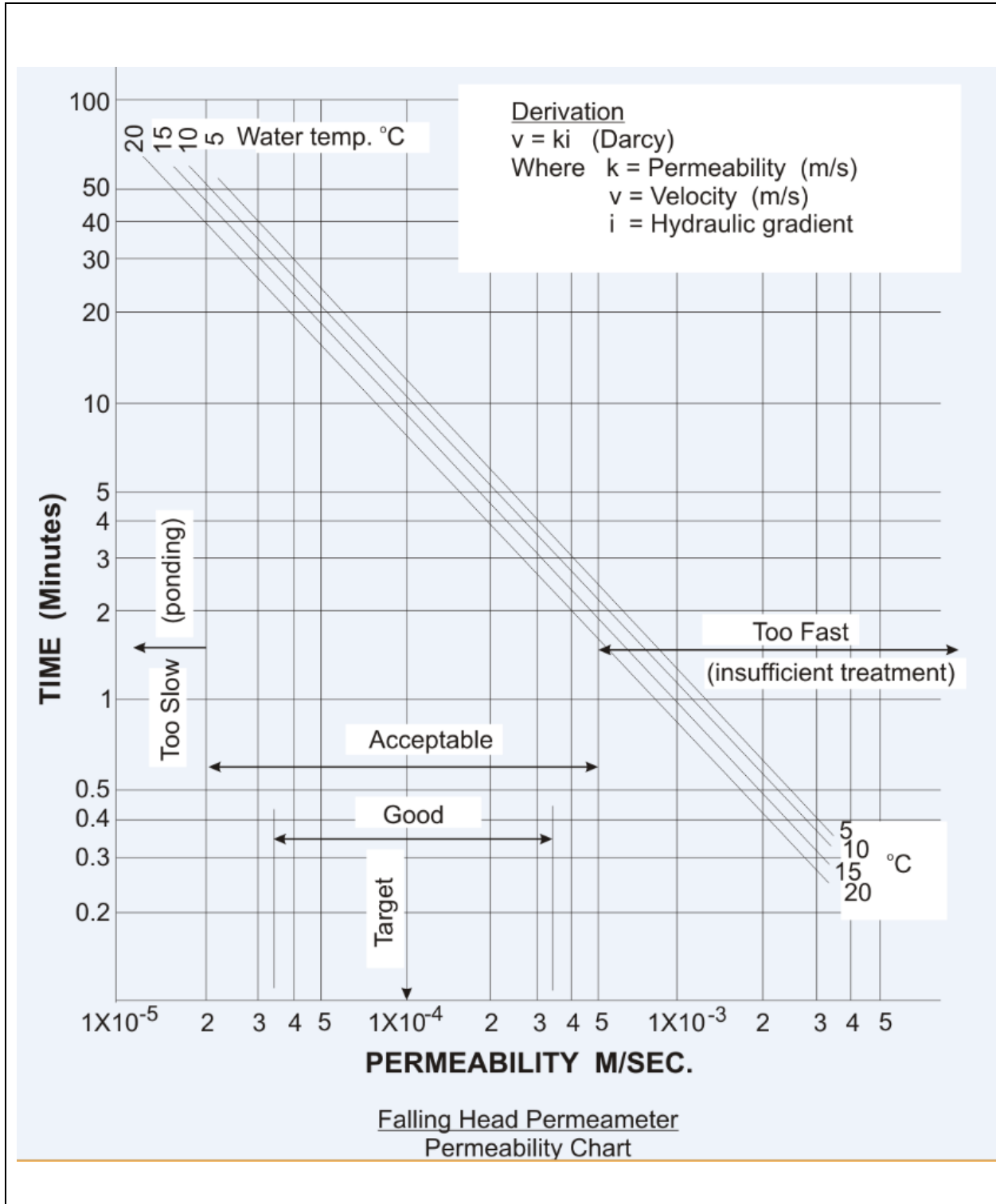



# Manual for On-Site Sewage Management Systems

SECTION I | SEPTAGE REMOVAL AND DISPOSAL

Environmental Health Section

**SECTION I – SEPTAGE REMOVAL AND DISPOSAL****1) Septage Removal Permits**

Permits shall be valid for a period of twelve months and shall be subject to being denied, suspended or revoked by the County Board of Health, unless the complete septage removal and disposal is carried out in accordance with Chapter 511-3-1 and the provisions outlined below.

**2) Standards for Septage Removal**

The following requirements shall be met by individuals certified for septage removal:

- A. The manner in which septage will be disposed of shall be included on the application for septage removal. Written authorization shall be submitted with the application from wastewater treatment plants, separate septage handling facilities or permitted land disposal site.
- B. The manner in which septage will be removed and transported shall be included on the application for septage removal.
- C. Access to the septic tank contents shall be by removal of the lids or access ports. Individuals breaking holes in the septic tank or lids will be subject to permit suspension or revocation.
- D. Septage removal means the complete removal of the contents including the liquid, sludge and scum.
- E. The inlet and outlet “tees” will be inspected for blockage and damage. If “tees” are missing or damaged, the owner will be notified in writing. Missing or damaged “tees should be replaced.
- F. Excavated soil will be replaced.
- G. Written documentation shall be provided to the septic tank owner noting the condition of the septic tank. This shall include any damage or missing components observed, and a copy will be provided to the Local Environmental Health Office.
- H. Individuals permitted for septage removal shall maintain a manifest identifying the date and location of system serviced and the date and location of final disposal.

**3) Septage Disposal**

There are three options for septage disposal in Georgia: treatment at a wastewater treatment plant, treatment at a separate septage handling facility and land disposal. Disposal and treatment at wastewater treatment plants, separate septage handling, and land application sites are regulated through Georgia Department of Natural Resources’ Environmental Protection Division.

**4) Temporary Storage of Septage**

The Department recognizes there may be instances when domestic septage must be temporarily stored until final disposal in the event disposal of septage is delayed by inclement weather; or

a local Department of Georgia Environmental Protection approved treatment facility is briefly inaccessible. The County Board of Health may allow under the authority of the septage removal permit a certified septage or portable sanitation pumper to provide for temporary septage storage at their company's base of operation by meeting the following criteria:

- A. Successful application and approval for on-site storage as reviewed by the local environmental health authority.
- B. Installation of below ground tanks must meet the standards and installation requirements of the Department for septic tanks and should be a state approved concrete, plastic or fiberglass tank.
- C. Above ground tanks should be placed on a curbed impervious pad made from materials to support the weight load and facilitate clean up in the case of a spill.
- D. Tanks should be designed for the stress of the holding capacity.
- E. Storage tank volume should be proportional to the scale of business of the pumping company. The maximum projected capacity must be no more than two to three days of typical pumping as demonstrated by manifesting.
- F. Temporary storage capacity must be for a single company use only, no multiple haulers comingling or "offloading" from other companies will be allowed. Manifesting must document transfer for truck to tank, etc. to disposal or handling facility.
- G. All local and state regulations and laws must be met, inclusive of approved zoning, business licensing, and County Environmental Health Removal and Disposal permitting and necessary inspection.

5) Tables, Figures and Forms

Form 12.I Waste Removal and Disposal Application and Permit



\_\_\_\_\_ County  
**Application for a Waste Removal  
 and Disposal Permit**

Application Date: \_\_\_\_\_  
 Company Name: \_\_\_\_\_ Company DPH Cert #: \_\_\_\_\_  
 Owner/Agent Name: \_\_\_\_\_ Email: \_\_\_\_\_  
 Company Street Address, City, State, Zip: \_\_\_\_\_  
 Primary Phone: \_\_\_\_\_ Alternate Phone: \_\_\_\_\_  
 List Employee Names and DPH Certification Number(s) Performing Pumping:

Circle All Applicable Selections:

Business Type:           Septage Pumper  
                                   Portable Sanitation Pumper  
 Onsite Storage:        Yes No  
 Final Disposal Facility Type:    Land Application Facility  
                                   Wastewater Treatment Facility  
                                   Wastewater Handling Facility  
 Disposal Facility or Land Application Site Name: \_\_\_\_\_  
 Describe business plan for pumping, storing, transferring and disposing:

Applicant Signature: \_\_\_\_\_  
*Waste Removal and Disposal Permit  
 to completed by County Environmental Health Department.*

Onsite Storage Inspected & Approved:	YES	NO
Manifest(s) Submitted and Approved:	YES	NO
Truck Inspection(s) Approved:	YES	NO
Disposal Facility Letter of Acceptance:	YES	NO
Application Approved:	YES	NO
Remarks:	_____	
	_____	
Issuing Inspector:	Inspector Signature:	
Permit Number:	* Permit Issue Date:	
* Permits expires at the end of the calendar year.		

**Form 13.I Waste Removal and Disposal Inspection Form**



\_\_\_\_\_ County  
**Waste Removal and Disposal Inspection Form**

Inspection Date: \_\_\_\_\_ County Permit #: \_\_\_\_\_  
 Company Name: \_\_\_\_\_ Company Phone: \_\_\_\_\_  
 Owner/Agent Name: \_\_\_\_\_ Company DPH Cert #: \_\_\_\_\_

Septage Pumper: Yes No Portable Sanitation Pumper: Yes No

VEHICLE DETAILS	Vehicle 1	Vehicle 2	Vehicle 3	Vehicle 4	Vehicle 5
Volume Capacity (gallons)					
DOT Number					
State Tag Number					
Manifest Submitted (Yes/No)					
VEHICLE IDENTIFICATION	All items must be displayed on both sides of each vehicle (YES/NO)				
Name of Person or Firm					
Permit Number					
2" Letters & Numbers					
Readily Visible					
VEHICLE MAINTENANCE	Verified with clean water or inspected during routine pumping (YES/NO)				
Watertight Tank & Body					
Leakage From Pumps					
Leakage From Hoses					
Leakage From Valves					
Leakage From Fittings					

PORTABLE SANITATION ONLY	Adequately sized tanks for # of units (route) served (YES/NO or N/A)				
Waste Tank					
Sanitizing Solution Tank					
To be completed if servicing hand washing fixtures					
Potable Water Source					
Fresh Water Tank					
Labeled "Do Not Drink"					
Potable Water Hose Labeled					

Inspected By: \_\_\_\_\_ Inspector Signature: \_\_\_\_\_  
 Remarks: \_\_\_\_\_  
 \_\_\_\_\_  
 \_\_\_\_\_  
 \_\_\_\_\_  
 \_\_\_\_\_

Inspection Approved: Yes No Permit Issue Date: \_\_\_\_\_  
 Permit Expiration Date: \_\_\_\_\_



GEORGIA DEPARTMENT OF PUBLIC HEALTH

# Manual for On-Site Sewage Management Systems

SECTION J | SEWAGE FLOW SCHEDULE

Environmental Health Section

## SECTION J – SEWAGE FLOW SCHEDULE

Table 13.J Sewage Flow Schedule

Facility Type	Gallons Per Day (GDP)
Airport (Also R.R. & Bus Terminal) No Food Service	5/Passenger +10/Employee
Assembly Hall (Also Stadium, Racetrack)	5/Seat
Bar/Lounge (No Food Service)	30/Seat
Barber Shop	100/Chair +20/Employee
Bath House for Swimming Pool	10/Swimmer
Bath House for Travel Trailer Park, Campground <sup>3</sup> With Independent Sewer Connections	50/Space
Without Independent Sewer Connections	100/Space
Beauty Salon	150/Chair + 20/Employee
Boarding House <sup>3</sup>	75/Resident
Bowling Alley (No Food Service)	75/Lane +20/Employee
Car Wash (Non-Recycling, with EPD Approval)	75/Car
Church (No Kitchen)	5/Sanctuary Seat
Church (With Kitchen)	7/Sanctuary Seat
Construction Camp <sup>3</sup>	60/Person
Construction Camp With Use of Chemical Toilets	40/Person
Cottage/Lodge (Vacation)	50/Bed
Country Club (No Food Service)	25/Member
Dance Hall (No Food Service)	5/Person
Day Camp	20/Person
Day Care Center <sup>3</sup> (No Meals)	15/Person
Day Care Center <sup>3</sup> (With Meals)	20/Person
Dental Office (Continuous Water)	250/Chair + 20/Employee
Dental Office (Demand Water)	100/Chair + 20/Employee
Dump Station for Travel Trailers	50/Vehicle
Fairground (Use Average Attendance)	5/Person
Fitness Center/Spa	50/Person
Food Service <sup>1,3</sup>	
Restaurants, less than 24 hrs/day	50/Seat
Restaurants, 24 hrs.	75/Seat
Restaurants on Interstates	100/Seat
Drive-In Restaurant	50/Space
Carryout Only; Food Stands	50/100ft <sup>2</sup> Floor Space +20/Employee
Banquet Rooms	Add 5/Seat
Single-Service Only	Subtract 10/Seat
Catering (Single Service Only)	50/100ft <sup>2</sup> Floor Space
Catering (Full Service) + 5/Meal	+ 5/Meal
Funeral Home Sanctuary Seat (no kitchen)	300/Embaling Table + 100/Staff Member +5/seat
Funeral Home Sanctuary Seat (with kitchen)	300/Embaling Table + 100/Staff Member +7/seat

Grocery Store <sup>1</sup>	200/1000ft <sup>2</sup> Floor Space
Hospital	300/bed +100/Resident Staff
Hotel/Motel <sup>3</sup> No Kitchenette	100/Room
Hotel/Motel <sup>3</sup> with Kitchenette	150/Room
Institution <sup>1</sup>	100/Bed
Laundry, Self-service (with EPD Approval)	500/Machine
Marina (pump out facilities)	30/Slip
Meat Market <sup>1</sup>	50/100ft <sup>2</sup> Floor Space
Medical Offices	200/Exam Room
Migrant Labor Camp <sup>3</sup>	50/Bed
Nursing Home/Personal Care Home <sup>1</sup>	150/Bed +100/Resident Staff
Picnic Park	10/Person
Prison/Jail <sup>1</sup>	125/Bed +20/Employee
Resident Camps <sup>3</sup> (With Food Service)	60/Person
Resident Camps <sup>3</sup> (Without Food Service)	50/Person
Residential (for alternative systems) <sup>4</sup>	150/Bedroom
Resort <sup>3</sup>	75/Person
Rest Area	Requires consultation w/GaDOT
Retail Stores, Convenience Stores <sup>1</sup> (Freestanding)	Larger of 400/Restroom or 100/Commode or Urinal
Rooming House <sup>3</sup> (No Meals)	60/Bed
Schools: Day, Toilets Only	12/Person
Schools: Day, Toilets & Cafeteria <sup>1</sup>	16/Person
Schools: Day, Toilets, Cafeteria, Gym <sup>1</sup>	20/Person
Schools: Boarding	100/Person
Service Station: Interstate Location	3000 Minimum
Service Station: 24 Hour Operation	325/Commode or Urinal
Service Station: <24 Hour Operation	250/Commode or Urinal
Shopping Center/Mall	100/1000ft <sup>2</sup> Enclosed Space
Theaters (Indoor)	5/Seat
Theaters (Drive-In)	10/Space
Travel Trailer Park <sup>2</sup> With Independent Water & Sewage Connections	150/Space
Veterinary Office/Animal Hospital <sup>3</sup>	100/Run +10/Cage +20/Employee
Workers Including Factory, Office, School, Commercial and Construction	
Without Showers and Industrial Waste	25/Person
With Showers and No Industrial Waste	35/Person
With Kitchen	+5/Person
<sup>1</sup> Operations w/BOD <sub>5</sub> and TSS > 200 mg/l require pretreatment to reduce BOD <sub>5</sub> and TSS to 200 mg/l or below. <sup>2</sup> Means the temporary rental of sites. Add 500 gallons/machine if washing machine installed. Parks established for the permanent placement of RV's shall meet the same requirements established for single-family residential use. <sup>3</sup> Add 500 gallons/machine if washing machine installed. <sup>4</sup> For residential properties using conventional systems, refer to Section D. <sup>5</sup> The minimum septic tank capacity shall be 1000 gallons for one, two, three or four bedrooms and 250 additional gallons for each bedroom over four.	

**Sewage Flow Schedule Notes:**

1. Facilities with multiple uses require additive flows, e.g. a grocery store with a food service would utilize 200/1000ft<sup>2</sup> of floor space plus 50/seat.
2. Applicants may submit water usage data for identical or similar operations where uses are not noted in Table 13.J or where the applicant is requesting design based on a lesser flow than determined from Table 13.J. The Health Department may consider such data as one component in determining peak flow and shall not allow designs based on averages.

**Table 14.J Design Basis for Central Septic Tank Systems**

<b>Central Septic Tank System</b>	<b>Minimum Septic Tank Capacity</b>	<b>Minimum Absorption Field Area (Based on Bedrooms)</b>
Mobile Home Park	1000 gallons / space <sup>5</sup>	3 Bedroom minimum / space
Multi-family residential	1000 gallons / unit <sup>5</sup>	Based on # of Bedrooms



# Manual for On-Site Sewage Management Systems

## SECTION K | FIELD INSPECTIONS

Environmental Health Section

## SECTION K – FIELD INSPECTIONS

### 1) Preface

All on-site sewage management systems must be inspected before they are put into operation. This section gives details on what to look for and how to properly inspect the various parts of a system.

### 2) Request for Inspection

All of the following information must be provided to the County Environmental Health Office when requesting a field inspection:

- A. Name and phone number of contractor/installer
- B. Property owner name
- C. Location of property
- D. Installation permit number
- E. Directions to property
- F. Time system will be ready for inspection

It is very important that the contractor/installer has a copy of the installation permit on site. If a copy cannot be made available in a timely fashion, the inspection must be discontinued and rescheduled.

### 3) Inspection of Septic Tanks

All installed septic tanks must be inspected carefully to verify that they have been installed in accordance with the permit and the specifications required in the regulations and this Manual. The list below represents important points to check during an inspection:

- A. The septic tank must be located as marked on the plan. If the tank has been installed at another location, the new location must be approved. The tank must not be installed where it would violate setback requirements.
- B. A septic tank must not be installed where it could be flooded, unless it has been designed and installed to remain watertight.
- C. The tank must remain visible for inspection prior to backfilling.
- D. All septic tanks must be level, side to side and inlet end to outlet end. The inlet and outlet must be located in the right directions so that the effluent will flow to the treatment and disposal field.
- E. Septic tank walls must not be cracked, have honeycombs or show other defects that may cause the tank to weaken or leak. Reinforcing steel must be covered with at least 1-inch of concrete to keep it from corroding and must not be visible.
- F. The baffle wall must be located between two thirds and three-fourths of the tank length from the inlet end and must have a four-inch diameter opening at least the size of the inlet

to allow the effluent to flow to the outlet. The top of the baffle wall must leave a two-inch slot for gas passage. Waste concrete may be in this slot--simply break it out to open up the two-inch slot.

- G. The sanitary tee must be undamaged and extend into the liquid one-fourth of its depth. The tank outlet must be two inches below the inlet.
- H. All joints in the tank must be sealed and watertight. Joints must be sealed with a nominal one-inch diameter bead of mastic or other approved sealer along its joints.
- I. A septic tank riser over each access opening is required if the top of the tank is more than 12 inches in the ground. The riser is required to extend to finished grade or to no deeper than 12 inches below finished grade. For easy access, pump tanks should have a riser over the pump access opening and the riser should extend to finished grade.
- J. Tank risers must be large enough to allow easy access to the tank access openings and must have a strong lid.
- K. Pipes must enter and exit the tank through the knockouts provided. The outlet pipe from the tank must be sealed to be sure that it will not leak.
- L. Where not inspected by a building or plumbing inspector, the inlet pipe from the house must have a minimum slope of 1/8 inch per foot so the sewage will flow to the septic tank. This pipe must be sealed on the inside and outside of the tank to prevent groundwater from leaking into the septic tank or effluent from escaping into groundwater.

#### **4) Inspection of Conveyance Piping**

The conveyance piping must be inspected to be sure that there are no leaks and that the pipe (s) will not block the flow of the effluent to the distribution device or the treatment and disposal trenches. A separation of at least two feet of undisturbed or compacted soil is needed between the septic tank and the distribution device or trench. This separation reduces the problem of effluent leaking back around the pipe to the septic tank. Conveyance pipes must be solid, non-perforated NSF/ANSI schedule 40 PVC.

- A. The pipes must be installed in trenches with bottoms of undisturbed or compacted soil so the soil will not settle and break the pipe.
- B. All conveyance pipes must have an adequate slope to allow the sewage to flow by gravity to the distribution device or trench. The slope of the pipe can be determined by measuring the height of the pipe at the septic tank outlet and at the distribution device or trench inlet and the length of the pipe. The slope is the height divided by length.
- C. The conveyance pipes must be installed to meet all required setback distances.
- D. All the joints in the conveyance pipe, its connections to the septic tank and the distribution device or trench must be watertight.

#### **5) Inspection of Distribution Devices**

Distribution devices include distribution boxes, flow splitters and other flow diversion devices. All of these devices must be inspected for proper installation and so that the effluent will flow equally to all the trenches.

- A. Be certain that the distribution box, flow splitter or other flow diversion device is installed at the proper location and as marked on the plans. Check that the location meets all setback distances.
- B. All distribution devices must be installed on firm earthen foundation secured by concrete or concrete foundation to prevent the soil from settling. If the soil settles, the device can tilt so that the effluent is not evenly distributed and possibly leak from the device. A good test is to stand on the box and try to rock it. It must not rock or tilt.
- C. Test all distribution devices, especially distribution boxes, to be sure that the outlets are at the same level. The testing must be done by pouring water into the distribution box in its installed location and watching for the water to flow out of the outlets at the same time and with the same flow from each outlet. Measuring with a builder's level or another instrument is not accurate for this purpose. This means the contractor must have water on site.
- D. Check the connections of the conveyance pipes to the distribution device to make sure there are no leaks.
- E. Inspect distribution boxes to be sure that they are watertight and sturdy.
- F. One way to check for a leaking distribution box is to check the water level early in the inspection and then at the end of the inspection. If the water level has dropped below the outlet, there is a leak in the box.
- G. Be sure that the distribution box inlet is two inches higher than the outlet so the effluent will flow out to the treatment and disposal trenches. Distribution boxes may be installed backwards, so it is important to check the orientation.
- H. For gravity systems, make certain the distribution box outlets are at least six inches below the septic tank outlet so the full trench depth can be used without directing effluent back into the septic tank (four-inch tank to box and two- inch box to perforated distribution pipe).

## 6) Inspection of Trenches

Absorption trenches are where most of the bacterial treatment takes place in on-site sewage disposal. Proper installation of trenches is critical to the overall performance of the system.

- A. The trenches must be installed on the contour so that the entire trench is at the same level.
- B. The absorption field must be located in the proper place on the site and at the place marked on the plan. If the field has been relocated, check that all setback requirements have been met. It is very important that the relocated absorption field NOT be placed in an area where the soil is unsuitable.
- C. The absorption field must not be placed under driveways, roads or buildings. The heavy compaction of the soil under a driveway, road or building could keep the effluent from flowing into the soil.
- D. The number of trenches, the length of each trench and the total area of the trench bottom must be as shown on the permit.
- E. The width and depth of the trenches must be as shown on the permit.

- F. Trenches must be spaced properly, which means that the trenches must be spaced at least seven feet on center and there will be at least four feet of undisturbed soil between the edges of the trenches.
- G. Trenches cannot be more than 36 inches wide.
- H. Corrugated pipes used in the trenches must be stamped ASTM F667 approved, must be located in the center of the trench and be covered with aggregate. The pipe must be four inches corrugated polyethylene (PE) tubing with three ½ -inch to ¾-inch holes around the pipe every four inches along the pipe length. The holes must be oriented toward the bottom of the trench as much as possible.
- I. The aggregate or gravel in the trench must be hard and resist crumbling when wet with the effluent. Only washed stones must be used so that the fines have been removed. Fines can plug the soil or fill in the spaces between the crushed stone.
- J. There must be six inches of aggregate under the pipe, and the aggregate must surround the pipe on all sides, with 2 inches of aggregate covering the pipe. Acceptable sizes are one half (1/2) inch to two (2) inches in diameter. To avoid grinding the stone together and making more fines, aggregate must not be driven over with equipment. The stone is not to be mixed with the soil at the bottom of the stockpile. Placing a piece of plywood or sheet plastic under the stockpile can reduce the amount of soil that mixes in with the stone.
- K. Use of other aggregate must comply with paragraphs I and J above as appropriate.
- L. Trenches shall not be dug when soil is wet due to the potential for smearing and compaction. If the soil can be rolled into a wire, it is too wet.

## 7) Inspection of a Subsurface Emitter System

The following is a brief checklist of actions and technical areas that must be addressed during on-site inspection of a subsurface emitter system. This will require both initial and final on-site inspections. The final on-site inspection must be performed after all landscaping and dwelling construction are completed.

### A. *Initial On-site Inspection Check List*

1. *System is installed according to permit and site plan*
  - a. Treatment units used
    - (1) Aerobic/aeration unit, or
    - (2) Other approved treatment unit
  - b. Dosing system
    - (1) Tank size as designed
    - (2) Dosing pump (designed for wastewater effluent)
    - (3) Record pump make and model number as specified
    - (4) Ready access provided for maintenance
    - (5) All separation distances are correct

2. *Make a field drawing/sketch of system layout*
  - a. Emitter field properly sited
  - b. Emitter lines have appropriate amount of footage NOTE: Use of a measuring wheel or tape measure required.
  - c. Emitter trenches at proper depth
3. *System Operational Demonstration*
  - a. Field Dosing by timing device
  - b. Emitters designed for wastewater
  - c. Emitters function properly
  - d. Pressure relief valves present
  - e. Check valves present
  - f. Return lines properly routed to treatment unit
  - g. Filter back flushes properly
  - h. Filter readily accessible for maintenance
  - i. Safety provisions are adequate
    - (1) Tamper proof lids on risers, etc.
    - (2) Electrical component connections inspected by appropriate authority.
      - All connector boxes sealed
      - All wiring routed through conduit pipe
      - Electric components connected to power source
  - j. Air compressors function
  - k. Air compressor alarms function
  - l. Pumps function
  - m. High water alarm functions
  - n. Drainfield piping contains a zone splitter valve
  - o. Name and phone number of maintenance point of contact posted beside visual alarm

B. *Final Onsite Inspection Checklist*

1. *Landscaping*
  - a. Appropriate groundcover
  - b. Surface water drainage appropriate
2. *Documentation*
  - a. Owner provided copy of maintenance contract and warranty provisions

- b. Owner provided copy of inspection documentation

**8) Inspection of Wisconsin Mound Systems**

- A. See Section F.
- B. See Section O – Appendix 3 and 4 for Inspecting and Troubleshooting Wisconsin Mounds.



# Manual for On-Site Sewage Management Systems

SECTION L | OPERATION AND MAINTENANCE

Environmental Health Section

## SECTION L – OPERATION AND MAINTENANCE

### 1) Operation

Benefits of proper design and installation of on-site sewage management systems can be completely overshadowed by improper operation, maintenance and/or repair activities. Inadequate maintenance is the primary reason for most on-site sewage management system malfunctions. Problems which can develop even in a properly designed and installed system include:

- A. Excessive amounts of water, grease or non-biodegradable materials entering the wastewater system and resulting in backups to homes or flooding of the drainfield;
- B. Uneven wastewater distribution;
- C. Seepage from the disposal area and surface seepage resulting in pollution of ground or surface waters.

### 2) Maintenance

The most common on-site maintenance procedure is pumping out septic tanks. As sludge accumulates in a septic tank, the capacity of the tank to hold and treat incoming wastewater decreases and the quantity of solids leaving the septic tank increases. These solids can clog the soil at the disposal field (drainfield) and unnecessarily pollute the groundwater or a nearby stream or lake. Pumping out septic tanks periodically helps to avoid such problems. The septage, which is pumped out from a tank, must be properly disposed of either at a treatment plant or at an approved land disposal site.

Chemical or biological additives are not a substitute for pumping. In general, these products, which claim to “clean” septic tanks, contain biological based materials (bacteria, enzymes and yeast), inorganic chemicals (acids and bases) or organic chemicals (including solvents) that may result in sludge bulking and interfere with digestion. The resulting effluent may severely damage the soil structure and cause accelerated clogging, even though some temporary relief may be experienced immediately after application of the product.

It is not necessary to add anything but domestic wastewater to the septic tank. Materials that degrade slowly or do not settle well should not be put into septic tanks. Coffee grounds, cooking fats, cigarette butts, bones, wet strength towels, disposable diapers, condoms, feminine hygiene products and similar materials must be disposed of in another manner. They will not degrade in the tank and can clog inlets, outlets and the disposal system.

The recommended minimum frequency for pumping out septic tanks depends upon the size of the tank, flow of wastewater entering the tanks and the solids content of the wastewater. By assuming a minimum wastewater residence time within a tank and assuming a certain percentage of the retained solids are decomposed, minimum pump out frequencies can be estimated. Table 15.L lists estimated pump out frequencies assuming wastewater residence time of 24 hours and assuming 50 percent of the solids are decomposed or digested.

Lack of any inspection and maintenance allows structural deficiencies to go unnoticed and possibly jeopardizes the absorption system. In septic tanks and pumping chambers, bad seals

and cracks which go uncorrected may allow significant amounts of groundwater or surface water to infiltrate and overload the system. Baffles which are no longer functional or in their proper location may be permitting significant amounts of undetected solids to pass into the absorption area.

Septic tank designs can be modified to produce an inlet and outlet device, which will be efficient and long lasting in a highly corrosive environment. Inspections made during the repair process often find baffles or concrete tees which have deteriorated and fallen off on the bottom of the tank, thereby allowing solids to flow into the soil absorption area, possibly clogging the soil. Inspection ports on septic tanks extended to the ground surface can help facilitate maintenance checks. Incorporation of ports or access openings would serve to continuously remind the users of the location of the facilities and allow ready access for maintenance.

### **3) Performance Evaluation of Existing On-site Sewage Management Systems**

The County Board of Health is routinely asked to conduct performance evaluations of existing on-site sewage management systems. Such evaluations shall be based on available data relating to the system including:

- Inspection records of initial system installation;
- Maintenance records of the on-site sewage management system;
- Site evaluations to determine the current performance of the on-site sewage management system.

Representatives of the County Board of Health will verify the status of the system at the time of the evaluation, based on the availability of the above data using the Existing On-site Sewage Management System Performance Evaluation Report Form.

The Health Department representatives conducting the evaluation should document their findings by completing only one section of the evaluation report form when using Section A, B, or C using criteria detailed below. Section D should be completed in conjunction with either Section A, B, or C.

## 4) Tables, Figures and Forms

**Table 15.L Est. Septic Tank Pumping Frequencies (in Yrs) for Year-Round Residences**

Tank Size (gallons)	Household Size (number of people)									
	1	2	3	4	5	6	7	8	9	10
1000	12.0	5.9	3.7	2.6	2.0	1.5	1.2	1.0	0.8	0.7
1250	16.0	7.5	4.8	3.4	2.6	2.0	1.7	1.4	1.2	1.0
1500	19.0	9.1	5.9	4.2	3.3	2.6	2.1	1.8	1.5	1.3
1750	22.0	11.0	6.9	5.0	3.9	3.1	2.6	2.2	1.9	1.6
2000	25.0	12.0	8.0	5.9	4.5	3.7	3.1	2.6	2.2	2.0
2250	29.0	14.0	9.1	6.7	5.2	4.2	3.5	3.0	2.6	2.3
2500	32.0	16.0	10.0	7.5	5.9	4.8	4.0	4.0	3.0	2.6

*Note: The frequencies estimated are based on a minimum 24-hour wastewater retention time and 50 percent digestion of the solids entering the tank. More frequent pumping would be needed if garbage disposals were utilized.*

(Source: Mancl, Karen)

## Form 14.L Existing On-site Sewage Management System Performance Evaluation Report



### Georgia Department of Public Health On-Site Sewage Management System Performance Evaluation Report Form

APPLICANT NAME:	PROPERTY/SYSTEM ADDRESS:	EVALUATION ID:
APPLICANT PHONE:		COUNTY:
APPLICANT EMAIL ADDRESS:	SUBDIVISION/LOT:	REASON FOR EVALUATION:
<b>Inspection Records</b>		
	1. Inspection records exist for this septic system.	
	2. Inspection records indicate that all components of the septic system were properly constructed and approved at the time of original inspection. A copy of the original inspection report is attached.	
<b>Maintenance Records (applicable copies are attached)</b>		
	3. Maintenance or installation records indicate that the tank has been pumped out or installed within the past 5 years. Note: it is recommended that septic tanks be pumped at least once every 5 years.	
	4. Systems with aerobic treatment unit(s) (ATU): Records indicate the ATU has been serviced in accordance with the manufacturer's recommended maintenance schedule OR an authorized representative of the manufacturer has provided documentation that the ATU is operating sufficiently.	
	5. Systems with a grease trap(s): Maintenance records indicate the grease trap(s) has been pumped out within the last 6 months OR documentation has been provided by a qualified individual confirming that the grease trap contains less than 75% of the designed grease holding capacity and is operating sufficiently.	
<b>System Assessment and Existing Site Conditions (applicable copies are attached)</b>		
	6. The septic tank was uncovered at the time of this County Board of Health Evaluation OR maintenance records exist and the tank appears to meet the required design, construction, and installation criteria. The appropriateness of the sizing and installation criteria of the system cannot be verified since no initial inspection records exist.	
	7. A Georgia certified septic tank installer has provided written documentation of the system design, location, and components.	
	8. This site evaluation by the County Board of Health revealed no evidence of system failure.	
	9. This site evaluation by the County Board of Health revealed no evidence of adverse conditions which would affect the functioning of the system.	
<b>Addition to Property</b>		
	10. This site evaluation as well as the provided information indicate that the proposed construction to the home or property should not adversely affect the functioning of the existing system.	
<b>Relocation of Home or Change of Use</b>		
	11. This site evaluation as well as the provided information indicate that the system appears to meet the required design, construction, and installation criteria to accommodate the proposed relocation of the home or change of use for the facility should not adversely affect the functioning of the existing system.	

See 2nd page for evaluation notes, disclaimer, and signature.

## Performance Evaluation Report Form (continued)

PROPERTY/SYSTEM ADDRESS:	EVALUATION ID:
	SUBDIVISION/LOT:

**Adverse Conditions** (i.e. malfunctioning or damaged system or clear evidence of a condition, or conditions, that would likely contribute to system malfunction or unacceptable risk to public health):

**Additional Notes/Comments:**

**Inspector:**

**Signature:**

**Date:**

I verify the above information to be correct at the date and time of this evaluation only. Disclaimer: This verification shall not be construed as a guarantee of the proper functioning of this system for any given period of time. No liability is assumed for future damages that may be caused by system malfunction.

## Existing OSSMS Performance Evaluation Report Form Instructions

<b>Existing Onsite Sewage Management System Evaluation Report Instructions Internal Document for Training Purposes</b>
<b>Inspection Records</b>
<ul style="list-style-type: none"> <li>• If inspection records do not exist, choose "N/A" for # 2.</li> <li>• If records indicate the system was NOT properly constructed/approved, chose "No" for # 2 and provide documentation and detailed remarks.</li> </ul>
<b>Maintenance Records</b>
<ul style="list-style-type: none"> <li>• If there are no records OR if the records indicate it has been more than 5 years since maintenance, choose "No" for # 3. "N/A" is not an option for #3.</li> <li>• If there is not an ATU or grease trap, choose "N/A" for # 4-5.</li> <li>• If any of the Items are answered "No", details and recommendations should be added in the notes and/or adverse conditions section.</li> <li>• Documentation is required for any "yes" answers.</li> <li>• For loan letters, etc. comment in adverse condition that there is no documentation of maintenance.</li> </ul>
<b>System Assessment and Existing Site Conditions</b>
<ul style="list-style-type: none"> <li>• Items 6 and 7 can be used if no inspection records exist. <ul style="list-style-type: none"> <li>◦ Select NO if you request it and they refuse to do it. If it's not needed or requested, select N/A.</li> </ul> </li> <li>• Use the comments section to detail any conditions which might affect the evaluation (ex. The home was unoccupied for more than 30 days prior to the evaluation; the yard was overgrown with weeds making visual inspection of the absorption field difficult, etc.).</li> <li>• If any of the Items are answered "no", details should be in the <u>comments</u> notes.</li> </ul>
<b>Addition to Property/ Relocation of Home or Change of Use</b>
<p>The health department representative should complete this section in cases where another local, municipal, or state agency requires the local board of health's review prior to additions to the home or property, a change of use, or a relocation of a home/mobile home.</p> <ul style="list-style-type: none"> <li>• An evaluation of maintenance records is not necessary for building additions (ex. office, sunroom, porch, out buildings, swimming pool, etc.).</li> <li>• The approximate sewage flow that the existing system should be able to dispose of is to be indicated by the number of bedrooms or gallons per day in the comments section.</li> <li>• Any proposed increased sewage flows should be permitted by the health authority as an addition to the existing system.</li> <li>• The septic tank size should be appropriate for a garbage grinder if indicated. If the existing tank size cannot support a garbage grinder, a new, appropriately sized tank should be permitted by the local health authority.</li> <li>• Add in comments any additional sizing requirements to change to use, added bedrooms, etc.</li> </ul>
<b>Adverse Conditions</b>
<p>The term "adverse conditions" means the direct observation of a malfunctioning or damaged system or clear evidence of a condition, or conditions, that would likely contribute to system malfunction or failure. The following are examples of "adverse conditions":</p> <ol style="list-style-type: none"> <li>1. Documentation that a system was not approved at the time of inspection.</li> <li>2. Failure to provide proof that a pumping or maintenance schedule has been followed or failure to document that a an ATU is in a satisfactory operating condition.</li> <li>3. Evidence of a system failure or malfunction (ex. surface discharge, insufficient treatment, sewage backup in the house).</li> <li>4. Evidence of system damage that would be detrimental to the functioning of the system.</li> <li>5. Driveway, building, or immobile structure placed on top of any component of the system.</li> <li>6. Improperly sized septic tank or drainfield.</li> </ol>



# Manual for On-Site Sewage Management Systems

SECTION M | RECOMMENDED LOT SIZING CRITERIA

Environmental Health Section

## SECTION M – RECOMMENDED LOT SIZING CRITERIA

To provide for the orderly and safe development of property utilizing on-site sewage management systems, the following criteria for establishing minimum lot sizes are recommended for use by County Boards of Health, which are authorized by Georgia statute in OCGA 31-3-5 (b) (2) to establish minimum lot sizes. Larger lot sizes may be required to meet the requirements of this Manual depending on the proposed development of the property. County Boards of Health and/or County Zoning Authorities may require larger minimum lot sizes; such establishment of larger minimum lot sizes will take precedence.

### 1) Lot size requirements

Lot size requirements are as follows for single family dwellings including but not limited to: manufactured or mobile homes, stick built homes, modular homes, etc., and individual lots in subdivisions or mobile home lots located in areas other than commercial mobile home parks. Area requirements for multiple dwellings on a single recorded lot, where not prohibited by local zoning, must be provided in multiples of the following minimum lot sizes for each dwelling to be constructed on the recorded lot. See Table 16.M and subparagraphs 1A through 1F as follows:

**Table 16.M MT-1 Minimum Lot Sizes – Single Family Dwellings**

Type of Water Supply System	Non-Public* (Individual)	Public
Minimum Lot Size	43,560 square feet	21,780 square feet
Minimum Lot Width	150 ft.	100 ft.
Maximum Sewage Flow	600 gpad**	1200 gpad**
* In this context "Non-public" means an individual water supply system or any other water supply system, which is not a "public" water supply system.		
**gpad = gallons per acre per day=gal/acre/day.		

- A. The above minimum lot sizes are for the typical size home (3 or 4 Bedroom) with basic appurtenances such as: driveway, minimum number of trees, and water supply line. If larger homes, swimming pools, tennis courts or outbuildings, etc. are proposed to be constructed or if trees would interfere with installation of an on-site sewage management system, the County Board of Health will require larger lots to assure useable soil area.
- B. The County Board of Health may also require larger lot sizes when physical factors indicate the need to do so. These factors include, but are not limited to, the availability of sufficient unobstructed land areas for an approved on-site sewage management system and approved replacement system, slope greater than 5%, percolation rates higher than 45 minutes per inch, need for subsurface drainage or adverse topographic features.
- C. Lots shall be a minimum width of one hundred feet (100') or one hundred fifty feet (150') measured within the area where an approved on-site sewage management system and replacement system are to be located when served by a public water supply system or non-public water supply system, respectively.

- D. The following land areas are not considered as a part of a lot when calculating the required minimum lot size: right of ways of roads, easements (such as power line or pipe line) that exclude installation of an on-site sewage management system, soil conditions that exclude the installation of an on-site sewage management system, bodies of water, land within 50 feet of a lake, river, stream, wetland or other bodies of water and similar limiting factors.
- E. There must be an unobstructed area on each lot for installation of an approved on-site sewage management system and an area equal in size for a conventional system or larger area, as appropriate, for an approved replacement system; this will include sufficient area for necessary site modifications for installation of both the initial system and a replacement system. All pertinent County zoning setbacks and other space requirements must also be met.
- F. The maximum daily sewage flow for each lot or parcel of land shall not exceed 600 gpad when served by nonpublic or individual water supply system or 1200 gpad when served by public water supply system. When sewage flows exceed these quantities (600 or 1200 gpad as indicated) for a given dwelling structure, the minimum lot size or parcel of land shall be increased proportionally.

**Example 1:** Assume a public water supply exists (so 1200 gpad maximum sewage flow allowed per minimum required land area of 43,560 square feet), and there is a proposed sewage flow of 5,000 gpd. To determine  $x$  = the square footage of the lot needed, use the following formula:

$$\begin{aligned} x &= \frac{5,000 \text{ gal/day}}{1,200 \frac{\text{gal}}{\text{acre}}/\text{day}} \\ &= 4.17 \text{ acres} \\ &= 4.17 \text{ acres} \times 43,560 \text{ ft}^2/\text{acre} \\ &= 181,500 \text{ ft}^2 \text{ area of land needed} \end{aligned}$$

**Example 2:** Likewise, for a non-public (individual) water supply, to determine  $Y$  = the square footage of the lot needed for a proposed sewage flow of 5000 gpd, use the following formula:

$$\begin{aligned} Y &= \frac{5,000 \text{ gal/day}}{600 \frac{\text{gal}}{\text{acre}}/\text{day}} \\ &= 8.33 \text{ acres} \\ &= 8.33 \text{ acres} \times 43,560 \text{ ft}^2/\text{acre} \\ &= 363,000 \text{ ft}^2 \text{ area of land needed} \end{aligned}$$

## 2) Lot Sizing Non-Single Family Dwellings

Lot sizing requirements are as follows for multi-family residential dwellings, all other non-single family dwellings and commercial structures, and this also includes mobile homes located in commercial mobile home parks. Paragraphs 1A through 1F above also apply to Table 17.M.

**Table 17.M MT-2 Minimum Lot Sizes – Non-Single Family Dwellings**

Type of Water Supply System	Non-Public* (Individual)	Public
Minimum Lot Size	43,560 square feet	21,780 square feet
Minimum Lot Width	150 ft.	100 ft.
Maximum Sewage Flow	600 gpad**	1200 gpad**
* In this context "Non-public" means an individual water supply system or any other water supply system, which is not a "public" water supply system. **gpad = gallons per acre per day=gal/acre/day.		

### 3) Criteria for Protection of Groundwater Recharge Areas

Rules of the Department of Natural Resources, Environmental Protection Division, Chapter 391-3-16-.02 require the following minimum lot sizes in the state of Georgia Groundwater Recharge Areas as defined by the above.

1. Subdivisions and Individual Lots: New homes served by septic tank and absorption field systems shall be on lots having the following minimum size limitations as identified in Table 16.M.
  - A. 150 % of the subdivision minimum lot size of Table 16.M if lot is within a high pollution susceptibility area;
  - B. 125 % of the subdivision minimum lot size of Table 16.M if lot is within a medium pollution susceptibility area;
  - C. 110 % of the subdivision minimum lot size of Table 16.M if lot is within a low susceptibility area.
2. Mobile Home Parks: New mobile home parks served by septic tanks and absorption field systems shall be on lots having the following size limitations as identified in Table 17.M.
  - A. 150 % of the subdivision minimum lot size of Table 17.M if lot is within a high pollution susceptibility area;
  - B. 125 % of the subdivision minimum lot size of Table 17.M if lot is within a medium pollution susceptibility area;
  - C. 110 % of the subdivision minimum lot size of Table 17.M if lot is within a low pollution susceptibility area.
3. If a local government requires a larger lot size than that required by (2A) above for homes or (2B) above for mobile homes, the larger lot size shall be used.
4. Local governments at their option may exempt from the requirements any lot of record prior to the date of adoption of the Rules of the Georgia Department of Natural Resources, Environmental Protection Division, Chapter 391-3-16-.02.

### 4) Tables, Figures and Forms

**Form 15.M Subdivision Analysis Record**

I. GENERAL INFORMATION		
Name of Subdivision:		
Owner/Agent:		Phone:
Address:		
Location of Subdivision:		
County:	Land Lot:	Land District:
Total Area of Subdivision (in acres):		Typical Lot Size (in square feet):
Number of Lots:		Typical Home Size (in square feet):
Typical Number of Bedrooms:		Typical Number of Bathrooms:
Adjacent Subdivisions		
Name of Subdivision	Location	Distance
II. SEWAGE DISPOSAL		
A. Public Sewage System Availability (existing or under construction)		
Name of System:		
Owner Name:		
Owner Address:		
B. Nearest Sewer to Subdivision or Overall Tract if Developed in Sections		
Distance:	Size:	Is gravity flow possible?
If system is under construction, give completion date:		
Future availability of sewer (planned or under construction):		
Are sewers to be extended to serve this area?		
Has the EPD approved plans and specifications? If so, provide approval date:		
Estimated date sewer will be available:		
Attach letter from responsible public official or community system owner stating position.		

<b>C. On-Site Sewage Management Systems</b>		
Are on-site sewage management systems proposed for each lot?		
Are soil reports, soil maps and soil data sheets from approved Soil Classifier attached?		
<b>III. WATER SUPPLY</b>		
<b>A. Public or Community Water Supply Availability (Existing or Under Construction)</b>		
Name of Water System:		
Nearest Available Main:		
Distance:	Size:	Pressure:
If public or community water system is privately owned, provide information below:		
Owner's Name:		Address:
If community well, has the EPD issued a source approval?		
Has the EPD approved the water supply system?		
<b>B. Future Availability of Water System (Planned, not Under Construction)</b>		
Is a public or community water system proposed?		
Name of Engineering Firm:		Address:
Has the EPD approved plans and specifications?		
Attach letter from responsible official or owner stating status on connection of subdivision to public or community water system.		
<b>C. Individual Water Supply</b>		
Are individual wells planned for each lot?		
<b>IV. COMMENTS AND RECOMMENDATIONS</b>		
DPH Representative:		Title:



GEORGIA DEPARTMENT OF PUBLIC HEALTH

# Manual for On-Site Sewage Management Systems

SECTION N | CERTIFICATION

Environmental Health Section

## SECTION N - CERTIFICATION

### 1) Preface

The Rules of The Department of Public Health, Chapter 511-3-1, provides for the certification and de-certification of septic tank installers, pumpers, maintenance personnel, inspection personnel, and soil scientists. This section establishes standards for these individuals.

### 2) Definitions

- A. **“Certified Level 1 Inspector”**- means an individual who is currently employed by a local board of health; has satisfied the Department’s certification requirements, and performs inspections of onsite sewage management systems.
- B. **“Certified Level 2 Inspector”**- means an individual who is currently employed with a local County Board of Health; has satisfied the Department’s certification requirements, and conducts site evaluations and issue construction permits for the installation and repair of onsite sewage management systems.
- C. **“Certified Septic Tank Installer”** - means an individual who has satisfied the Department’s certification requirements and is engaged in the installation, repair or modification of onsite sewage management systems.
- D. **“Certified Septic Tank Pumper”** - means an individual who has satisfied the Department’s certification requirements and is engaged in the removal, transport and final disposal of septage from onsite sewage management systems.
- E. **“Certified Maintenance Contractor”** - means an individual who has met the Department’s certification requirements and is engaged in the maintenance, routine inspection, evaluation of onsite sewage management systems or advanced treatment units.
- F. **“Certified Septic Tank Company”** - means a business entity (sole proprietorship, corporation limited liability company, or partnership) that is certified by the Department and which employs at least one Department Certified Septic Installer, Pumper or Maintenance Contractor.
- G. **“Registered Engineer/Geologist”** - means an individual who holds a valid certificate of registration as a Registered Geologist issued pursuant to Chapter 19 of Title 43, or who hold a valid certificate of registration as a professional engineer issued pursuant to Chapter 15 of Title 43.
- H. **“Certified Soil Classifier”** - means a person who has been approved by the Department to conduct soil evaluations to determine suitability of a site for an onsite sewage management system.
- I. **“Soil Scientist”** - means a person certified by the Department to perform soil evaluations to conduct soil evaluations to determine suitability of a site for onsite sewage management system.

### 3) Basic Requirements for Initial Certification

- A. Must be at least 18 years of age for Septic Installers, Pumpers and Maintenance Contractors.
- B. Must be at least 21 years of age for Soil Scientists, Registered Engineers and Geologists.
- C. Must not have illegally performed any activities related to the onsite sewage industry within the prior two (2) years of applying for certification.
- D. Must pass all applicable exams, as determined by the Department.
- E. Must pay all applicable fees as determined by the Department.
- F. Must submit a completed application.

#### 4) Additional Certification Requirements

##### A. *Installers, Pumpers and Maintenance Contractors:*

1. Installers must be employed by a Department Certified Septic Tank Company that has paid all applicable fees, submitted all required documents, and is in good standing.
2. A minimum of 70% correct responses on applicable exams is required for certification.

##### B. *Certified Soil Classifier In-Training:*

1. Must hold at least a Bachelor of Science degree from an accredited college or university with a major in agronomy, soil science or related field of science, as approved by the Soil Classifiers Certification Advisory Committee.
2. Must complete a minimum of 30 semester credit hours or equivalent quarter hours in the biological, physical, chemical, or earth sciences with a minimum of 15 semester hours or equivalent quarter hours in approved soil science courses meeting the following distribution:
  - a. A minimum of one course in soil classification, morphology, genesis, and mapping,
  - b. The remaining soil course credits must be in at least three of the following eight categories: introductory soil science, soil fertility, soil microbiology, soil chemistry, soil physics, soil management, soil and land use or soils and the environment, soil mineralogy; or a three-credit maximum in one of the following areas, independent study, geology, or hydrology.
3. Must pass a written examination administered or approved by the Soil Classifiers Certification Advisory Committee.
4. Must work under the direct supervision of a Certified Soil Classifier.

##### C. *Certified Soil Scientists:*

1. Must hold at least a Bachelor of Science degree from an accredited college or university with a major in agronomy, soil science, or a related field of science, as approved by the Soil Classifiers Certification Advisory Committee.
2. Must complete a minimum of 30 semester credit hours or equivalent quarter hours in the biological, physical, chemical, or earth sciences with a minimum of 15 semester

hours or equivalent quarter hours in approved soil science courses meeting the following distribution:

- a. A minimum of one course in soil classification, morphology, genesis and mapping.
  - b. The remaining soil course credits must be in at least three of the following eight categories: introductory soil science, soil fertility, soil microbiology, soil chemistry, soil physics, soil management, soil and land use or soils and the environment, soil mineralogy, or a three-credit maximum in independent study, geology, or hydrology.
3. Has at least four years of verifiable full-time or equivalent part-time experience. Two years of such experience, as determined by the department's soil classifiers advisory committee, shall have been obtained after meeting all the educational requirements of this section under the supervision of a soil classifier who has met the education and experience requirements provided in this section and shall have been spent actively mapping, identifying, and classifying soil features and interpreting the influence of soil features on soil uses, including, but not limited to, conducting soil investigations for determining the suitability of sites for on-site sewage management systems as approved by the department's soil classifiers advisory committee. The remaining two years of such experience, as determined by the department's soil classifiers advisory, shall have occurred prior to, during, or after meeting all the educational requirements of this section and shall have included the utilization of soil science concepts and techniques in mapping, identifying, and classifying soil features and interpreting the influence of soil features on soil uses, including, but not limited to, conducting soil investigations for determining the suitability of sites for on-site sewage management systems as approved by the department's soil classifiers advisory committee.
4. Must successfully complete a written soil science examination as required by the Department's Soil Classifier Certification Advisory Committee.
5. Must pass the Department's Rules and Regulations Exam for Soil Classifiers with a minimum score of 70% correct responses.
6. Must successfully pass a field examination pertaining to soil classification, soil mapping and soil interpretations for on-site sewage management systems.
7. Must submit evidence of current "errors and omissions" insurance or other comparable indemnification in the amount of one million dollars (\$1,000,000). Insurance must always be maintained or the Department's approval to perform soil evaluations is immediately revoked.

*D. Registered Geologists/Engineers:*

1. Maintain registration as a Registered Geologist or engineer in the state of Georgia pursuant to O.C.G.A. Title 43, Chapters 15 and 19. Registrations must always be current or Department approval is immediately revoked.
2. Professional engineers must demonstrate competency in the area of soil classification as it relates to onsite sewage management systems.

3. Successful completion of at least 3 semester hours (or equivalent) of college courses related specifically to soils classification and suitability of sites for on-site sewage management systems.
4. Must submit evidence of current “professional liability” insurance or other comparable indemnification in the amount of one million dollars (\$1,000,000). Insurance must always be maintained or the Department’s approval to perform soil evaluations is immediately revoked.
5. Must successfully complete a written soil science examination as required by the Department’s Soil Classifier Certification Advisory Committee.
6. Must pass the Department’s Rules and Regulations Exam for Soil Classifiers with a minimum score of 70% correct responses.
7. Must successfully pass a field examination pertaining to soil classification, soil mapping and soil interpretations for on-site sewage management systems.

E. *Certified Level 1 Inspector:*

1. Must be employed in good standing in an environmental health program of the Department or County Board of Health as an Environmental Health Specialist 1 or higher.
2. Must complete fifty (50) onsite sewage management system evaluations under the supervision of a certified Level 1 Inspector, or have at least 3 months of work experience in the onsite sewage management program
3. Must submit written approval from the District Environmental Health Director stating the individual has demonstrated proficiency in field inspection activities, including the identification of basic soil hydraulic features and the use of evaluation equipment.
4. Must pass all of the Contractor Certification Level Exams, including the septic tank pumper and portable sanitation contractor examinations with a minimum of 80 % correct responses.

F. *Certified Level 2 Inspector:*

1. Must have completed the Department’s Level 1 Inspection Personnel certification requirements.
2. Must successfully complete the Department’s Onsite Sewage Management Systems Training Class.
3. Must have three (3) months of related work experience as a Level 1 Certified Inspector.
4. Must successfully complete the Department’s Level 2 Soil Certification Training Class.

G. *Exclusion (s)* - Individuals are excluded from having to meet the requirement of ownership or employment with a certified contractor company if:

1. They are employed by a local municipality or governmental entity that perform installations, repairs or relocates onsite sewage management systems under their jurisdiction.
2. A homeowner installing a conventional onsite sewage management system at their primary residence.

## 5) Requirements for Renewal Certification

- A. Certification must be renewed every 2 years based on a standard date established by the Department.
- B. If certification expiration is longer than two (2) years, the applicant must re-take and pass applicable exams.
- C. Must show ownership or proof of employment with a certified septic tank company, health authority, or Certified Soil Classifier.
- D. Must have no unresolved disciplinary action outstanding.
- E. Must satisfy the Department's review of all complaints and judgments received.
- F. Must not have committed any illegal installation or maintenance activities related to the onsite sewage industry during the non-certified period (either non-renewal or decertified).
- G. Must submit evidence of completion of Department approved continuing education:
  - 1. Installers - 8 hours
  - 2. Pumpers and Maintenance Contractors - 6 hours
  - 3. Soil Scientists – 40 hours
  - 4. Inspection Personnel – 8 hours
- H. Special Note for Inspection Personnel:

In accordance with State Law O.C.G.A. 31-3-11 (b), "each employee of a County Board of Health whose duties include enforcing those environmental health regulations of that board of health relating to septic tanks or individual sewage management systems shall be subject to the direction and supervision of the district director of environmental health, although the hiring and termination from employment of such employee shall be subject to the director of that County Board of Health. The employment activities of such employee with regard to environmental health shall be reported to the director of environmental health through the district director of environmental health at least quarterly. The director of environmental health may recommend to that director of that County Board of Health personnel actions, including but not limited to termination, which the director of environmental health deems appropriate for such employee's failure or refusal to comply with the direction of the director of environmental health in the carrying out of the environmental health employment duties of such employee".

## 6) Certification Exams

Certification will be granted to those individuals who successfully complete the written or oral examinations and who comply with all requirements established by the Department. The examinations will be developed by the Department, with the assistance of the Certification Review Committee, and will be structured as a series of modules. The basic residential module will be composed of questions about "conventional on-site sewage management systems" as defined in the current rules of the Department and this Manual. Additional modules (commercial, drip and area fill mound) will address each of a variety of alternative sewage disposal methods currently exist or will be developed in the future. It is recognized that such

systems are typically complex in nature and vary significantly in installation from conventional system design. A commercial certification is required for contractors installing a system designed for a flow of 2,000 gallons per day or more. Certification will indicate all types of systems for which successful testing has been accomplished.

## **7) Certification Fees**

- A. A \$50 per examination fee will be required of those individuals who wish to become a certified contractor.
- B. A \$400.00 company certification fee will be required every two years based on a standard renewal date as established by the Department.
- C. Company certification fee for new companies during the 2nd year of the renewal period will be the pro-rated amount of \$200.00.
- D. A \$100.00 late fee will be required for companies renewing after the Department's deadline.
- E. There is a \$35.00 fee for returned checks and /or re-issuance of a certification card.
- F. Soil Scientist Fees - A \$100 application processing/examination fee will be required of those persons who wish to be considered for certification in the on-site sewage management program. A \$400 certification fee will be required every two years based on a standard renewal date as established by the Department.

## **8) Establishment of the Certification Review Committee**

There shall be established a Certification Review Committee that assists the Department with certification, recertification and decertification of all individuals required to be certified under 511-3-1 with the exception of Soil Classifiers. The Certification Review Committee shall be composed of two individuals from the state environmental health program, one district environmentalist, one county environmentalist, two individuals who are certified under the "Septic Tank Contractor, or Sewage Pumper" sections of this chapter and three consumer advocates appointed by the Department.

The Committee, will assist the Department with the following:

- A. Developing and revising certification exams;
- B. Reviewing complaints against individuals and companies;
- C. Recommending decertification of those individuals and companies who fail to adhere to the standards for certification established in this section;
- D. Reviewing the content of educational programs and events and recommending appropriate continuing education credit at the request of the Department;
- E. Reviewing the established criteria for certification in the assigned specialties;
- F. Performing such other activities as would be appropriate to manage the continued operation of the certification effort.

## **9) Establishment of the Soil Classifiers' Certification Advisory Committee**

The Department shall appoint nine individuals from the following professional disciplines who will oversee the certification of “Soil Classifiers”. This body shall be known as the “Soil Classifiers’ Certification Advisory Committee”. It shall be comprised of three environmentalists employed in the environmental health program of County Boards of Health or the Department of Public Health (county, district and state), one currently certified soil scientist, two soil scientists from academia, a Registered Engineer, a Registered Geologist and a member at large appointed by the Department.

The Advisory Committee shall be responsible for:

- A. Reviewing applications for certification; administering certification examinations;
- B. Reviewing and responding to complaints concerning poor quality work and unethical practices;
- C. Recommending disciplinary action;
- D. Recommending initial certification and recertification of individuals;
- E. Reviewing the content of educational programs and events and making recommendations regarding continuing education credits,
- F. Performing other activities as would be appropriate to the operation and maintenance of the Soil Classifiers certification program.



GEORGIA DEPARTMENT OF PUBLIC HEALTH

# Manual for On-Site Sewage Management Systems

SECTION O | APPENDIX

Environmental Health Section

## SECTION O – APPENDIX

### 1) Appendix 1 - Pressure Distribution Network Design

Septic tank effluent or other pretreated effluent can be distributed in a soil treatment/dispersal unit either by trickle, dosing or uniform distribution. Trickle flow, known as gravity flow, occurs each time wastewater enters the system through 4" perforated pipe. The pipe does not distribute the effluent uniformly but concentrates it in several areas of the absorption unit. Dosing is defined as pumping or siphoning a large quantity of effluent into the 4" inch perforated pipe for distribution within the soil absorption area. It does not give uniform distribution but does spread the effluent over a larger area than does gravity flow. Uniform distribution, known as pressure distribution, distributes the effluent somewhat uniformly throughout the absorption area. This is accomplished by pressurizing relatively small diameter pipes containing small diameter perforations spaced uniformly throughout the network and matching a pump to the network.

This material has been extracted and modified from a paper entitled "Design of Pressure Distribution Networks for Septic Tank- Soil Absorption Systems" by Otis, 1981. It also includes material from the "Pressure Distribution Component Manual for Private Onsite Wastewater Treatment Systems" by the State of Wisconsin, Department of Commerce, 1999.

The design procedure is divided into two sections. The first part consists of sizing the distribution network which distributes the effluent in the aggregate and consists of the laterals, perforations, and manifold. The second part consists of sizing the force main, pump, dose chamber, and suitable controls.

#### A. Design of the Distribution Network:

**Step 1: Configuration of the network.** The configuration and size of the absorption field must meet all soil and site criteria. Once any limitations have been established, the distribution network can be designed.

**Step 2: Determine the length of the laterals.** Lateral lengths are defined as the distance length from the manifold to the end of the lateral. For a center manifold it is approximately one half the length of the absorption area. For end manifolds it is approximately the length of the absorption area. The lateral should end about 6" to 12" from the end of the absorption bed.

**Step 3: Determine the perforation size, spacing, and position.** The size of the perforation or orifices, spacing of the orifices and the number of orifices must be matched with the flow rate to the network.

**Size:** The typical perforation diameter has been 1/4", but with the requirement of Class I effluent, carry-over particles have been greatly reduced allowing smaller diameter orifices

to be used. Orifices as small as 1/8" are commonly used in sand filter design, however orifice shields are generally used to protect the orifice from being compromised by the aggregate. Smaller diameter perforations are also at risk from burrs when drilling. Shop drilling the orifices under tight specifications reduces the concern. A sharp drill bit will drill a much more uniform orifice than a dull drill. Replace drills often. Remove all burrs and filing from pipe before assembling it. As a compromise, one might consider using 5/32" or 3/16" diameter orifices which will allow for more orifices than if 1/4" orifices were used.

**Spacing:** It is important to distribute the effluent as uniformly as possible over the system to increase effluent/soil contact time and maximize treatment efficiency. Typical spacing has been 30-36" but some designers have set spacing further apart to reduce pipe and pump sizes. Typical spacing for beds has been 6 ft<sup>2</sup>/orifice (J.C.Converse; 2000).

**Positioning:** In cold climates, it is essential that the laterals drain after each dose event to prevent freezing. Because of the longer laterals normally encountered in mounds, the orifices are typically placed downward for draining as it is much more difficult to slope the lateral toward the manifold/force main because of their greater length.

**Step 4: Determine the lateral pipe diameter.** Based on the selected perforation size and spacing, Figures A-1a through A-3b should be used to select the lateral diameter. Lateral diameter is also used to determine dose volume. (Table O.1.5).

**Step 5: Determine the number of perforations per lateral.**

Use:  $N = (p/x) + 0.5$       for center feed/center manifold  
 $N = (p/x) + 1$       for end fed/end manifold

Where:

N = number of perforations,

p = lateral length in feet and

x = perforation spacing in feet.

Round number off to the nearest whole number.

**Step 6: Determine the lateral discharge rate.** Based on the distal pressure selected, Table O.1.1 gives the perforation discharge rate. The designer must choose an operational pressure (in units of feet) at a distal point. This is the starting point of selecting a pump and determining if the system has equal distribution.

**Step 7: Determine the number of laterals and the spacing between laterals.** Since the criteria of 6 ft<sup>2</sup>/orifice is the guideline, the orifice spacing and laterals spacing are interrelated. For absorption area widths of 3 ft, one distribution pipe along the length of trench requires an orifice spacing of 2 ft. For a 6 ft wide absorption area with the same configuration it would require orifice spacing of 1 ft. or the system could utilize a manifold with several laterals and have better coverage. **Ideally, the best option is to position the**

perforations to serve a square such as a 2.5' by 2.5' area but that may be difficult to do but a 2' by 3' is much better than a 6' by 1' area.

**Step 8:** Calculate the manifold size and length. The manifold length is the length pipe between the outer laterals. For smaller systems assume the manifold size is the same as the force main diameter since the manifold is an extension of the force main. There are procedures for determining the manifold size for larger systems (Table O.1.2) from Otis, 1981.

**Step 9:** Determine the network discharge rate. This value is used to size the pump. Take the lateral discharge rate and multiply it by the number of laterals or take the perforation discharge rate and multiply it by the number of perforations.

## **B. Design and Selection of the Force Main, Pump, Dose Chamber and Controls.**

**Step 1:** Develop a system performance curve. The system performance curve predicts how the distribution system performs under various flow rates and heads. The flow rate is a function of the total head that the pump works against. As the head becomes larger, the flow rate decreases but the flow rate determines the network pressure and thus the relative uniformity of discharge throughout the distribution network. The best way to select the pump is to evaluate the system performance curve and the pump performance curve. Where the two curves cross, is the point where the system operates relative to flow rate and head.

The total dynamic head that the pump must work against is the:

1. System network head (1.3 x distal pressure)
2. Elevation difference between the pump and the highest point in the system.
3. Friction loss in the force main.

The system network head is the pressure maintained in the system during operation to assure relatively uniform flow through the orifices. The 1.3 multiplier relates to the friction loss in the manifold and laterals which assumes that the laterals and manifold are sized correctly.

The elevation difference is between the pump and the highest point in the system in feet (the pump industry uses the bottom of the pump tank).

The friction loss in the force main between the pump tank and the inlet to the network is determined by using Table O.1.3. Equivalent length for fittings should be included. Equivalent lengths are found in Table O.1.4.

**Step 2: Determine the force main diameter.** The force main diameter is determined from Table O.1.2. The number of laterals and/or length of manifold should not exceed these maximums.

**Step 3: Select the pressurization unit.** Using pump performance curves, select the pump that best matches the required flow rate at the operating head. Plot the pump performance curve on the system curve. Then determine if the pump will produce the flow rate at the required head. Do not undersize the pump. It can be oversized but will be costlier.

**Step 4: Determine the dose volume required.** The lateral pipe void volume determines the minimum dose volume. The recommended dose volume is 10 times the lateral volume. It is required that the system be timed dosed daily based on the design flow. Small doses need to be applied; however, sufficient volume is needed to distribute the effluent uniformly across the network. Table O.1.5 gives the void volume for various size pipes.

**Step 5: Size the dose tank.** For residential applications, the dose tank must be large enough to provide for:

- a. The dose volume.
- b. The dead space resulting from placement of the pump on a concrete block.
- c. A few inches of head space for floats
- d. 24 hour reserve capacity based on 150 gallons per bedroom.

The pump tank must have sufficient surge capacity to allow for timed dosing. See Section E of the manual for additional information and requirements for dosing other applications.

**Step 6: Select controls and alarms.** Select quality controls and alarms. Follow electrical code for electrical connections.

### **Design Example 1 - Pressure Distribution Network for Bed and Mound Applications**

This example will follow these steps to design a pressure distribution network for a bed system. All requirements found in Section F; *Absorption Field Methods and Guidelines for Class I Effluent* of the manual must be followed.

The bed absorption area is 452 ft<sup>2</sup> (113 ft long by 4 ft wide). The force main is 125 ft long and the elevation difference is 9 ft with three 90° elbows. Central manifold distribution system will be used.

#### **A. Design of the distribution network.**

##### **1. Configuration of the network.**

This is a narrow absorption bed on a sloping site. ( $4' \times 113' = 452 \text{ ft}^2$ )

## 2. Determine the lateral length.

Use a center feed, the lateral length is:

$$\begin{aligned} \text{Lateral Length} &= (B / 2) - 0.5 \text{ ft} && \text{Where: B = bed absorption length.} \\ &= (113 / 2) - 0.5 \text{ ft} \\ &= \mathbf{56 \text{ ft}} \end{aligned}$$

## 3. Determine the perforation spacing and size.

### Perforation spacing:

It is recommended that each perforation covers a maximum area of  $6 \text{ ft}^2$ . The absorption area is 4 ft wide.

Two laterals on each side of the center.

$$\begin{aligned} \text{Spacing} &= (\text{area/orifice} \times \text{no. of laterals}) / (\text{absorption area width}) \\ &= (6 \text{ ft}^2 \times 2) / (4 \text{ ft}) \\ &= \mathbf{3 \text{ ft.}} \end{aligned}$$

**Best option:** Ideally, the best option is to position the perforations to serve a square but that may be difficult to do. In this example, each perforation serves a 2' by 3' rectangular area. With an absorption area of 6 ft wide with one lateral down the center, perforation spacing would be 1 ft apart and the perforation would serve an area of 6 by 1 ft which would be undesirable.

### Perforation size:

Smaller diameter perforations may reduce system discharge flow rate, reduced pump requirements, at the same time increasing the number of orifices benefitting equal distribution through out the system. This example uses **3/16" perforations**.

## 4. Determine the lateral diameter.

Using **Fig. A-2a (3/16")** to determine the minimum lateral diameter:

The laterals on each side of the center manifold each has the length of 56 ft with 3 ft spacing between orifices, these point to a **lateral diameter of 1.5"**.

## 5. Determine number of perforations per lateral and number of perforations.

Using 3.0 ft spacing in 56 ft a lateral yields 19 perforations each:

$$N = (p/x) + 0.5 = (56 / 3.0) + 0.5 = 19 \text{ perforations/lateral}$$

$$\text{Number of perforations} = 4 \text{ lateral} \times 19 \text{ perforations/lateral} = 76$$

**Check** - Maximum of 6 ft<sup>2</sup>/ perforation =

$$\text{Number of perforations} = 412 \text{ sqft}/6 \text{ ft}^2 = 75; (76 > 75, \text{ is okay})$$

### **6. Determine lateral discharge rate (LDR).**

Using network pressure (distal) pressure of 3.5 ft and 3/16" diameter perforations, Table O.1.1 gives a discharge rate of 0.78 gpm, regardless of the number of laterals.

$$\text{LDR} = 0.78 \text{ gpm/perforation} \times 19 \text{ perforations} = \mathbf{14.8 \text{ gpm/lateral}}$$

### **7. Determine the number of laterals.**

This was determined in Step 3 and 4.

Two laterals on each side of center feed = **4 laterals spaced 2 ft apart.**

### **8. Calculate the manifold size.**

The force main diameter is determined from Table O.1.2 on the manual. The manifold is generally the same size as force main as it is an extension of the force main or it could be one size smaller. This example will use a **2" manifold.**

### **9. Determine network discharge rate (NDR)**

$$\text{NDR} = 4 \text{ laterals} \times 14.8 \text{ gpm/lateral} = 59.2 \text{ or } \mathbf{60 \text{ gpm}}$$

Pump has to discharge a minimum of 60 gpm against a total dynamic head yet to be determined.

### **10. Total dynamic head.**

Sum of the following:

$$\begin{aligned} \text{System head} &= 1.3 \times \text{distal head (ft)} \\ &= 1.3 \times 3.5 \text{ ft} \\ &= \mathbf{4.5 \text{ ft}} \end{aligned}$$

**Elevation head = 9.0 ft** (Pump shut off to network elevation)

**Head Loss in Force Main** = Tables O.1.4 and O.1.4 for 60 gallons and 125 ft of force main and 3 elbows.

Equivalent length of pipe for fittings can be found in Table O.1.3

3- 2" 90° elbows @ 9.0 ft each = **27 ft** of pipe equivalent.

Head Loss through 100' of PVC pipe can be found in Table O.1.2

125' of 2" force main plus the head loss in the fittings equals

$$= 7.0 (125 \text{ ft} + 27 \text{ ft})/100 = \mathbf{10.6 \text{ ft}}$$

**Total Dynamic Head (TDH) = Sum of the three**

TDH = System head + Elevation head + Head Loss in Force Main

$$4.5 + 9 + 10.6 = 24.1 \text{ ft (2" force main)} = \mathbf{24 \text{ ft of head}}$$

## 11. Pump Summary

Pump must discharge **60 gpm** against a head of **24 ft** with 2" force main.

These are the calculated flow and head values. The actual flow and head will be determined by the pump selected. A system performance curve plotted against the pump performance curve will give a better estimate of the flow rate and total dynamic head the system will operate under.

## 12. Select the Pump

Using a performance curve from the pump manufacture, the point where the flow rate intersects (60 gpm) the total dynamic head (24 ft) should fall under the pump curve. A pump can be over sized, but undersized pumps will lead to failure in performance and/or longevity.

### 4. Determine the dose volume.

Determine the pipe void volume from Table O.1.5. Use 10 times the lateral void volume.

**Dose Volume = 10 x length of lateral x number of laterals x Void volume**

Lateral diameter =	1.5"
Lateral Length =	56'
No. of laterals =	4
Void volume =	0.092 gal/ft

$$10 \times 56 \times 4 \times 0.092 = \mathbf{206 \text{ gal./dose}}$$

## 5. Size the dose tank.

The pump tank size should be based on the dose volume, 24 hour storage volume, and room for a block beneath the pump and control space. This example is for a residential application, additional information on dosing requirements can be found in Section E of the manual.

## 6. Select controls and alarm.

**Time Dosing:** The advantage of time dosing provides more frequent doses and levels out peak flows to the bed.

### Design Example 2 - Pressure Distribution Network for Trench Applications

Design a pressure network for a trench absorption field consisting of five trenches, each 3 ft wide by 40 ft. long, and spaced 9 ft apart center to center.

**Step 1:** Select lateral length. Two layouts are suitable for this system: central manifold or end manifold (Table O.1.2). For a central manifold design, ten 20-ft laterals are used; for an end manifold design, five 40-ft laterals are required. The end manifold design is used in this example.

**Step 2:** Select hole diameter and hole spacing for laterals. For this example, ¼ in. diameter holes spaced every 30 in. are used, although other combinations could be used.

**Step 3:** Select lateral diameter. For ¼-in. hole diameter, 30-in. hole spacing, and 40-ft length, either a 1¼-in. diameter or 1½-in diameter lateral could be used. The 1½-in. diameter is selected for this example.

**Step 4:** Calculate lateral discharge rate. By maintaining higher pressures in the lateral, small variations in elevation along the length of the lateral and between laterals do not significantly affect the rates of discharge from each hole. This reduces construction costs but increases pump size. For this example, a 2-ft head is to be maintained in the lateral. For a ¼-in. hole at 2 ft. of head. Table O.1.6 shows the hole discharge rate to be 1.04 gpm.

40-ft lateral length with holes spaced 30 inches apart:

$$\begin{aligned} \text{Number of holes/lateral} &= 40 \text{ ft. lateral length} / 2.5 \text{ ft. hole spacing} \\ &= 16 \text{ holes} \\ \text{Lateral discharge rate} &= (16 \text{ holes/lateral}) \times (1.04 \text{ gpm/hole}) \\ &= 16.6 \text{ gpm/lateral} \end{aligned}$$

**Step 5:** Select manifold size. There are to be five laterals spaced 9ft apart. A manifold length of 36 ft is therefore required. For five laterals and 16.6 gpm/lateral, Table O.1.1 indicates that a 3-in. diameter manifold is required.

**Step 6:** Determine minimum dose volume (Table 23.O).

With:	lateral diameter	= 1½ in.
	lateral length	= 40 ft.
	number of laterals	= 5
Then:	pipe volume	= 3.7 gal
Minimum	dose volume	= approx. 200 gal.

The final dose volume may be larger than this minimum depending on the desired number of doses per day

**Step 7:** Determine minimum discharge rate.

Minimum discharge rate	= (5 laterals) x (16.6 gpm/lateral)
	= 83 gpm

See Figure 21.F for distribution network designed for a trench system.

**Step 8:** Select proper pump or siphon.

For a pump system, the total pumping head of the network must be calculated. This is equal to the elevation difference between the pump and the distribution lateral inverts, plus friction loss in the pipe that delivers the wastewater from the pump to the network at the required rate, plus the desired pressure to be maintained in the network (the velocity head is neglected). A pump is then selected that is able to discharge the minimum rate (83 gpm) at the calculated pumping head.

For a siphon system, the siphon discharge must be elevated above the lateral inverts at a distance equal to the friction losses and velocity head in the pipe that delivers the wastewater from the siphon to the network at the required rate, plus the desired pressure to be maintained in the network.

For this example, assume the dosing tank is located 25 ft from the network inlet, and the difference in elevation between the pump and the inverts of the distribution laterals is 5 feet.

➤ Pump Option Calculation (assume 3-in. diameter delivery pipe):

Friction loss in 3-in. pipe at 83 gpm (from Table O.1.7)	= 1.38 + 3/10 (1.73 - 1.38)
	= 1.49 ft/100ft
Friction loss in 25ft	= 1.49 ft/100 ft x 25ft
	= 0.4ft
Elevation Head	= 5.0ft
Pressure to maintain	= 2.0ft.
Total pumping head	= 7.4 ft

Therefore, a pump capable of delivering at least 83 gpm against 7.4 feet of head is required. This information is found in pump curves.

➤ Siphon Option Calculation (assume 4-in. Diameter delivery pipe)

$$\begin{aligned} \text{Friction loss in 4-in pipe at 83 gpm (from Table O.1.7):} \\ &= 0.37 + 3/10 (0.46 - 0.37) \\ &= 0.4\text{ft}/100 \text{ ft} \end{aligned}$$

$$\begin{aligned} \text{Friction loss in 25ft} &= (0.4 \text{ ft}/100 \text{ ft}) \times (25 \text{ ft}) \\ &= 0.10 \text{ ft} \end{aligned}$$

Velocity head in delivery pipe:

$$\text{Discharge rate} \quad (@ 83 \text{ gpm}) = 0.185 \text{ ft}^3/\text{sec}$$

$$\text{Area} = (\frac{1}{4})\pi (4/12)^2 = 0.087 \text{ ft}^2$$

$$\text{Velocity} = 0.185 \text{ ft}^3/\text{sec} = 2.13\text{ft}/\text{sec}$$

$$\begin{aligned} \text{Velocity Head} &= \frac{(\text{Velocity})^2}{2g} \\ &= \frac{(2.13 \text{ ft}/\text{sec})^2}{2 (32.3 \text{ ft}/\text{sec})} \\ &= 0.07 \text{ ft} \end{aligned}$$

$$\text{Pressure to maintain} = 2.0 \text{ ft.}$$

$$\text{Total} = 2.2 \text{ ft}$$

Minimum elevation of the siphon discharge invert above the lateral inverts must be 2.2 ft.

In summary, the final network design consists of five 40-ft laterals 1½-in. in diameter connected with a 36-ft end manifold 3-in. in diameter, with the inlet from the dosing tank at one end of the manifold. The inverts of the laterals are perforated with ¼-in. holes spaced every 30 in.

## CONSTRUCTION AND MAINTENANCE

Good common sense should prevail when constructing and maintaining these systems. Water tight construction practices must be employed for all tanks. Surface runoff must be diverted away from the system. Any settling around the tanks must be filled with the soil brought to grade or slightly above to divert surface waters.

**Table O.1.1 Perforation Discharge Rates (GPM)**

Distal Pressure (ft)	Perforation Diameter (in)					
	1/8	5/32	3/16	1/4	5/16	3/8
	-----GPM-----					
1.0	0.18	0.29	0.41	0.74	1.15	1.66
1.5	0.23	0.35	0.50	0.90	1.41	2.03
2.0	0.26	0.41	0.58	1.04	1.63	2.34
2.5	0.29	0.45	0.66	1.17	1.82	2.62
3.0	0.32	0.50	0.72	1.28	1.99	2.87
3.5	0.34	0.54	0.78	1.38	2.15	3.10
4.0	0.37	0.57	0.83	1.47	2.30	3.32
4.5	0.39	0.61	0.88	1.56	2.44	3.52
5.0	0.41	0.64	0.93	1.65	2.57	3.71

Values were calculated as:  $gpm = (11.79 \times d^2 \times \sqrt{h})$   
 Where:  $d$  = orifice dia. in inches and  $h$  = head feet.

**Table O.1.2 Maximum Manifold Length (ft) For Various Manifold Diameters Given the Lateral Discharge Rate and Lateral Spacing (from: Otis, 1981)**

Lateral Discharge Rate End Manifold / Center Manifold	Manifold Diameter = 1¼"	Manifold Diameter = 1½"	Manifold Diameter = 2"	Manifold Diameter = 3"	Manifold Diameter = 4"	Manifold Diameter = 5"				
	Lateral Spacing (ft)					Lateral Spacing (ft)				
	2 4 6 8 10	2 4 6 8 10	2 4 6 8 10	2 4 6 8 10	2 4 6 8 10	2 4 6 8 10	2 4 6 8 10			
10 / 5	4 8 6 8 10	10 8 12 16 20	12 16 24 24 30	26 40 48 56 70	42 64 84 96 110	84 134 174 200 240				
20 / 10	4 4 6	4 4 6 8 10	6 8 12 16 20	16 24 30 32 40	26 40 54 64 70	54 84 106 128 150				
30 / 15	2	2 4 6	4 8 6 8 10	12 16 24 24 30	20 26 36 48 60	42 64 84 96 110				
40 / 20			4 4 6 8 10	10 12 18 16 20	16 24 30 32 40	34 52 66 80 90				
50 / 25			2 4 6 8	8 12 12 16 20	14 20 24 32 40	30 44 60 72 80				
60 / 30			2 4	8 12 18 16 20	12 16 24 24 30	26 40 48 64 70				
70 / 35			2	6 8 12 8 10	10 16 18 24 30	24 36 48 56 60				
80 / 40			2	6 8 6 8 10	10 12 18 16 20	22 32 42 46 60				
90 / 45			2	4 8 6 8 10	8 12 18 16 20	20 28 42 46 50				
100 / 50				4 4 6 8 10	8 12 12 16 20	18 28 36 40 50				
110 / 55				4 4 6 8 10	8 12 12 16 20	16 24 36 40 40				
120 / 60				4 4 6 8 10	6 8 12 16 10	16 24 30 32 40				
130 / 65				4 4 6 8 10	6 8 12 16 10	14 24 30 32 40				
140 / 70				2 4 6 8	6 8 12 8 10	14 20 24 32 40				
150 / 75				2 4 6	6 8 12 8 10	14 20 24 32 30				
160 / 80				2 4 6	6 8 6 8 10	12 20 24 32 30				
170 / 85				2 4 6	4 8 6 8 10	12 20 24 24 30				
180 / 90				2 4	4 8 6 8 10	12 16 24 24 30				
190 / 95				2 4	4 8 6 8 10	12 16 18 24 30				
200 / 100				2 4	4 4 6 8 10	10 16 18 24 30				

**Table O.1.3 Friction Loss in Schedule 40 Plastic Pipe**  
(ft/100 ft), Based on Hazan-Williams; C = 150

Flow (GPM)	Pipe Diameter (Inches)								
	1"	1 ¼"	1 ½"	2"	3"	4"	6"	8"	10"
1	0.07								
2	0.28	0.07							
3	0.60	0.16	0.07						
4	1.01	0.25	0.12						
5	1.52	0.39	0.18						
6	2.14	0.55	0.25	0.07			Velocities in this area are below 2 ft/sec.		
7	2.89	0.76	0.36	0.10					
8	3.63	0.97	0.46	0.14					
9	4.57	1.21	0.58	0.17					
10	5.50	1.46	0.70	0.21					
11		1.77	0.84	0.25					
12		2.09	1.01	0.30					
13		2.42	1.17	0.35					
14		2.74	1.33	0.39					
15		3.06	1.45	0.44	0.07				
16		3.49	1.65	0.50	0.08				
17		3.93	1.86	0.56	0.09				
18		4.37	2.07	0.62	0.10				
19		4.81	2.28	0.68	0.11				
20		5.23	2.46	0.74	0.12				
25			3.75	1.10	0.16				
30			5.22	1.54	0.23				
35				2.05	0.30	0.07			
40				2.62	0.39	0.09			
45				3.27	0.48	0.12			
50				3.98	0.58	0.16			
60					0.81	0.21			
70					1.06	0.28			
80					1.38	0.37			
90					1.73	0.46			
100					2.09	0.55	0.07		
150						1.17	0.16		
200							0.28	0.07	
250							0.41	0.11	
300							0.58	0.16	
350							0.78	0.20	0.07
400							0.99	0.26	0.09
450							1.22	0.32	0.11
500								0.38	0.14
600								0.54	0.18
700								0.72	0.24
800									0.32
900									0.38
1000									0.46

**Table O.1.4 Friction losses through plastic fittings in terms of equivalent lengths of pipe**  
(Sump and Sewage Pump Manufacturers, 1998)

Type of Fitting	-----Nominal size fitting and pipe -----					
	1¼	1½	2	2½	3	4
90° Elbow	7.0	8.0	9.0	10.0	12.0	14.0
45° Elbow	3.0	3.0	4.0	4.0	6.0	8.0
STD. Tee (Diversion)	7.0	9.0	11.0	14.0	17.0	22.0
Check Valve	11.0	13.0	17.0	21.0	26.0	33.0
Coupling/ Quick Disconnect	1.0	1.0	2.0	3.0	4.0	5.0
Gate Valve	0.9	1.1	1.4	1.7	2.0	2.3

**Table O.1.5 Void volume for various diameter pipes.**

Nominal Pipe Size (In.)	Void Volume (gal./ft)
3/4	0.023
1	0.041
1¼	0.064
1½	0.092
2	0.163
3	0.367
4	0.650
6	1.469

**Table O.1.6 Nomograph for Determining the Minimum Dose Volume**

Nomograph for Determining the Minimum Dose Volume for a Given Lateral Length and Diameter, and Number of Laterals (See Section O-VII; for Additional Dose Calculations)

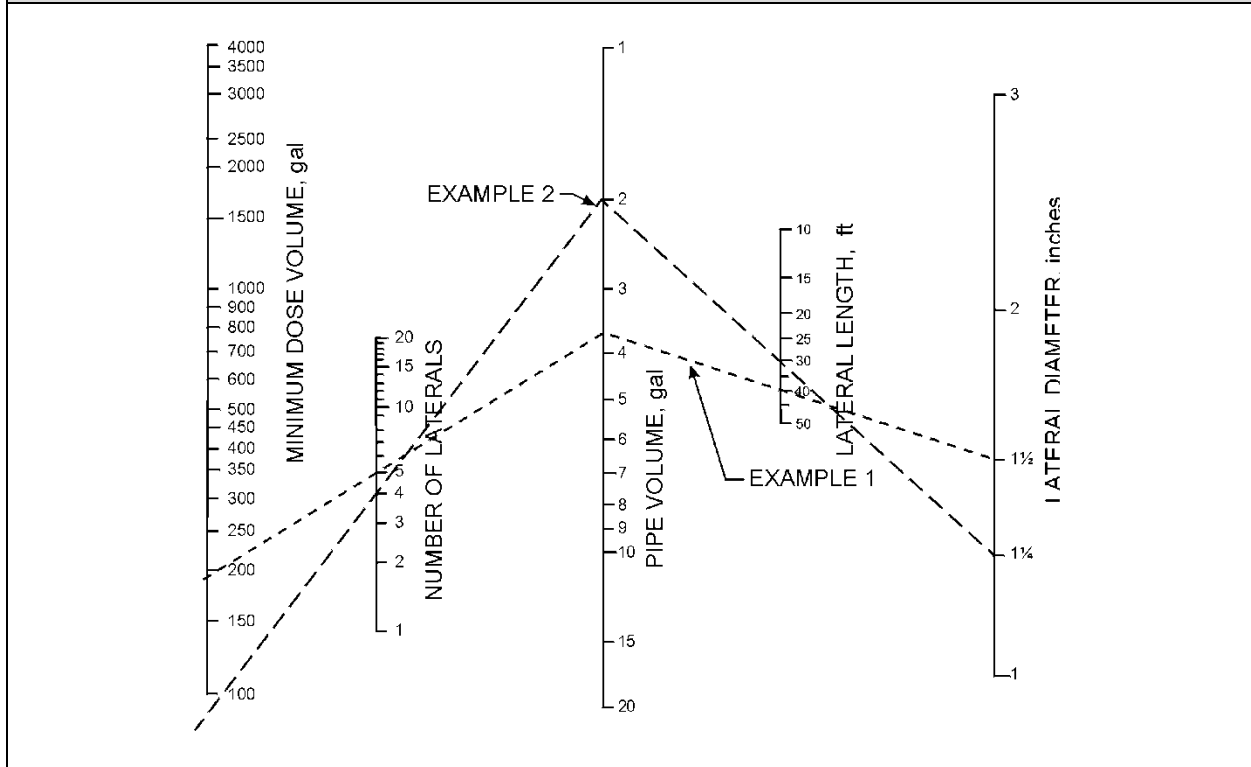

**Table O.1.7 Recommended Manifold Diameters**

Lateral Length (ft)		LATERAL DIAMETER (IN)																																		
		Hole Diameter (in)					Hole Diameter (in)					Hole Diameter (in)					Hole Diameter (in)					Hole Diameter (in)														
		1/4					5/16					3/8					7/16					1/2														
		Hole Spacing (ft)					Hole Spacing (ft)					Hole Spacing (ft)					Hole Spacing (ft)					Hole Spacing (ft)														
2 3 4 5 6 7					2 3 4 5 6 7					2 3 4 5 6 7					2 3 4 5 6 7					2 3 4 5 6 7																
10	1"					1"					1"					1"					1"															
15	1"					1"					1"					1 1/4"					1 1/4"															
20	1"					1"					1 1/2"					1 1/2"					1 1/2"															
25	1"					1 1/4"					1 1/4"					1 1/4"					1 1/4"															
30	1 1/2"					1 1/2"					1 1/2"					1 1/2"					1 1/2"															
35	1 1/2"					1 1/2"					1 1/2"					1 1/2"					1 1/2"															
40	1 1/2"					1 1/2"					1 1/2"					1 1/2"					1 1/2"															
45	1 1/2"					1 1/2"					1 1/2"					1 1/2"					1 1/2"															
50	1 1/2"					1 1/2"					1 1/2"					1 1/2"					1 1/2"															

*Example 7-3* (at 30 ft lateral length, 2 ft spacing, 1 1/4" diameter)  
*Example 7-2* (at 40 ft lateral length, 2 ft spacing, 1 1/2" diameter)

<sup>a</sup> Computed for plastic pipe only. The Hazen-Williams equation was used to compute headlosses through each pipe segment (Hazen-Williams C=150). The orifice equation for sharp-edged orifices (discharge coefficient = 0.6) was used to compute the discharge rates through each orifice. The maximum lateral length for a given hole and spacing was defined as that length at which the difference between the rates of discharge from the distal end and the supply end orifice reached 10 percent of the distal end orifice discharge rate

Central Manifold		MANIFOLD DIAMETER (IN)																																																
		Manifold Length (ft)																																																
		5				10				15				20				25				30				35				40				45				50												
		Number of Laterals with Central Manifold																																																
Central Manifold		Flow per Lateral (gpm)																																																
		4		6		8		10		12		14		16		18		20		22		24		26		28		30		32		34		36		38		40		42		44		46		48		50		
5	1"		1 1/4"		1 1/2"		2"		2"		2"		2"		2"		2"		2"		2"		2"		2"		2"		2"		2"		2"		2"		2"		2"		2"		2"		2"		2"		2"	
10	1 1/4"		1 1/2"		2"		2"		2"		2"		2"		2"		2"		2"		2"		2"		2"		2"		2"		2"		2"		2"		2"		2"		2"		2"		2"		2"			
15	1 1/2"		2"		2"		2"		2"		2"		2"		2"		2"		2"		2"		2"		2"		2"		2"		2"		2"		2"		2"		2"		2"		2"		2"		2"			
20	2"		2"		2"		2"		2"		2"		2"		2"		2"		2"		2"		2"		2"		2"		2"		2"		2"		2"		2"		2"		2"		2"		2"		2"			
25	2"		2"		2"		2"		2"		2"		2"		2"		2"		2"		2"		2"		2"		2"		2"		2"		2"		2"		2"		2"		2"		2"		2"		2"			
End Manifold		Number of Laterals with End Manifold																																																
		2		3		4		5		6		7		8		9		10		11		12		13		14		15		16		17		18		19		20		21		22								
10	5		6		8		10		12		14		16		18		20		22		24		26		28		30		32		34		36		38		40		42		44		46		48		50			
20	5		6		8		10		12		14		16		18		20		22		24		26		28		30		32		34		36		38		40		42		44		46		48		50			
30	5		6		8		10		12		14		16		18		20		22		24		26		28		30		32		34		36		38		40		42		44		46		48		50			
40	5		6		8		10		12		14		16		18		20		22		24		26		28		30		32		34		36		38		40		42		44		46		48		50			
50	5		6		8		10		12		14		16		18		20		22		24		26		28		30		32		34		36		38		40		42		44		46		48		50			

*Example 7-2* (at 35 ft manifold length, 10 laterals, 3" diameter)

*Example 7-2* (at 15 ft manifold length, 4 laterals, 3" diameter)

<sup>a</sup> Computed for plastic pipe only. The Hazen-Williams equation used to compute headlosses through each segment (Hazen-Williams C = 150). The maximum length for a given lateral discharge rate and spacing was defined as that length at which the difference between the heads at the distal and supply ends of the manifold exceeded 10 percent of the head at the distal end.

**Figures for Lateral Diameter Based on Orifice Spacing**  
**Fig. A-1a – A4b**

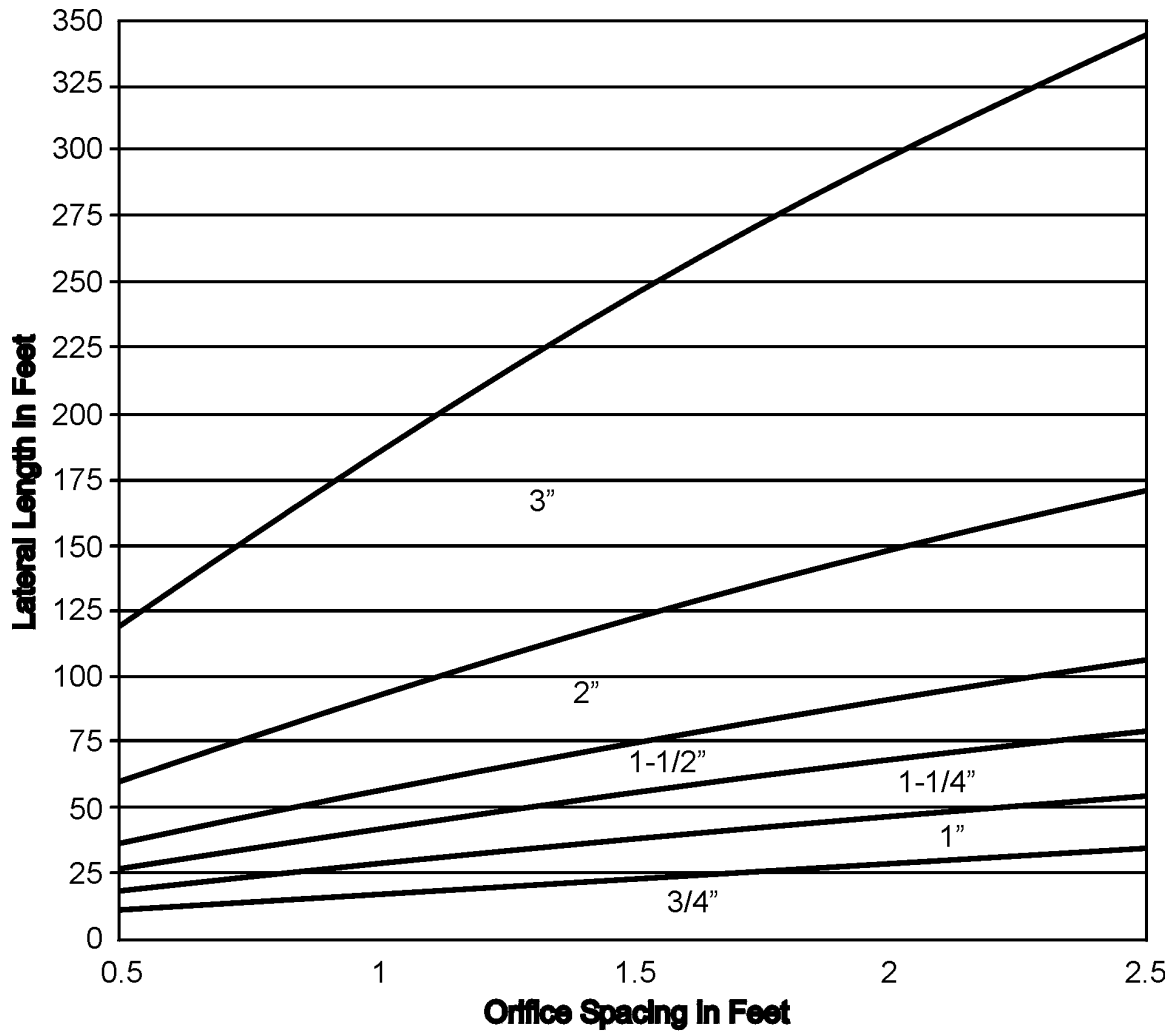

Fig. A-1a. Minimum lateral diameter based on orifice spacing for 1/8 in. diameter orifices (Wisc. Dept. Of Commerce, 1999)

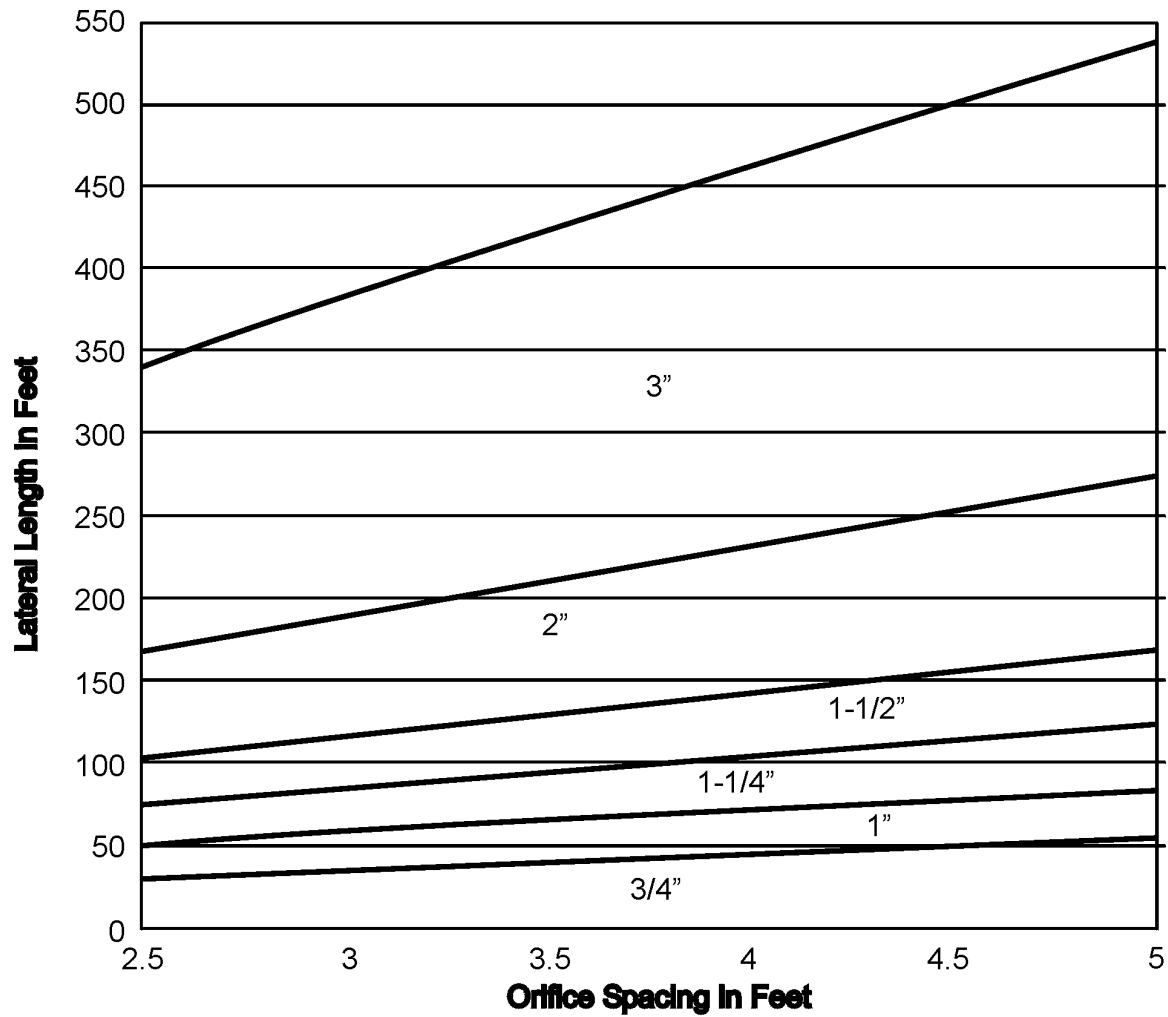

Fig. A-1b. Minimum lateral diameter based on orifice spacing for 1/8 in. diameter orifices (Wisc. Dept. Of Commerce, 1999)

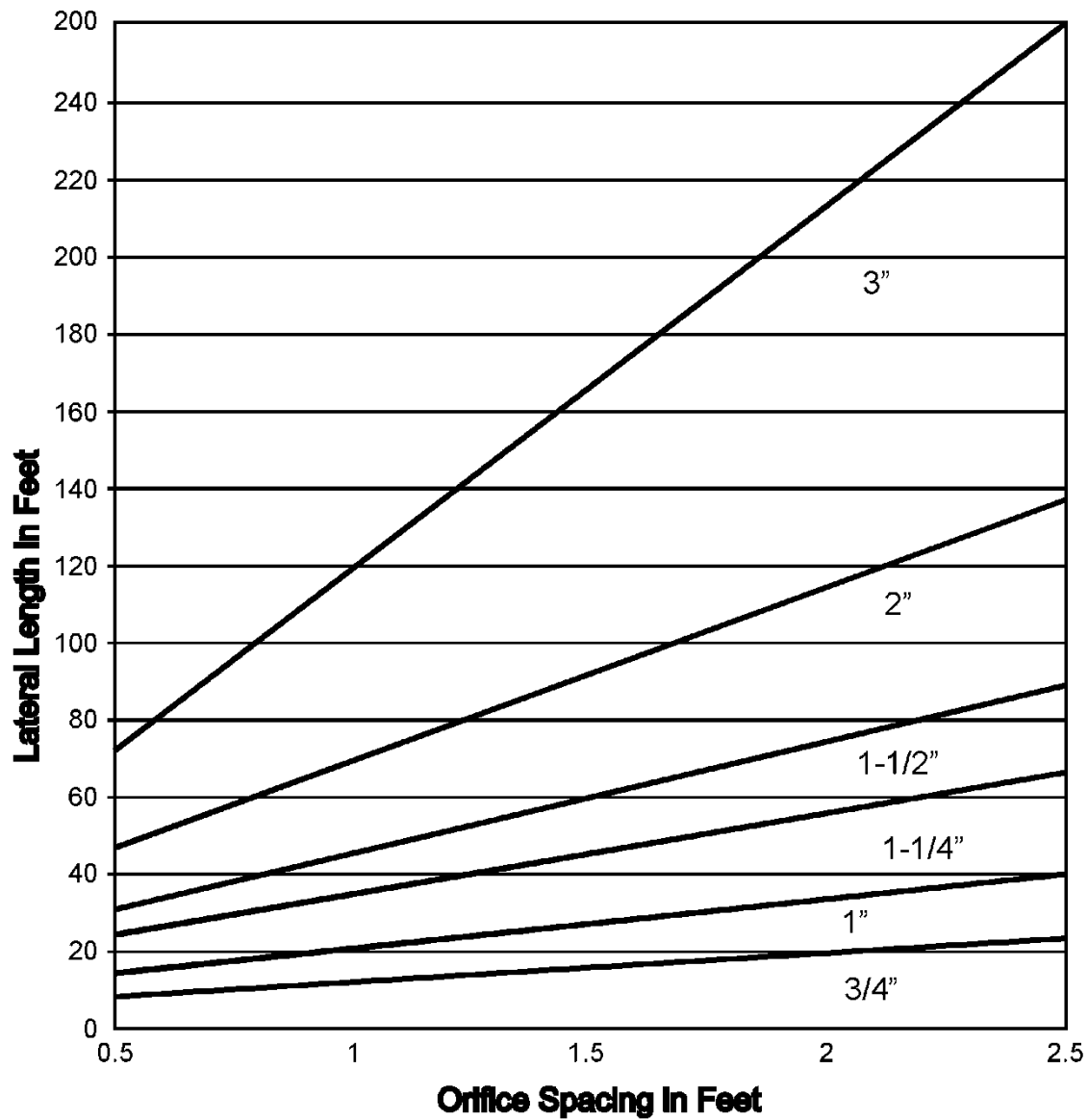

Fig. A-2a. Minimum lateral diameter based on orifice spacing for 5/32 in. diameter orifices (Wisc. Dept. Of Commerce, 1999)

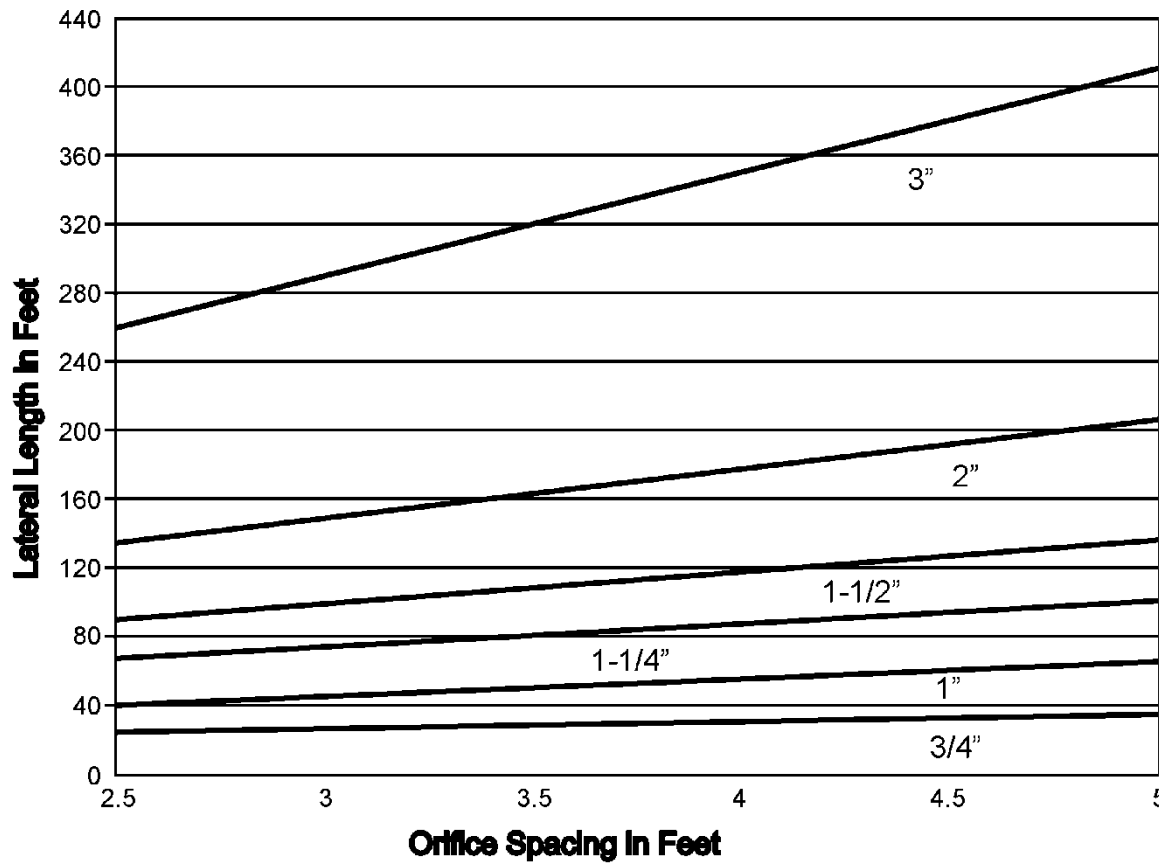

Fig. A-2b. Minimum lateral diameter based on orifice spacing for 5/32 in. diameter orifices (Wisc. Dept. Of Commerce, 1999)

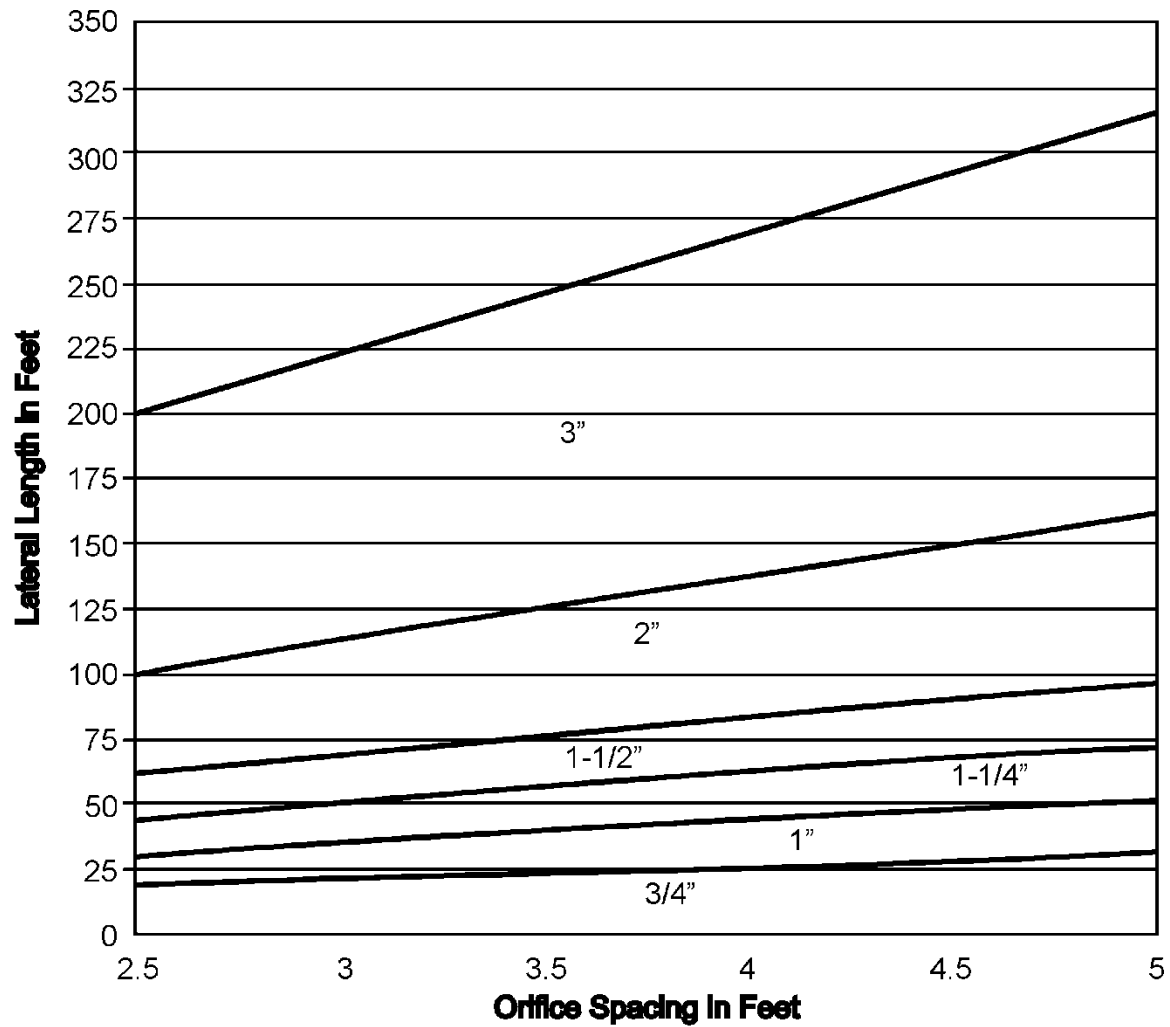

Fig. A-3a. Minimum lateral diameter based on orifice spacing for 3/16 in. diameter orifices (Wisc. Dept. Of Commerce, 1999)

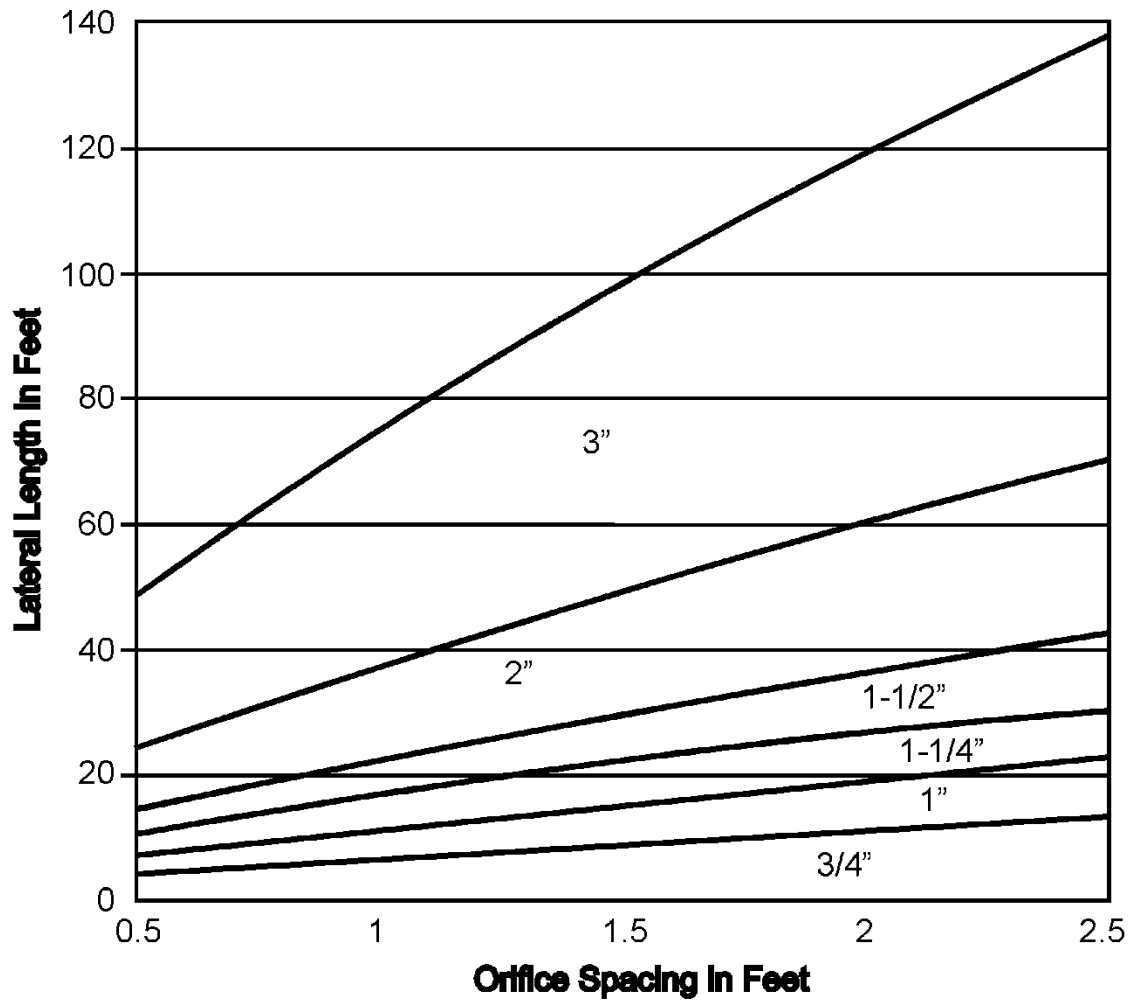

Fig. A-3b. Minimum lateral diameter based on orifice spacing for 3/16 in. diameter orifices (Wisc. Dept. Of Commerce, 1999)

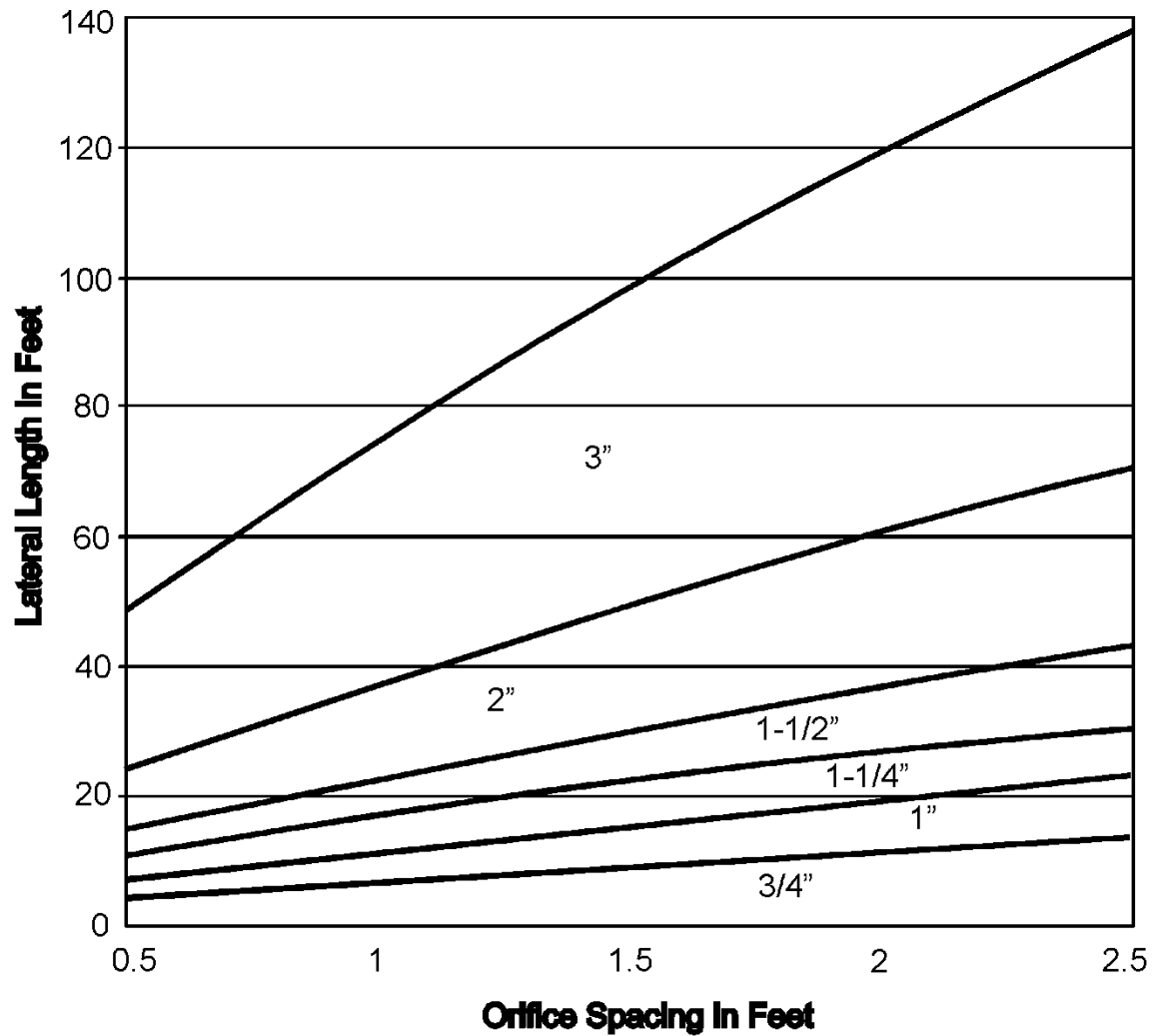

Fig. A-4a. Minimum lateral diameter based on orifice spacing for 1/4 in. diameter orifices (Wisc. Dept. Of Commerce, 1999)

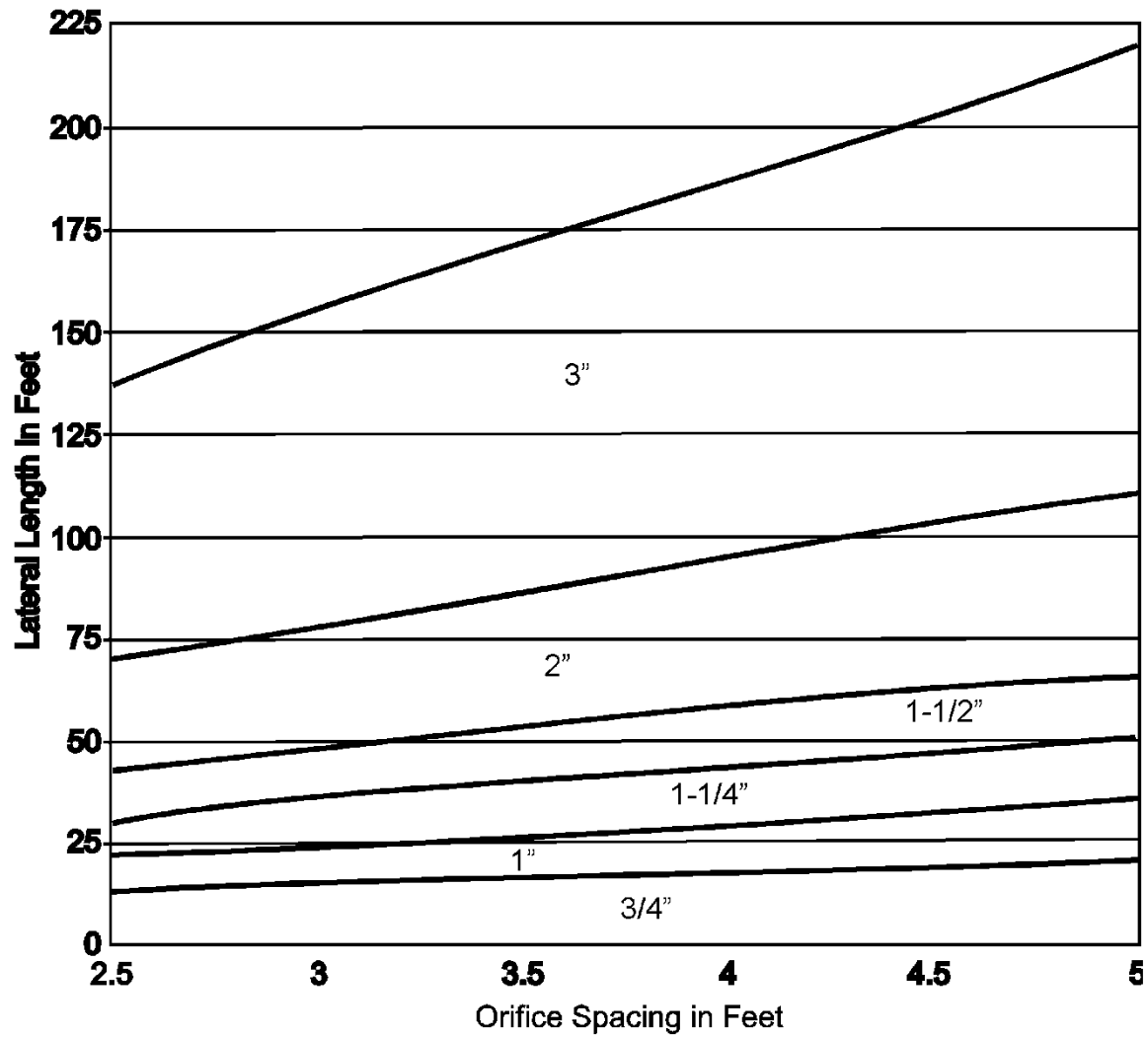

Fig. A-4b. Minimum lateral diameter based on orifice spacing for 1/4 in. diameter orifices (Wisc. Dept. Of Commerce, 1999)

**References:**

Converse, J.C. 1974 Distribution of domestic waste effluent in soil absorption beds. Trans. Of the ASAE. 17:299-304.

Converse, J. C. 1999. Septic tanks and pump chambers with emphasis on filters, risers, pumps surge capacity and time dosing. Small Scale Waste Management Project. 345 King Hall, University of Wisconsin-Madison, 1525 Linden Drive, Madison, WI 53706.

Converse, J.C. and E.J. Tyler. 2000. Wisconsin Mound Soil Absorption Systems, Siting, Design and Construction. Small Scale Waste Management Project. 345 King Hall, University of Wisconsin-Madison, 1525 Linden Drive, Madison, WI 53706. Publication No. 15.22.

Falkowski, G.M. and J.C. Converse. 1998. Siphon performance and pressure distribution for on-site systems. In. On-site Wastewater Treatment. Proceedings of the Fifth National Symposium on Individual and Small Community Sewage Systems. ASAE. Joseph, MI 49085.

Machmeier, R.E. and J.L Anderson. 1988. Flow distribution by gravity flow in perforated pipe. In. On-site Wastewater Treatment. Proceedings of the Fifth National Symposium on Individual and Small Community Sewage Systems. ASE. Joseph, MI 49085.

Otis, R.J. 1981. Design of pressure distribution networks for septic tank- soil absorption systems. Small Scale Waste Management Project. 345 King Hall, University of Wisconsin- Madison, 1525 Linden Drive, Madison, WI 53706. Publication No. 9.6.

Sump and Sewage Pump Manufacturers Association. 1998. Recommended guidelines for sizing effluent pumps. P.O. Box 647 Northbrook, Il 60065-0647.

Wisconsin Administrative Code. 1999. Pressure distribution component manual for private onsite wastewater treatment systems. Department of Commerce, Safety and Building Division, Madison, WI.

## SECTION O – APPENDIX 2

**2) Appendix 2 - Wisconsin Mound Design Example**

This example will follow steps to design a Wisconsin Mound. All requirements found in Section F, Absorption Field Methods, of the Manual must be followed.

*Design Example* – Evaluate the following soil profile and site conditions for a soil absorption system. Design an appropriate soil absorption system for the site.

Soil Profile - Summary of 3 soil pit evaluations.

0 - 6 in.	sil; 10YR 6/4 2/1; strong, moderate, angular blocky structure; friable consistence.
6 - 11 in.	sil; 10YR 5/3; moderate, fine platy structure; firm consistence.
11-20 in.	sic; 10YR6/3; moderate, fine, subangular blocky structure; firm consistence; few, medium, distinct mottles starting at 11".
20-36 in.	sic; 10YR5/3; massive structure; very firm consistence; many, medium, prominent mottles.

- Slope - 15%
- The area available consists of 180 ft long along the contour and 50 ft along the slope. There are 3 medium sized trees in the area.
- The establishment generates about 300 gallons of wastewater of domestic septic tank effluent quality per day based on meter readings.

1. *Evaluate the Quantity and Quality of Wastewater Generated.*

For all on-site systems a careful evaluation must be done on the quantity of wastewater generated. As indicated earlier, most code values have a built-in safety factor and includes peak flows. Thus, these values can be used directly in the design calculations. However, it is appropriate for the designer to assess if the establishment is typical for the code values assigned to it. If metered values are used, it is recommended to double the average daily flow rate for design purposes. However, the average flow rate should be based on a realistic period of time and not be, for example, an average of six months of very low daily flow rates and 6 months of very high flow rates. If that is the case, then the high flow rates should be used for design.

The quality of the wastewater must also be assessed. If it is typical domestic septic tank effluent, these sizing criteria may be used. However, if it is commercial septic tank effluent, lower soil loading rates are recommended (Siegrist, et al., 1985).

Design Loading Rate - 600 gpd.

2. *Evaluate the Soil Profile and Site Description for Design Linear Loading Rate and Soil Loading Rate.*

For this example and convenience the one soil profile description is representative of the site. A minimum of 3 evaluations must be done on the site. More may be required depending on the variability of the soil. The Soil Classifier must do as many borings as

required to assure that the evaluation is representative of the site. In evaluating this soil profile the following comments can be made:

The silt loam (A) horizon (0 - 6 in.) is relatively permeable because of its texture, structure and consistence. The effluent flow through this horizon should be primarily vertical.

The silt loam (E) horizon (6 - 11 in.) has a platy structure and strong consistence. The consistence will slow the flow up and the platy structure will impede vertical flow and cause the flow to move horizontally. However, if this layer is tilled, the platy structure will be rearranged and the flow will be primarily vertical. Thus, tillage must be done at least 12 in. on this site to rearrange the platy structure.

The silty clay loam (B) horizon (11 - 20 in.) is slowly permeable because of the texture and firm consistence. The flow will be a combination of vertical and horizontal in the upper portions and primarily horizontal flow in the lower portion of the horizon due to the nature of the next lower horizon. During wet weather the (B) horizon may be saturated with flow moving horizontally.

The silty clay (C) horizon (20 - 36 in.) will accept some vertical flow as the effluent moves down slope horizontally in the upper horizons. The flow through this profile will be similar to the profile shown in Figure 24.F.

Based on experience a properly designed mound system should function on this site. It meets the minimum site recommendations found in Table 5.F.

Linear Loading Rate:

Based on this soil profile and discussion under the Linear Loading Rate section, the linear loading rate must be in the range of 3 - 4 gpd/1f.

Linear Loading Rate = 4 gpd/1f.

Soil (Basal) Loading Rate:

A soil loading rate for the soil horizon in contact with the sand (basal area) is selected based on the surface horizon (A). Use Table 6.F to determine the design soil loading rate, which, for silt loam soil with moderate structure, is found under item (I), provided the platy structure is tilled.

Soil (Basal) Load Rate = 0.6 gpd/ft<sup>2</sup>

3. Select the Sand Fill Loading Rate.

The section entitled "Sand Fill Loading Rate" and Figure 26.F gives guidelines for selecting a suitable sand fill quality for the Wisconsin mound system. Other fills may be used but caution should be used as performance data is very limited with other fills.

Design Sand Loading Rate = 1.0 gpd/ft<sup>2</sup>

4. *Determine the Absorption Area Width (A).*

$$\begin{aligned} A &= \text{Linear Loading Rate} / \text{Sand Loading Rate} \\ &= 4 \text{ gpd/1f} / 1.0 \text{ gpd/ft}^2 \\ &= 4 \text{ ft} \end{aligned}$$

5. *Determine the Absorption Area Length (B).*

$$B = \text{Design Flow Rate} / \text{Linear Loading Rate}$$

$$= 600 \text{ gpd}/4\text{gpd}/1\text{f}$$

$$= 150 \text{ ft}$$

6. *Determine the Basal Width (A + I).*

The basal area required to absorb the effluent into the natural soil is based on the soil at the sand/soil interface and not on the lower horizons in the profile. An assessment of the lower horizons was done in step 2 when the linear loading rate was estimated. As discussed in Step 2, the soil (basal) loading rate is 0.6 gpd/ft<sup>2</sup>.

$$(A + I) = \text{Linear Loading rate} / \text{Soil Loading Rate}$$

$$= 4 \text{ gpd}/\text{ft} / 0.6 \text{ gpd}/\text{ft}^2$$

$$= 6.7 \text{ ft}$$

$$\text{Since } A = 4 \text{ ft}$$

$$I = 6.7' - 4' = 2.7 \text{ ft (will be larger due to mound side slope)}$$

7. *Determine Mound Fill Depth (D).*

Assuming the code requires 3 ft of suitable soil and soil profile indicates 11 in. of suitable soil then:

$$D = 36" - 11" = 25 \text{ in.}$$

8. *Determine Mound Fill Depth (E).*

For a 15% slope with the bottom of the absorption area level then:

$$E = D + 0.15 (A)$$

$$= 25" + 0.15 (48")$$

$$= 32 \text{ in.}$$

9. *Determine Mound Depths (F), (G), and (H).*

$$F = 9 \text{ in. (6 in. of aggregate, 2 in. for pipe, and 1 in. aggregate)}$$

$$G = 12 \text{ in. (6 in. in warmer climates)}$$

$$H = 18 \text{ in. (12 in. in warmer climates)}$$

10. *Determine the Upslope Width (J).*

Using the recommended mound side slope of 3:1 then:

$$J = 3 (D + F + G)$$

$$J = 3 (25" + 9" + 12")$$

$$= 11.5 \text{ ft.}$$

(Actual width will be less because of the site slope)

11. *Determine the End Slope Length (K).*

Using the recommended mound end slope of 3:1 then:

$$K = 3 ( (D+E)/2 + F + H )$$

$$= 3 ( (25" + 32")/2 + 9" + 18" )$$

$$= 14 \text{ ft.}$$

12. *Determine the Down Slope Width (I).*

Using the recommended mound side slope of 3:1 then:

$$\begin{aligned} I &= 3 (E + F + G) \\ &= 3 (32'' + 9'' + 12'') \\ &= 13 \text{ ft} \end{aligned}$$

(Actual width may be greater because of the site slope)

Note this value is greater than (I) in Step 6 and is the recommended width to use.

13. *Overall Length and Width (L + W).*

$$\begin{aligned} L &= B + 2K \\ &= 150' + 2 (14') \\ &= 178 \text{ ft.} \end{aligned}$$

$$\begin{aligned} W &= A + I + J \\ &= 4 + 13 + 12 \\ &= 29 \text{ ft} \end{aligned}$$

If this site was level, then  $I = J$ . For soil profiles allowing more vertical flow, the linear loading rate could approach 10 gpd/1f and the mound would be shorter and wider.

14. *Design a Pressure Distribution Network.*

A pressure distribution network system, including the distribution piping, dosing chamber and pump or siphons, must be designed (See Section O).

## SECTION O – APPENDIX 3

## 3) Appendix 3 - Inspecting Wisconsin Mound

By James C. Converse and E. Jerry Tyler

The Wisconsin mounds system was developed in the 1970s to overcome some soil site limitations for on-site disposal of septic tank effluent. A recent survey of Wisconsin counties found the mound system to be performing very well. However, the owner or inspector must identify potential problems early and diagnose them correctly, with a minimum of time and expense. This publication outlines potential problems, their symptoms, and solutions. It also presents a systematic method of inspecting and evaluating the system.

Below is a cross-section view of an entire system. To analyze problems, you must know the location of each portion of your system. Keep a scale drawing of your system handy.

The septic tank and dose chamber of the on-site system must be pumped periodically to remove accumulated solids. The tank and chamber should be pumped at least every 3 years in year-round residences. Seasonally used systems, e.g. in summer cottages and camps, require less frequent pumping.

Heavily used systems, e.g. in restaurants, require more frequent pumping. If you use one of these systems, work closely with an experienced hauler to establish a long-term pumping frequency to help minimize carry-over of solids to the soil absorption unit.

Conserve water when using a soil absorption system. Low-flow toilets, low-volume shower heads, front-loading washers, elimination of garbage grinders, and other techniques can reduce waste water with minimal inconvenience.

### Cross-section of a Wisconsin Mound System

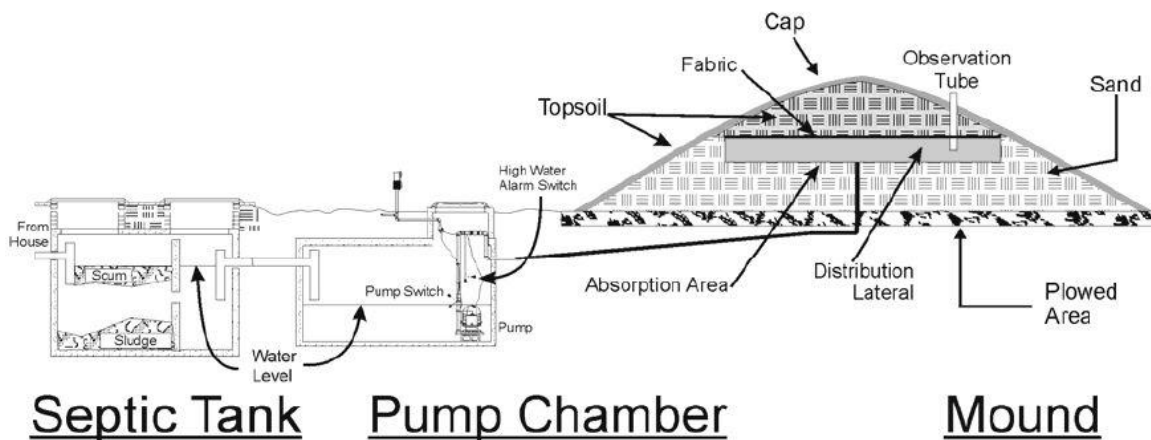

When you have completed inspecting and troubleshooting your Wisconsin mounds, all of the below questions should have been answered.

**Questions to be answered when inspecting a mound system.**

- |     |    |  |
|-----|----|--|
| Yes | No | 1. Is the alarm system operating properly?                         |
| Yes | No | 2. Does waste water ever back up into the house?                   |
| Yes | No | 3. Do the toilets ever flush slowly?                               |
| Yes | No | 4. Does the liquid level in the septic tank appear abnormal?       |
| Yes | No | 5. Is there a thick scum mat on the surface in the septic tank?    |
| Yes | No | 6. Is the liquid level in the dose chamber within operating range? |
| Yes | No | 7. Are there a lot of solids in the bottom of the dose chamber?    |
| Yes | No | 8. Is there standing water in the observation tubes in the mound?  |
| Yes | No | 9. Are there spongy spots on the top or side areas of the mound?   |
| Yes | No | 10. Is there seepage on the side slopes of the mound?              |
| Yes | No | 11. Are there spongy spots in the toe area of the mound?           |
| Yes | No | 12. Is there leakage at the toe of the mound?                      |

If you answered no to all of the questions, your mound system should be operating properly. If you answered yes to any of the questions, refer to the text for explanations, causes, and solutions.

**Warning: Do Not Enter the Tank or Chamber!!!**

**Never enter a septic tank or dose chamber without special equipment. People have died in septic tanks and dose chambers. They contain toxic gasses and little or no oxygen. Homeowners do not have the necessary equipment or the experience to safely enter tanks.**

Following is a list of symptoms, followed by an explanation of the problem, probable causes, and possible solutions. Make sure you investigate all possible causes before you attempt a repair.

Most of these solutions require an experienced plumber, installer or electrician. Most homeowners don't have the tools or expertise for this work. Untrained do-it-yourselfers may cause further damage and expense.

**SECTION O – APPENDIX 4****4) Appendix 4 - Troubleshooting Wisconsin Mound Systems****Symptom 1: Waste Water Backing Up at the House or Source**

Explanation: Toilets may flush very slowly; waste water may back up in the floor drain.

Causes: If the toilet flushes slowly, the roof vent may be frosted over. If waste water backs up in the floor drain and slowly seeps away, tree roots or accumulated solids may be clogging the sewer line to the septic tank. The restriction is often at the inlet to the septic tank. Over time, the blockage prevents waste-water flow from the house. The outlet from the septic tank to the dose chamber may be plugged; or the pump or controls may have failed, causing water to back up into the house.

Solution: Check the water level in the septic tank and dose chamber. If the dose chamber is full, the problem is a faulty control unit or pump or a blockage in the force main or mound. The alarm should have sounded. If not, check the alarm system. Inspect the circuit breaker. It may have tripped. If the liquid level is normal in the dose chamber, but higher than normal in the septic tank, the pipe connecting the septic tank and the dose chamber is plugged. Call a septic tank hauler or plumber to unplug the pipe and check the septic-tank baffles.

If the septic tank level is normal, the inlet to the septic tank or the pipe between the house and the septic tank is plugged. Take care when unplugging the inlet or the pipe.

**Symptom 2: Alarm from Dose Chamber**

Explanation: When the liquid level in the dose chamber reaches a set height above the wastewater level normally needed to activate the pump, it trips an audible alarm or light in the house.

Causes: Faulty pump or pump controls, or a malfunctioning alarm. Blockage in the force main or distribution system of the mound keeps the pump from moving water to the mound.

Solution: If the problem appears to be a faulty pump or controls, see Symptom 1. If the pump runs but the water level doesn't drop, then the force main or distribution laterals are plugged. See Symptom 10.

**Symptom 3: Excessive Solids Accumulating in the Dose Chamber**

Explanation: Settled solids should be removed in the septic tank. Solids carried to the dose chamber will be pumped to the mound and may plug the distribution system or the mound infiltrative surface.

Causes: Not pumping the septic tank often enough. Broken baffles in septic tank. Excessive solids introduced into the system.

Solutions: Pump the septic tank on a regular basis and have baffles checked after

each pumping. Don't use in-sink garbage grinders. They add too many solids to the septic tank.

#### Symptom 4: Ponding in the Absorption Area of the Mound

Explanation: If you see waste water in the observation tubes (Figure 25.F) you have ponding at the sand/aggregate interface. It may be 1) ponding during dosing, 2) seasonal ponding, or 3) permanent ponding.

Ponding during dosing is very temporary and usually disappears shortly after the pump stops. Seasonal ponding occurs over the winter but usually disappears by early summer. Low bacterial activity allows a clogging layer to develop at the sand/aggregate interface, which reduces the infiltration rate across the interface. As the weather warms, bacterial activity increases, reducing the clogging mat and increasing the infiltration rate. Seasonal ponding rarely causes problems.

Although not itself a failure, permanent ponding (waste water always visible in the observation tubes) may lead to failure.

Causes: Permanent ponding is the result of a clogging mat at the sand/aggregate interface. It may be caused by overloading of septic tank effluent and/or too fine a sand fill.

Solutions: Check the observation tubes every 3 months to see if permanent ponding is occurring in the mound's absorption area. If the ponding appears to be permanent, reduce water use in your home to reduce the load to the system. This often reduces permanent ponding.

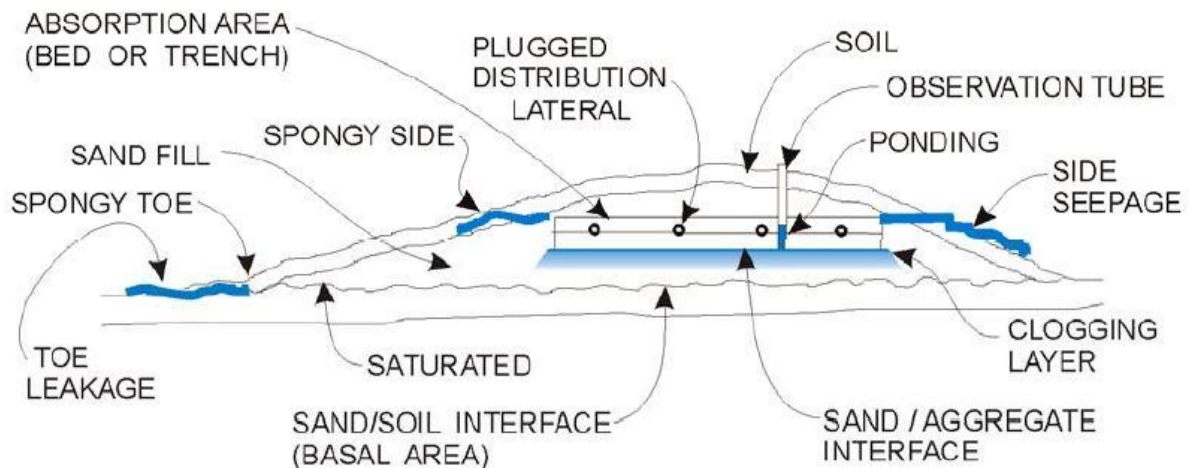

#### Symptom 5: Seepage Out the Side of the Mound

Explanation: Seepage out the side of the mound is usually black and smelly. It is primarily septic tank effluent that has been pumped into the mound. The breakout normally occurs around an observation tube or at other locations near the top of the mound. The effluent flows down the side of the mound (as shown in above figure).

Causes: A clogging mat prevents effluent from infiltrating into the sand as quickly as it's pumped into the mound. Effluent is then forced to the surface of the mound. The clogging mat appears as a black layer at the sand/aggregate interface. The sand several inches below the interface is usually dry and clean.

Temporary or continuous overloading also causes seepage out the side of the mound, even though a clogging mat may not be causing permanent ponding.

Solutions: Estimate the effluent entering the system. Look for 1) excessive water use in the home, and 2) groundwater entering the dose chamber. Reduce the loading to the mound by conserving water in the home and/or eliminating infiltration through joints in the riser into the dose chamber. To eliminate infiltration, re-caulk all the joints on the outside of the riser including the joint between the riser and the tank cover.

Determine the quality of fill. Sample the sand at several locations and have it analyzed for particle size. (Some experienced people can estimate sand texture in the field.) If the sand beneath the absorption area is fine sand, medium sand with a lot of fines in it, or coarse sand containing a lot of fine and very fine sand plus silt and clay, the mound may have to be partially rebuilt.

To partially rebuild the mound:

- 1) remove the soil above the absorption area,
- 2) remove the distribution system and aggregate,
- 3) remove the sand beneath the absorption area down to the natural soil,
- 4) replace it with an approved sand fill,
- 5) replace the distribution system,
- 6) cover with a synthetic fabric,
- 7) replace, seed and mulch the topsoil.

Another approach may be to lengthen the mound, if you have the space:

- 1) remove the topsoil on the end slope,
- 2) till the natural soil,
- 3) place the proper-quality sand fill,
- 4) place the aggregate in the absorption area and extend the laterals,
- 5) place fabric on the aggregate,
- 6) place topsoil on the mound extension,
- 7) seed and mulch.

Note that making the absorption area wider may cause leakage, especially on slowly permeable soils. Prior to extending the mound, determine if pump or siphon will provide sufficient head at the end of the distribution laterals.

### **Symptom 6: Spongy Area on the Side or Top of Mound**

Explanation: A small amount of effluent seepage from the absorption area may cause soft spongy areas on the side or top of the mound.

Causes: Spongy areas indicate ponding in the absorption area—the result of nearly saturated soil materials.

Solutions: See Symptom 5. Spongy areas usually precede seepage.

### **Symptom 7: Leakage at the Toe of the Mound**

Explanation: Effluent leakage at the toe of the mound may be seasonal or permanent. Extremely wet weather can saturate the toe area, causing leakage. Leakage usually stops a few days after the wet period. In extreme cases the toe may leak continuously, even during dry weather. Research has shown that the water is of high quality with no odor and few if any fecal bacteria. This leakage is often indistinguishable from natural surface water.

Causes: Leakage at the toe may be caused by 1) overloading of the mound due to excessive water use or groundwater infiltration, 2) overestimating the infiltration rate and hydraulic conductivity of the natural soil during design, 3) hydrophobic soils that do not readily accept water, and 4) soil compaction during construction.

Solutions: Conserve water to add less waste water to the system. If the soil accepts the waste water, but more slowly than anticipated, extending the toe sometimes eliminates the leakage.

To extend the toe:

1) remove the existing toe, 2) allow the soil to dry, 3) till downslope soil area, 4) place sand on the tilled area, 5) place topsoil over the sand, 6) seed and mulch the topsoil.

If the natural soil beneath the mound is dry even though the sand fill above is saturated, the natural soil is hydrophobic, compacted or accepts the waste water very slowly. The waste water is moving horizontally at the sand/soil interface, rather than downward.

Extending the basal area downslope may help. You may also have to increase the length of the mound. This reduces the linear loading rate and reduces the loading at the toe. A combination of both may be required.

In extreme situations, place an interceptor drain at the downslope toe to move leakage away from the toe of the mound to a drainage ditch. Many states prohibit surface disposal of this water, so this approach may not be feasible.

If you know that groundwater is moving laterally downslope on sloping sites, place an interceptor drain on the upslope edge of the mound to intercept the groundwater. This allows the effluent to infiltrate into the soil and replace the intercepted groundwater.

### **Symptom 8: Spongy Area at the Toe of the Mound**

Explanation: Saturated sand fill and nearly saturated cover soil at the toe makes it soft and spongy.

Causes: Causes are similar to those of Symptom 7, though not as extreme.

Solutions: Same as Symptom 7.

### **Symptom 9: Too Much Effluent Flows Back into the Dose Chamber after the Pump Shuts Off.**

Explanation: The pump pressurizes the absorption area by forcing effluent into the aggregate and soil above the distribution laterals. When the pump shuts off, the effluent flows back into the dose chamber until the effluent level in the absorption area is below the distribution laterals. Side seepage may or may not occur.

Causes: Permanent ponding fills the aggregate below the laterals. Verify this by checking for effluent in the observation wells. Rapidly overloading the system may also cause excessive flowback.

Solutions: Same as Symptom 5.

### **Symptom 10: The Pump Runs Continuously with No Drop in the Liquid Level in the Dose Tank.**

Explanation: The observation tubes indicate that the absorption area is not ponded, but the mound does not accept waste water satisfactorily.

Causes: Solids plug the small-diameter holes in the distribution system, and effluent can't flow into the absorption area. Items such as disposable wash towelettes or sanitary napkins will not settle out in the septic tank and are carried over into the dose chamber and forced into the distribution pipes.

Solutions: Pump septic tank and dose chamber. (Every 3 years for residential units; more often for heavily used systems.)

Do not flush towelettes and similar materials down the toilets.

If system is plugged, remove the end caps to the distribution lateral and sand flush out the solids using a high-volume, high-pressure pump. Recap the laterals and force water or air into the distribution system to unplug the holes. Septic tank pumpers, when pressurized, force water into the laterals to remove the accumulated solids and force water out the holes to unplug them.

Consider installing a 1/8-inch screen around the pump or siphon to keep larger solids out of the system. Other types of filters may also minimize the solids carried over to the dose tank.

### **Symptom 11: Occasional Septic Odors**

**Explanation:** Biological activity in the septic tank and dose chamber produces ammonia, hydrogen sulfide and other foul-smelling gases. These gases escape from the dose tank via the vent and possibly the house vent stack.

**Causes:** Odors generated in the septic tank and dose chamber can circulate to occupied areas under certain humidity and wind conditions.

**Solution:** There is no easy solution to this problem, because the odors are usually emitted through the vent of the dose chamber. Extending the dose chamber vent to roof level may minimize these unpleasant odors. If the dose chamber is vented back through the septic tank and house stack, you may be able to plug the dose tank vent during warm weather. Occasionally the odors may be caused by gases emitted through the house stack. In this case, nothing can be done.

**References:**

Converse, J. C. and E. J. Tyler, 1986. Wisconsin Mound Performance, Small Scale Waste-Management Project, College of Agricultural and Life Sciences, 240 Agriculture Hall, University of Wisconsin-Madison.

**Symptoms, probable causes and solution index.**

<b>Inspection Point</b>	<b>Symptom</b>	<b>Probable Cause</b>	<b>Symptom #</b>
1. Alarm	sounding	pump failure alarm switch failure	2
	non-functioning	circuit breaker thrown faulty alarm 2	2
2. Floor drain	waste on floor	house sewer plugged septic tank inlet plugged septic tank outlet plugged pump failed distribution laterals plugged	1, 2, 10
3. Septic tank	liquid waste level above normal	outlet plugged pump failed distribution laterals plugged	2,10
	excess solids	excess solids added garbage disposal	3
4. Dose chamber	liquid level above high-water pump switch	pump failure control failure plugged laterals	9, 10
	excess solids	solids carry-over septic tank baffle missing	3
	groundwater inflow	high groundwater leaky joints	5
	odors	pump chamber emitting odors	11
5. Mound	water in observation tubes	soil absorption area plugged excessive water use	4
	seepage of raw sewage on side or top of mound	soil absorption area plugged system overloaded sand fill too fine	4
	spongy on side and top of mound	same as seepage of raw sewage (above)	5
	leakage at toe	slowly permeable soil compaction during construction soil damaged during construction overloading of system	6
	spongy at toe	same as leakage at toe (above)	7

University of Wisconsin-Extension, Cooperative Extension Service, in cooperation with the U.S. Department of Agriculture and Wisconsin counties publishes this information to further the purpose of the May 8 and June 30, 1914 Acts of Congress; and provides equal opportunities in employment and programming including Title IX requirements.

Produced by the Department of Agricultural Journalism, University of Wisconsin-Madison.

This publication is available from your Wisconsin county Extension office or from: Agricultural Bulletin, Rm. 245 30 N. Murray St. Madison, Wisconsin 53715 Phone 608-262-3346

Editors, before publicizing, contact Agricultural Bulletin to determine availability.

James C Converse is professor, Department of Agricultural Engineering, University of Wisconsin-Madison. E. Jerry Tyler is associate professor, Wisconsin Geological and Natural History and Department of Soil Science, University of Wisconsin-Madison.

## SECTION O – APPENDIX 5

## 5) Appendix 5 - Pathogenic Microorganisms in Domestic Wastewater and the Diseases They Cause

Microorganism	Disease(s) Caused
<b>BACTERIA:</b>	
Salmonella species	Typhoid, paratyphoid, gastroenteritis
Shigella	Bacillary dysentery
Yersinia	Gastroenteritis
Mycobacterium	Tuberculosis
Leptospira	Leptospirosis
Campylobacter jejuni	Gastroenteritis
Pathogenic coliforms (e.g. E. coli)	Gastroenteritis, urinary tract infections
Yersinia enterocolitica	Gastroenteritis
Pseudomonas	Respiratory and burn infections, diarrhea
Klebsiella	Pneumonia, bronchitis
Serratia	Respiratory and urinary tract infections, summer diarrhea
<b>VIRUSES:</b>	
polioviruse	Poliomyelitis
hepatitis A	Infectious hepatitis
echoviruses	Respiratory disease, aseptic meningitis, diarrhea, fever
Coxackie viruses	Respiratory disease, aseptic meningitis, myocarditis
noroviruses	Gastroenteritis
rotaviruses	Gastroenteritis
adenoviruses	Respiratory disease, eye infections
<b>PARASITES:</b>	
Entamoeba histolytica	Amoebic dysentery
Giardia lamblia	Giardiasis (“backpacker’s diarrhea”)
Balantidium coli	Dysentery, gastroenteriti
Ascaris ova	Pneumonitis, intestinal and nervous system disorders
Trichuris	Chronic gastroenteriti
Enterobius vermicularis	Enterobaisis
Cestode ova	Chronic gastroenteriti
Coccidia	Diarrhea, toxoplasmosis

\* (Adapted from Kreissl, 1983, Fitzgerald, 1983, and sobsey, 1983a)

**SECTION O – APPENDIX 6****6) Appendix 6 - Septic Tank System Failure**

April 1997

Ade O. Oke, Rem

Principal Engineer

Georgia Department of Public Health

**About the Author**

Ade O. Oke is a registered environmental manager, qualified by the National Registry of Environmental Professionals. He has earned B.S.Ch.E. and M.S. degrees in Chemical engineering from the University of Mississippi, University, Mississippi. He also has earned a M.S.O.R. degree in Operations Research from the School of Industrial and Systems Engineering, Georgia Institute of Technology, Atlanta, Georgia.

Ade Oke has been a Principal Engineer for the Georgia Public Health Division since July 1988. Prior to his joining the Georgia Public Health division, Ade worked as an engineer for Royal Dutch/Shell Company, headquartered at Hague, Netherlands. At present, Ade is managing the Georgia on-site sewage management program.

**Synopsis**

It is well known fact that wastewater disposal, when done improperly, can pose a threat to the environment and public health. In order to protect people and environment, wastewater must be well disposed of in a manner that controls waterborne diseases and prevents contamination of surface water and underground water. It is the aim of this document to:

- Enhance public health protection, and
- Provide public health professionals, engineers, scientists, environmentalists, septic tank installers and pumpers, and others with first hand knowledge to make competent decisions whenever a septic tank system fails.

It must be noted that this document is not a panacea for all septic tank system problems. It is only an aid to solving some of the problems.

**Acknowledgements**

I would like to express my appreciation to LaTonya-Blount for her help in making this document possible. All county environmental health specialists in the State of Georgia are gratefully acknowledged for all their efforts, energy and self-motivation.

**Disclaimer!!** Mention of trade names or commercial products do not constitute endorsement by the author. Moreover, the views expressed herein are entirely the author's and do not represent the official policy of the Georgia Department of Public Health.

## TABLE OF CONTENTS

### Part I Introduction

Why Use a Septic Tank System?

How does a Septic Tank System Work?

What Septic Tank System Design Practices Are Improper?

What Are the Signs of a Failing Septic tank System?

### Part II Rehabilitating a Failing Septic Tank System

Section A Problem Identification

Section B Taking Corrective Action

### Part III References

## PART I

### Introduction

In the State of Georgia, over 30,000 new septic tank systems are installed each year for new housing, commercial and industrial development adding to over 600,000 systems that are already in use. These systems contribute over 75 million gallons of wastewater into the environment every day. Most of these systems function satisfactorily, but approximately 10,000 systems are repaired each year because of failure. Accordingly, the system failures and installation of septic tank systems on unsuitable sites can create serious threats to public health and significant economic impact. Properly designed and located septic tank systems are now a permanent means of wastewater disposal that can function reliably with minimum maintenance and cost.

### Why Use a Septic Tank System?

The septic tank system is an effective method for collecting, treating and disposing of sewage mostly from rural and suburban homes. In other words, whenever the municipal or community sewage treatment plants are inaccessible, the septic tank system is used. It is an on-site sewage management system designed to safely treat and dispose of wastewater from toilet, shower, bathtub, handwash sink, kitchen, and laundry. This wastewater usually contains disease causing germs and pollutants that must be treated to protect human health and the environment.

### How Does a Septic Tank System Work?

Wastewater from the home is collected in a water-tight tank called a septic tank. Bacterial action takes place in the septic tank where the end products are mainly water (mixed with some other components that are not readily consumed by bacterial action). Gases and undigested material called sludge that sinks to the bottom of the tank and scum that floats to the top of the tank.

The septic tank contains a baffle that prevents any scum that floats to the surface and sludge that settles to the bottom from passing out of the tank. The gases that are generated vent to the atmosphere via the plumbing vent.

The segregated and relatively clear liquid in the tank will fill the outlet level, which is located on the opposite side of the tank from the inlet. As wastewater enters the tank, an equal volume of the liquid flows from the septic tank through the outlet into a small distribution box where it is then metered out to several perforated pipes or some other disposal system. These perforated pipes then deliver the liquid to a large subsurface area called the drainfield, nitrification field or soil absorption field.

The major function of the drainfield is to deliver the effluent to the soil. The soil purifies the effluent by removing the germs, solids and chemicals that may be carried along with the effluent before they reach the groundwater.

### **What Septic Tank System Design Practices Are Improper?**

Many of the problems of septic tank system result from Improper design procedures which can be avoided. Some of these procedures include:

- relying solely on published soils information from the local county soil survey rather than performing actual field tests at the site.
- poor site evaluations, including failure to-assess impacts of surface runoff and internal groundwater movement,
- poor soil profile description made by nonqualified personnel who fail to detect seasonal high water tables and who fail to locate and properly describe restrictive features, e.g., slowly permeable layers and fractured rock,
- failure to design treatment units and absorption system for long-term performance. Systems are designed typically by using State Regulations and Codes as the sole basis of design; these guidelines are often only meant to serve as guidelines for establishing minimum requirements,
- failure to correlate soil characteristics with permeability test results,
- failure of designers to fully adapt a wastewater system to the site. Errors are made with mismatching absorption system geometry with site conditions which often result in localized overloading of the soil and possible groundwater mounding and flooding.
- improper installation of the system in an area not previously tested or with insufficient separation from water supplies such as wells, springs or other water ways,
- designers sometimes fail to understand the impact of soil characteristics relating to installation. Such potential problems during installation include:
  - installation at a less-preferred location than designed (e.g., a location with
  - concave slopes).
  - excessive deep installation of any soil absorption system,
  - high soil moisture during installation,
  - backfilling causing damage to pipes, tanks, or other buried structure
  - compaction of soil in and around the down slope area, once the pipes or tanks are in place,
  - not adhering to specifications such as placement of coarse material beneath pipes or tanks, or leveling of in-ground facilities,

- site damage following preliminary evaluation and design (e.g., soil removal, compaction),
- inadequate depths or protection to avoid freezing in-ground facilities,
- lack of field testing following installation but prior to the contractor leaving the site (e.g., pressure testing pumps and siphons or water testing a level distribution box), or
- insufficient diversion of runoff to avoid infiltration and possible hydraulic overloading.
- failure of designers to consider techniques which can be implemented in the field to make gravity-feed systems perform better (e.g., specifying discharge hole diameters and spacing for wastewater distribution network),
- improper siting (e.g., up slope of a water supply well or within poorly drained soil), or
- failure to project flow inputs for the life of the proposed facility.

### **What are the Signs of a Failing Septic Tank System?**

Unfortunately, it is not uncommon to find a septic tank system that is failing. In most cases, the failure starts as a small problem and continues growing until the problem is too large to ignore.

The signs of a failing system include:

- Surfacing or ponding of the septic tank effluent on the ground surface. This effluent may contain many disease-causing bacteria, viruses, and dysentery, hepatitis, giardiasis, cryptosporidiosis, hookworm, tapeworm and other diseases that have plagued mankind for years. Children are most likely to play in the pools or wet soil, but adults may have to walk through or work in the area, and once the effluent gets on a person, the germs can spread to the mouth or nose where they are swallowed or inhaled.
- Slow drains or sewage backing up into the house. The cause could be from failure or any part of the system.
- Smell of sewage odor outside the house where drainfield is not saturated and there is no back-up. This may cause fly infestations and isolated outbreaks of water-borne diseases.

## **PART II**

### **Rehabilitating a Failing Septic Tank System**

Source: State of North Carolina On-Site Wastewater Management Guidance **Manual**

#### **Problem Identification**

Whenever a septic tank system fails, the key to rehabilitation of the system is to use a systematic approach to identify the problem. The basic idea is to check the easy things first and then go to the more difficult items. The following steps are used to determine why a septic system is failing.

1. Determine the type of failure

The type of failure can indicate, to a large extent, what is causing the problem. To properly determine the type of failure, a field inspection must be done.

- Surface discharges can indicate which part of the system is failing. Note where the discharge is and appears to be coming from. Is the discharge:
  - over the septic tank?
  - over the pump tank?
  - over the distribution box?
  - over the treatment or disposal field? What part of the field?
  - Are drains backing up into the house?
- Do fixtures in the house drain slowly?
- Is the problem occurring only in the wet season, after heavy rains,
- or throughout the year?
- Does the problem occur only on weekends, or every day?
- Is the effluent flowing at the failure site or is it a small wet spot that soaks back into the ground?
- Has the system operated well for a number of years and failed just recently, or has it been failing for a long time?

## 2. Check the easy things first

The cause of the septic tank system failure often can be determined easily without complicated tests. Some failures may mean that complicated tests must be done, but many problems can be solved by checking the easy things.

- If the water is backing up into the house or the toilets are flushing slowly, check for clogged plumbing first. A clog in the drain or house sewer going to the septic tank may be the problem.
- Plugged plumbing vents, located on the roof of the house, also cause slow drains. Once the vent pipes are cleared, it may be helpful to put a screen over the vent pipe to keep out insects, rodents and birds.
- If the house drains and roof vents are not plugged, check the septic tank. Uncover the access hatches and check for a clogged inlet or outlet.
- If the inlet is clogged with solids, the house sewer coming into the tank may need a larger pipe or may have collapsed and need replacing.
- A clogged outlet may mean that the outlet has broken or that the solids need to be pumped out. If the tank is completely full of solids and scum, it must be pumped. The residents must be informed that septic tanks should be pumped on a regular schedule. Pumping the tank keeps it from plugging and protects the treatment and disposal field from clogging with solids.
- Distribution boxes can also be easily checked. Uncover the distribution box and check for clogs and excessive solids in the box and for unequal distribution of flow to the outlets.
- Check to see if the distribution box is out of level. Re-level as needed.
- Distribution boxes can help determine which part of the system is having the problem.
- Clear water flowing through the distribution box may indicate leaking fixtures and excessive water use.

- Solids in the distribution box mean that the septic tank outlet is not keeping the solids in the tank or that the tank is too full of solids and needs to be pumped.
- If no effluent is flowing to the distribution box, then there is a clog in the conveyance pipe to the distribution box, in the septic tank, or in the house plumbing.
- If the box is flooded, the effluent is not flowing out of the box to the drainfield, indicating the problem is either in the conveyance pipes going to the drainfield or in the drainfield.
- In systems that pump to drainfield, check to see if the pump is working.

If these quick checks do not indicate what the problem is, then the following may help determine why the septic tank system is failing.

### 3. Determine the sewage volume

The volume or total daily flow of sewage going to a system can cause it to fail if the system was designed for a smaller flow.

- Find the original design flow or expected daily flow of sewage. This information should be on the permit or other approval forms.
- There are several ways to find the actual flow into the septic tank system. An easy way is to check the water bills for records of water used. This is a good indication of how much water is going into the septic tank system unless there is a leak that drains somewhere else, such as under the house.
- If the water bills do not help, keep a record of the water meter reading over a period of time, say a month or two. If you are keeping records of the water meter reading, be sure that the plumbing is not leaking into the ground outside the house. Water from a leak outside the house will not go into the septic tank system.
- The water meter should be checked as frequently as possible; once each day may be necessary. If the water meter is a dial or pointer that indicates small volumes, see if it turns when no water is being used. This is a sure sign of a leak.
- Study the records of water use to find if there has been an increase in flow to the system. Leaking faucets and toilets can add large amounts of water to the daily flow of sewage, causing the septic system to fail.
- Has a water-using appliance be installed or added to the household recently? A system that was not designed for high flows may fail when a washing machine or dishwasher is added.
- Has the water use habits in the home changed? A new baby can greatly increase the amount of water used in washing clothes, or teenagers can spend long amounts of time in-showers, which increases the total sewage flow.
- Have the residents changed the use of the washing machine? Are they washing clothes once per day when they used to wash once per week? Sometimes a septic system fails if the residents take in additional washing or if they wash all of their laundry on one day of the week. The residents can try washing one load each day, as opposed to all loads in one day.
- Has the use of the home changed? For instance, has a business that uses large quantities of water been started? Businesses such as day care centers, beauty shops and hobbies such as photography processing can cause problems.
- Has water been added to the daily sewage flow in other ways? Examples are:

- Sump pump installation which discharges into sanitary drain,
- Roof runoff from downspouts connected to sanitary drains,
- Foundation drainage flowing into sanitary drain,
- Heat pump discharging ground water into sanitary drain,
- Water softener recharge brine flows into septic tank,
- Swimming pool filter backwash water discharged into septic tank,
- Ice machine adds to daily sewage flow,
- Industrial wastewater added to domestic wastewater flow, and
- Floor drains adding water to daily sewage flow.

#### 4. Check topographic and landscape factors

A number of features of the land can cause a septic tank system to fail.

- Study the topographic position of the failing system. Is it at the base of a hill where surface drainage from the hill could flow onto the drainfield area? On long slopes, water can flow several hundred feet through the soil and flood the drainfield area.
- Is the drainfield downstream from a large drainage area where water drains onto it?
- Do roadside ditches, swales, or other channels drain water onto the drainfield?
- Does ground water flow into the drainfield or does the water table rise in wet weather, causing a failure?

#### 5. Investigate the septic tank

Determine if the septic tank is causing the problem.

- Inspect the septic tank inlet. Check the inlet to see if it is clogged and make sure sewage is flowing to the septic tank. A clogged inlet or crushed inlet pipe will cause sewage to back up into the house.
- Inspect the septic tank outlet. Is the outlet broken or clogged?
- Is the outlet working properly, holding back the solids, grease, and scum? Measure the depth of the scum layer and the solids to see if either is flowing into the outlet.
- If the outlet is full of solids and grease because too many solids and too much grease have accumulated in the tank, then the tank must be pumped out.
- Check the depth to the top of the tank. If the tank is too deep, the effluent may have to flow uphill to reach the drainfield, causing the sewage to back up in the septic tank. This problem occurs only in new systems; if the system has worked for a number of years, this condition should not be present.

#### 6. Find the drainfield trenches and determine the amount of ponding.

Many septic tank systems failures occur because the drainfield is not handling the effluent properly.

- Do not dig an open hole in a trench and leave it open. Open holes can spread bacteria and disease.

- Observation tubes can be installed to check the water level in the trenches. These tubes are vertical, open-ended pipes with one end in the trench and the other end sticking above the ground and covered by a removable cap. By removing the cap and looking or measuring down the observation tube, the water level in the trench can be easily observed and measured. By measuring the depth of water and how long the water stays in the trench, you can get an idea of whether the trenches are clogged.
- If the water level in the trench rises quickly and drops rapidly, the trenches are not clogged. The drainfield is being overdosed with effluent and some of the effluent is ponding.
- If the water level rises quickly and drops very slowly or continues to rise, then the trenches are clogged and will need to be repaired or replaced.
- Use the observation tubes to determine if the trenches are flooded permanently or only temporarily.
- If effluent is ponding on the ground surface, find out if the ponding is permanent or if it only happens during wet periods, after heavy use, during certain days of the week, etc.
- Is one part of the drainfield being overloaded? A distribution box that has shifted may direct all the effluent to one trench.
- Look for changes in the soil across the drainfield especially for soil types that cannot absorb much effluent.
- Are the trenches too deep? Have the trenches been installed below the seasonal high water table? Is there a perched water table under the drainfield that may restrict the flow of effluent away from the trenches?
- Have the trenches been installed so that they run up a hill or are not on the contour? Is there too much fall on the trenches so that the effluent runs to the end of the trenches?
- In areas with very uneven ground, be sure that the trenches have been placed deep enough so that the trench is not too shallow in low spots.
- If effluent is surfacing somewhere other than over the drainfield, it may mean that an utility trench has been cut across the drainfield. Effluent flows through the loose backfill in underground electrical, cable TV, telephone or water lines, and surfaces in a low spot along utility trenches. The utility trench should be moved so that it does not cross the drainfield.

#### 7. Determine the rate of absorption of wastewater by the soil.

A method to determine the absorption rate of the soil in the trenches is presented below. This technique is useful because it gives a value of the treatment and disposal rate for the trenches as they really are. Once the treatment and disposal rate has been found, you can better understand why the system is failing.

- A. Determine the daily usage of water by reading the water meter. Take readings for at least a week or longer to be sure that you have a good idea of the amount of water being used.
- B. Install observation tubes in the trenches.
- C. To begin the test, mark the level of water in the trenches as seen through the observation tubes.
- D. Use no water in the house for at least eight hours. The water at the meter should be turned off so that the residents will not use the water.
- E. Read the water meter after it has been turned off. This reading will be used to find how much water can be absorbed by the system over the eight hour period.

- F. Watch the water level in the trenches drop over the eight hour period. At the end of the eight hour period, measure the level of water in the trenches.
- G. Turn the water on and let the water flow so that the trenches fill to the same level as at the beginning of the eight-hour period. When the trenches have filled to the level at the beginning of the test, turn off the water at the faucet and read the water meter.
- H. Subtract the water meter reading at the beginning of the eight hour test from the meter reading at the end of the test to find the total volume of water used to fill the trench back to the water level at the beginning of the test. This volume of water is also the volume of water absorbed in eight hours.
- I. Take the volume of water absorbed in eight hours and multiply it by three to get the volume of wastewater absorbed in one day.
- J. If the rate of wastewater treatment and disposal per day, through the soil, is less than the amount of water used per day, then the system is being overloaded. Determine the percentage that the system is overloaded using the following equation:

$$\text{Percent overloaded} = \frac{\text{GPD use} - \text{GPD Wastewater absorbed} \times 100}{\text{GPD Wastewater absorbed}}$$

- If the system is less than 35% overloaded, then the residents may be able to correct the system failure by water conservation. Water conservation includes using low-flow showerheads, low-flush toilets, flow restrictors on all faucets, and other methods to reduce the volume of water flowing to the septic tank system. Installation of these devices is much cheaper than rebuilding a septic tank system.
- If the plumbing system has a pressure-regulating valve, the pressure in the house can be reduced somewhat, which will help lower water usage. On drinking water well systems, the pressure switch for the well pump can be set to operate over a cycle of 30 to 50 psi rather than the usual 40 to 60 psi setting.
- The residents can lower their water use by a number of simple actions. Shutting off the water while shaving or brushing teeth, taking short showers, and taking laundry to a Laundromat are all ways to decrease water use.
- For large overloads, the system may have to be expanded or a replacement system installed.

#### 8. Evaluate site and soil properties.

Information from a proper soil evaluation can determine if the site can be used to repair a drainfield that has failed.

- Determine the types of soil present. Use soil borings, textural determination, and other techniques to determine the type of soil.
- Complete a soil evaluation and fill out an evaluation sheet.
- Determine the appropriate loading rate, or acceptance rate, for the soil. This is the volume of effluent the soil can absorb in a day. Check the following items:
  - Soil depth,
  - Soil wetness,
  - Soil characteristics or morphology, restrictive horizons, changes in soil characteristics either with depth or over the drainfield area,

- Loading rate for the trench bottoms, loading rate for the entire area of the drainfield, which is the volume of effluent per square foot of the field, and
- Loading rate along trench length, volume of effluent per foot of trench.
- Determine which type of on-site system will fit the site and soil conditions and the available area.

#### 9. Note cut or excavated areas.

If topsoil has been removed in an area, the septic tank system will not operate properly. Usually, these areas have much less capacity to absorb and treat the effluent once the topsoil is gone.

- Try to find out if the system was placed in an area that had been excavated and the soil removed. Subsoils and saprolite are not the best soils for septic tank systems.
- Check for cut or excavated areas downslope from the system. Effluent may be coming to the surface in the cut area after it flows downhill from the drainfield.
- Old farming terraces upslope can trap rainwater causing the soil downslope to become saturated.

#### 10. Interpret information gathered.

At this stage, you should have most of the information that can be obtained. The information must be interpreted to determine the cause of the problem and whether the problem can be corrected. Some failing systems cannot be corrected.

- See if the information points to the cause of the problem. Keep well organized files of the information you have gathered. This information may help decide what is causing the problem.
- Discuss the situation and the information you have with your county environmentalists. Environmental health professionals have experience with septic tank systems.

### **Taking Corrective Action**

- If the problem has been identified, then it is time for corrective action. The following list contains actions that will correct many problems.
- The best thing to do in any system failure is to start a schedule of regular maintenance and operation checks. Homeowners rarely maintain their septic tank systems properly and maintenance can easily make the difference between a system with problems and one that functions well.
- If the plumbing or conveyance pipes are clogged, clean them out.
- If water leaks are overloading the septic tank system, then repair the leaking plumbing fixtures or pipes.
- If seasonal high water table saturates the soil around the drainfield, use subsurface tile drainage to lower the water table.
- If the system is being flooded by runoff from roof downspouts, change the downspouts to direct the runoff away from the drainfield.

- In situations where the tank is plugged with solids or the inlet or outlet is clogged because of solids in the tank, pumping the septic tank will help the system to function properly again.
- If mechanical or electrical parts have broken, replace the parts.
- If pipes have collapsed or trenches have filled in, then the pipes should be replaced and reinstalled.
- Broken conveyance pipes or laterals on pumped systems must be replaced.
- Leaking septic tanks and pump tanks must be repaired or replaced.
- In some cases, nothing can be done to correct the existing septic tank system, which means that the homeowner is in for big changes and probably high costs. There are some alternative to consider when whole systems must be repaired.
- The owner may be able to obtain an easement for use of a neighbor's property for an expanded or additional drainfield. This option depends greatly on the type of neighborhood and how close the houses are to each other.
- Be certain that smaller corrections will not fix the system before you go to larger system repairs. For instance, if there is only a small failure where water is ponding on the surface, then adding one or two trenches of the same size as the original trenches may be enough.
- If there is a large failure over most of the drainfield, the entire field will have to be replaced. Sometimes the old field will recover if it is not used for six months or a year, and is then put back into service.
- Another alternative is to install dual alternating drainfields, alternating the flow between the old field and the new field. The old field may recover in a few months and be ready for use when the flow is turned on again.
- Another piece of land may be purchased to install another or an expanded drainfield.
- Alternative wastewater disposal methods that might work on the property can be investigated.

After the system has been rehabilitated, follow-up on how the repaired system is functioning is necessary. Here are a few ideas for follow-up.

- Inspect the repaired system and review the operation and maintenance of the system. If the system is not being maintained or operated properly, it will fail again.
- Try to educate the owner and users of the system so that the system is not abused. Education can prevent another failed system.
- Be sure that the owners and users know what maintenance is necessary for the system. Try to find out if the maintenance is being done.
- Inspect the system periodically to check for recurring problems.
- Continue keeping records on the system for future needs. Keep well-organized files of all information. These files may help you or someone else in another situation with a failing system.

**PART III****REFERENCES**

Alexander, Donald J., Calvin Jones, and Paul Sandman 1992. "The Systematic Evaluation and Repair of Failing Drainfields in the Coastal Zone Area of Virginia." Virginia State Department of Health, Richmond, Virginia.

Environmental Protection Agency 1980. "Design Manual: Onsite Wastewater Treatment and Disposal Systems." Office of Water Program Operations, Washington, District of Columbia.

Hoover, M.T. 1990. "Soil Facts: Septic Systems and Their Maintenance." AG-439-13. North Carolina Agricultural Extension Service, North Carolina State University, Raleigh, North Carolina.

Lockwood, Dietershagen Associates 1997. "Septic Tank Systems." Clifton Park, New York.

North Carolina Department of Environment, Health and Natural Resources 1996. "On-Site Wastewater Management Guidance Manual." Raleigh, North Carolina.

7) Appendix 7 - Pipe Fittings

